

**HO**

1:87

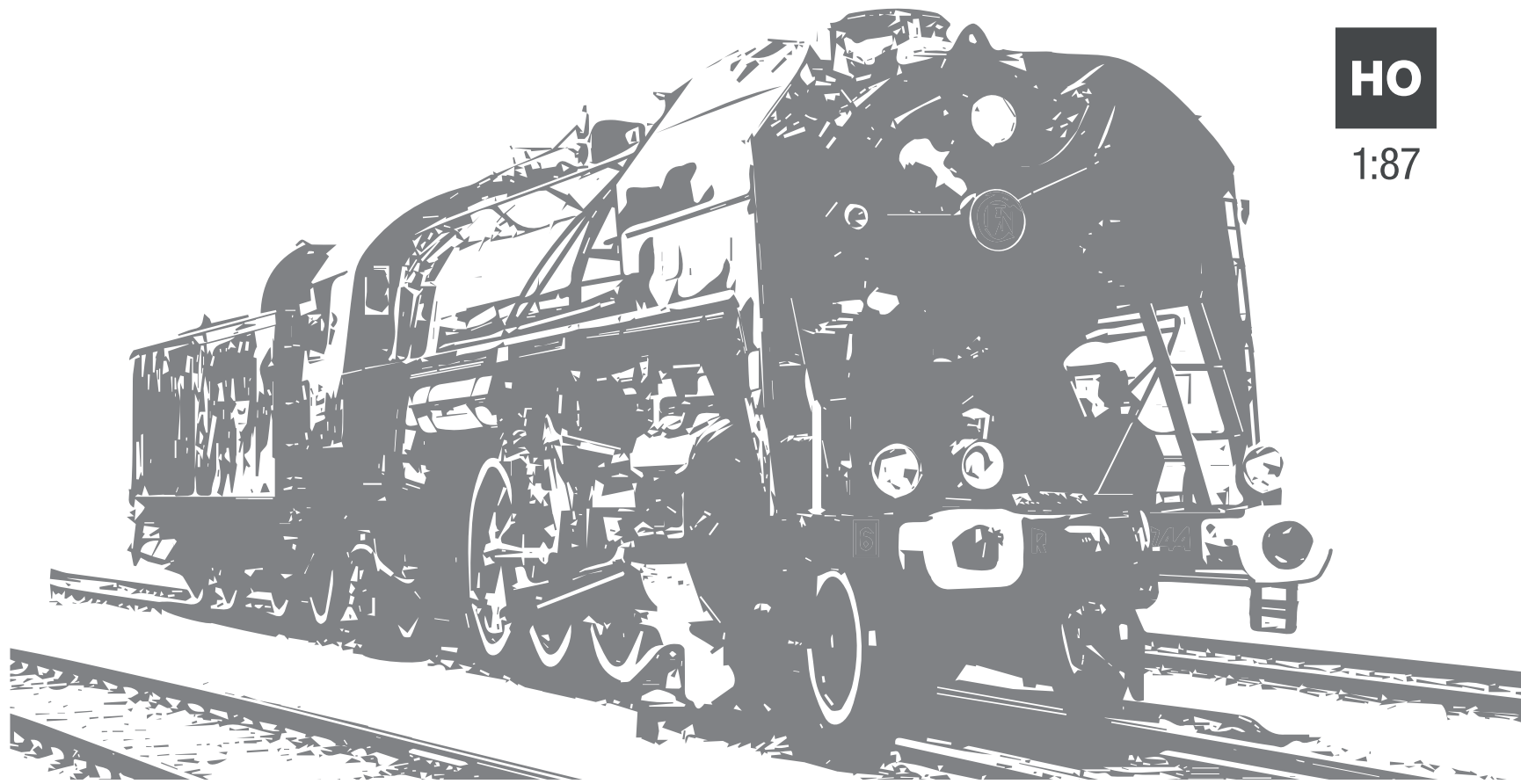

**Jouef®**

*Electrotren®*

**Rivarossi®**

**Lima®**

# 2024

*International  
Catalogue*



























# INDEX • Inhalt • Index • Indice • Índice

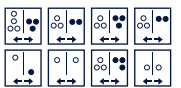





SHOWS & FAIRS . . . . .	7
JOUEF . . . . .	8
JOUEF LOISIRS . . . . .	70
MKD . . . . .	76
ELECTROTREN . . . . .	78
ELECTROTREN HOBBY . . . . .	112
RIVAROSSO . . . . .	118
LIMA EXPERT . . . . .	212
HEICO MODELL . . . . .	224
ACCESSORIES . . . . .	226
INDEX . . . . .	242

# Symbols • Zeichenerklärung • Symboles • Símbolos • Simboli

 <p>Motorized model, with digital DCC decoder Gleichstrommodell, digital mit DCC-Decoder Modèle motorisé pour courant continu avec décodeur DCC Modelo motorizado, con decodificador digital DCC Modello motorizzato in corrente continua, con decodificatore digitale</p>	 <p>Built-in interior details Inneneinrichtung eingebaut Aménagement intérieur Modelo con interiores detallados Modello con dettagli interni</p>	 <p>Plug for digital decoder, 21 pins (MTC) Lok mit 21-Decoder-Schnittstelle (MTC) Prise pour décodeur DCC 21 broches (MTC) Enchufe para receptor digital 21 pins (MTC) Presse NEM per decoder 21 pins (MTC)</p>	 <p>Detailed cabin interior Detaillierter Kabineninnenraum Intérieur détaillé de la cabine Interior detallado de la cabina Interni della cabina dettagliati</p>
 <p>Motorized model, with digital decoder and sound Gleichstrommodell, digital mit Sound Modèle motorisé pour courant continu avec décodeur DCC sonorisé Modelo motorizado, con decodificador digital y sonido Modello motorizzato in corrente continua, con sound decoder</p>	 <p>Built-in interior illumination Mit eingebauter Innenbeleuchtung Modèle avec éclairage intérieur Modelo con iluminación interior Modello con illuminazione interna</p>	 <p>Digital plug NEM 662 (Next 18) Digitalschnittstelle NEM 662 (Next 18) Prise NEM pour décodeur NEM 662 (Next 18) Enchufe para receptor digital NEM 662 (Next 18) Presse NEM per decoder 662 (Next 18)</p>	 <p>Metal die-cast chassis with plastic body shell Fahrwerk aus Metallspritzguss, Lokomotivgehäuse aus Kunststoff Châssis métallique avec carrosserie en plastique Chassis metálico con carrocería en plástico Telaio in metallo, corpo in plastica</p>
 <p>Motorized model for AC, with digital decoder Wechselstrommodell, digital Modèle motorisé pour système 3 rails, courant alternatif Modelo motorizado para AC, con decodificador digital Modello motorizzato in corrente alternata, con decodificatore digitale</p>	 <p>Illuminated number plate Nummernschild beleuchtet Immatriculation éclairée Matrícula iluminada Matricola illuminata</p>	 <p>Plug for digital decoder, 8 pins (NEM 652) Lok mit 8-poliger Decoder-Schnittstelle nach NEM 652 Prise pour décodeur DCC 8 broches (NEM 652) Enchufe para receptor digital 8 pins (NEM 652) Presse per decoder NEM 652</p>	 <p>Metal die-cast chassis with metal die-cast body shell Fahrwerk und Lokomotivgehäuse aus Metallspritzguss Châssis et carrosserie en métal Chasis y carrocería en metal Telaio in metallo, corpo in metallo</p>
 <p>Motorized model for AC, with digital decoder and sound Wechselstrommodell, digital mit Sound Modèle motorisé pour système 3 rails, courant alternatif avec décodeur digital sonorisé Modelo motorizado para AC, con decodificador digital y sonido Modello motorizzato in corrente alternata, con sound decoder</p>	 <p>Extending coupling mechanism Kurzkupplungs-Mechanismus eingebaut Attelages à élongation Con mecanismo elástico para enganche corto Gancio corto con cinematismo a norma NEM</p>	 <p>Plug for digital decoder, 6 pins (NEM 651) Lok mit 6-poliger Decoder-Schnittstelle nach NEM 651 Prise pour décodeur DCC 6 broches (NEM 651) Enchufe para receptor digital 6 pins (NEM 651) Presse per decoder NEM 651</p>	 <p>Motor with flywheel Motor mit Schwungrad Moteur avec volant d'inertie Motor con volante de inercia Motore con volano</p>
 <p>Model equipped with wheels for AC Wechselstrommodell Modèle équipée avec roues pour système 3 rails, courant alternatif Modelo equipado con ruedas para AC Modello dotato di ruote per corrente alternata</p>	 <p>American knuckle coupler Amerikanische Klauenkupplung Attelage américain Enganche americano Gancio americano</p>	 <p>Alimentazione da linea aerea Umschaltbar auf Oberleitungsbetrieb Prise de courant par caténaire fonctionnelle Pantógrfo con toma de corriente funcional Power supply can be switched to catenary</p>	 <p>Locomotive with white/red reversing headlights Spitzen- und Schlussbeleuchtung mit der Fahrtrichtung wechselnd Éclairage avec volant blanc/rouge Locomotora con luces reversibles blancas y rojas Locomotiva con luci reversibili bianche e rosse</p>
 <p>Overall length in mm Länge über Puffer in (mm) Longueur hors tampons (mm) Longitud entre topes (mm) Lunghezza fuori respingenti (mm)</p>	 <p>Motorized fan Elektrisch angetriebener Ventilator Ventilateur motorisé Ventilador motorizado Ventilatore motorizzato</p>	 <p>Sprung buffers Federpuffer Tampons avec ressort Topes con muelle Respingenti molleggiati</p>	 <p>New tooling / Tooling modification Formneuheit / Formvariante Nouvel outillage / Modification d'outillage Nuevo molde / Nueva modificación Nuovi stampi / Modifiche di stampo</p>

## Period

Epoche • Époque • Época • Epoca

	Period / Epoche / Époque / Época / Epoca I: 1848 - 1920
	Period / Epoche / Époque / Época / Epoca II: 1921 - 1940
	Period / Epoche / Époque / Época / Epoca III: 1941 - 1970
	Period / Epoche / Époque / Época / Epoca IV: 1971 - 1990
	Period / Epoche / Époque / Época / Epoca V: 1991 - 2006
	Period / Epoche / Époque / Época / Epoca VI: 2007 -

## Railway companies

Eisenbahnunternehmen • Compagnies ferroviaires • Compañías ferroviarias • Compagnie ferroviarie

	Deutsche Reichsbahn-Gesellschaft		Österreichische Bundesbahnen
	Deutsche Reichsbahn		RENFE, Red Nacional de los Ferrocarriles Españoles
	Deutsche Reichsbahn (ehem. DDR)		SNCF, Société Nationale des Chemins de Fer Français
	Deutsche Bundesbahn (ehem. BRD)		Ferrovie dello Stato
	Deutsche Bahn AG		Schweizerische Bundesbahnen

Descriptions and images are not contractual and may not conform exactly to production versions.

Bitte beachten Sie, dass mit dem Erscheinen dieses Katalogs alle vorherigen Kataloge ihre Gültigkeit verlieren. Produktänderungen nach Redaktionsschluss vorbehalten.

Les descriptions et les images ne sont pas contractuelles et peuvent ne pas correspondre exactement aux versions de production.

Las descripciones e imágenes no son contractuales y pueden no coincidir exactamente con las versiones de producción

Descrizioni e immagini non hanno valore contrattuale e possono variare dalle versioni prodotte.

# International Catalogue 2024

## English

Dear Modeller,

this catalogue is for you, who cannot get enough of trains. Thanks to precision and dedication, here at Hornby International the goal of excellence always comes first. At every step of their manufacture, from development to display on the shelves, our trains always achieve outstanding results.

And in 2024 expectations won't be disappointed!

Not only precision in finishing but internationality: Italy, France, Spain and Germany will be in your collection and on your model train layout.

Also this year, we have provided you with a wide range of products to choose from.

Locomotives, coaches, wagons are only part of what you'll get, the surprises of this 2024 will leave you speechless!

## Italiano

Caro fermodellista,

*questo catalogo è per te, che di treni non ne hai mai abbastanza. Grazie a rigore e dedizione, qui da Hornby International l'obiettivo di eccellenza è sempre al primo posto. In ogni fase della loro lavorazione, dallo sviluppo all'esposizione sugli scaffali, i nostri treni sanno sempre raggiungere risultati eccezionali. E nel 2024 le aspettative non verranno deluse!*

*Non solo precisione nelle finiture ma internazionalità: Italia, Francia, Spagna e Germania potranno essere nella tua collezione e sul tuo plastico. Anche quest'anno, abbiamo messo a tua disposizione una vasta gamma di prodotti tutti da scegliere.*

*Locomotive, carrozze, carri sono solo una parte di ciò che ti spetta, le sorprese di questo 2024 ti lasceranno a bocca aperta!*

## Français

Cher modéliste ferroviaire,

*Ce catalogue est pour vous, qui n'en avez jamais assez des trains. Grâce à la rigueur et au dévouement, ici, chez Hornby International, l'objectif d'excellence est toujours prioritaire. À chaque étape de leur fabrication, du développement à la présentation sur les étagères, nos trains obtiennent toujours des résultats exceptionnels.*

*Et en 2024, les attentes ne seront pas déçues ! Non seulement la précision de la finition, mais aussi l'internationalité : La France, l'Italie, l'Espagne et l'Allemagne seront dans votre collection et sur votre maquette. Cette année encore, nous vous avons fourni un large éventail de produits parmi lesquels choisir.*

*Locomotives, voitures, wagons ne sont qu'une partie de ce que vous obtiendrez, les surprises de ce 2024 vous laisseront sans voix !*

## Español

Estimado modelista,

*este catálogo es para ti, que no tienes suficiente con los trenes. Gracias al rigor y la dedicación, en Hornby International el objetivo de la excelencia es siempre la prioridad. En todas las etapas de su fabricación, desde el desarrollo hasta la exhibición en los estantes, nuestros trenes siempre logran resultados excepcionales.*

*Y en 2024, ¡las expectativas no serán decepcionadas!*

*No sólo precisión en los detalles, sino también en la internacionalidad: España, Alemania, Francia y Italia estarán en tu colección y en tu maqueta. Una vez más, este año hemos puesto a tu disposición una amplia gama de productos entre los que puedes elegir.*

*Las locomotoras, los coches y los vagones son sólo una parte de lo que obtendrás, ¡las sorpresas de este 2024 te dejarán sin palabras!*

## Deutsch

Lieber Modelleisenbahner,

*dieser Katalog ist für Sie, die Sie nie genug von Zügen haben können. Für uns ist die Modelleisenbahn eine Leidenschaft, genau wie für Sie.*

*Und daher möchten wir auch 2024 Ihren hohen Erwartungen an uns nicht enttäuschen.*

*Nicht nur die Liebe zum Detail ist was unsere Marken auszeichnet, auch die Internationalität: Egal ob Deutschland, Frankreich, Italien, Spanien, Osteuropa oder die USA – wir lieben Eisenbahnen aus der ganzen Welt.*

*Wir hoffen, dass wir Ihnen auch in diesem Jahr wieder eine breite Palette von interessanten Neuheiten vorstellen können.*

*Neue Lokomotiven, Reisezugwagen und Güterwagen sind nur ein Teil dessen, was auf Sie 2024 wartet.*

*Lassen Sie sich überraschen!*

A CLUB for every fan  
Un CLUB per ogni appassionato  
Un CLUB para cada aficionado  
Un CLUB pour chaque fan  
Ein CLUB für jeden Fan

**HORNBY  
HOBBIES**



**Rivarossi**  
C L U B

**Vantaggi con l'adesione al Club**

Punti sconto sul sito Hornby

Carro gratuito

Accesso gratuito a Hobby Model Expo

Catalogo internazionale Hornby

[www.rivarossi.com](http://www.rivarossi.com)

**CLUB**  
**Electrotren**

**Ventajas por ser socio del Club**

Promociones en la web de Hornby

Vagón exclusivo en escala N o H0

Revista del Club Electrotren

Catálogo Electrotren o Arnold

[www.clubelectrotren.com](http://www.clubelectrotren.com)



Jouef

Electrotren

Rivarossi

Lima

# 2024 SHOWS & FAIRS

FEB	MAR	APR	MAY	JUN	JUL	AUG	SEP	OCT	NOV
30jan-3 <b>Spielwarenmesse</b> Nuremberg		18-21 <b>Intermodellbau</b> Dortmund					20-24 <b>Modell-Hobby-Spiel</b> Leipzig		1-3 <b>Fascination Modellbau</b> Friedrichshafen
	16-17 <b>Expotren</b> Lleida	- <b>MartoTren</b> Barcelona							- <b>ExpoModelTren</b> Madrid
	9-10 <b>Model Expo Italy</b> Verona						27-29 <b>Model Expo</b> Novegro (Mi)		
							27-29 <b>Salon International du modélisme</b> Orléans		29-1 <b>Rail Expo</b> Dreux



# INDEX • Index

Locomotives à vapeur . . .	10
Locomotives Diesel . . . .	14
Locomotives électriques . .	24
Voitures. . . . .	36
Wagons . . . . .	50
Produits disponibles . . . .	64

<i>Steam locomotives. . . . .</i>	<i>10</i>
<i>Diesel locomotives. . . . .</i>	<i>14</i>
<i>Electric locomotives. . . . .</i>	<i>24</i>
<i>Coaches . . . . .</i>	<i>36</i>
<i>Wagons . . . . .</i>	<i>50</i>
<i>Available Products . . . . .</i>	<i>64</i>



[www.jouef.com](http://www.jouef.com)



Jouef est fier de vous présenter le tout nouveau catalogue 2024, riche de grandes nouveautés – à temps pour le 80e anniversaire ! La variété des trains à l'échelle proposée est l'atout majeur de Jouef. Vous trouverez tout ce dont vous avez besoin, locomotives, locomotives électriques, wagons de marchandises et voitures.

Toutes les époques sont représentées : des locomotives SNCF de la série 141R de l'époque III aux locomotives électriques de la série BB 36000 de l'époque V, en passant par les automotrices diesel de type RGP I de l'époque VI. Chaque amateur de modélisme ferroviaire aura le train de ses rêves avec Jouef !

Au-delà de la collection purement ferroviaire, Jouef répond aux besoins de tous avec MKD, pour des réglages parfaits. Pratiques à utiliser, les kits MKD compléteront votre diorama : si vous recherchez des bâtiments spéciaux, vous vous trouvez au bon endroit !









HJ2430/HJ2430S



SNCF

**SNCF, locomotive à vapeur 141 R 44, avec 3 feux avant et tender à charbon, livrée verte/noire, dépôt Sarreguemines, ép. III**

SNCF, Dampflokomotive 141 R 44, mit drittem Spitzenlicht und Kohle-Tender in grün/schwarzer Lackierung, Depot Sarreguemines, Ep. III

SNCF, locomotiva a vapore 141 R 44, con terzo fanale di testa e tender a carbone, livrea verde/nera, deposito di Sarreguemines, ep. III

SNCF, locomotora de vapor 141 R 44, con tres luces frontales y tender de carbón, decoración verde/negra, depósito de Sarreguemines, ép. III

SNCF, steam locomotive 141 R 44, with 3<sup>rd</sup> headlamp and coal tender, green/black livery, dépôt Sarreguemines, period III



HJ2431/HJ2431S



SNCF

**SNCF, locomotive à vapeur 141 R 484, avec 3 feux avant et tender à charbon, livrée noire, dépôt Hausbergen, ép. III**

SNCF, Dampflokomotive 141 R 484, mit drittem Spitzenlicht und Kohle-Tender in schwarzer Lackierung, Depot Hausbergen, Ep. III

SNCF, locomotiva a vapore 141 R 484, con terzo fanale di testa e tender a carbone, livrea nera, deposito di Hausbergen, ep. III

SNCF, locomotora de vapor 141 R 484, con tres luces frontales y tender de carbón, decoración negra, depósito de Hausbergen, ép. III

SNCF, steam locomotive 141 R 484, with 3<sup>rd</sup> headlamp and coal tender, black livery, dépôt Hausbergen, period III







HJ2432/HJ2432S



**Locomotive à vapeur 141 R 420, avec tender à charbon, ép. V**

Dampflokomotive 141 R 420, mit Kohle-Tender, Ep. V  
Locomotiva a vapore 141 R 420, tender a carbone, ep. V  
Locomotora de vapor 141 R 420, tender de carbón, ép. V  
Steam locomotive 141 R 420, coal tender, period V



HJ2433/HJ2433S



**Locomotive à vapeur 141 R 1244, grande capacité de carburant du tender, livrée verte/noire avec roues blanches, ép. V**

Dampflokomotive 141 R 1244, Tender mit großem Ölbunker, in grün/schwarzer Lackierung mit weißen Radreifen, Ep. V  
Locomotiva a vapore 141 R 1244, con tender per olio combustibile ad alta capacità, livrea verde/nera e cerchioni bianchi, ep. V  
Locomotora de vapor 141 R 1244, tender de Fuel-Oil de alta capacidad, decoración verde/negra con ruedas blancas, ép. V  
Steam locomotive 141 R 1244, big capacity fuel tender, green/black livery with white wheel rings, period V

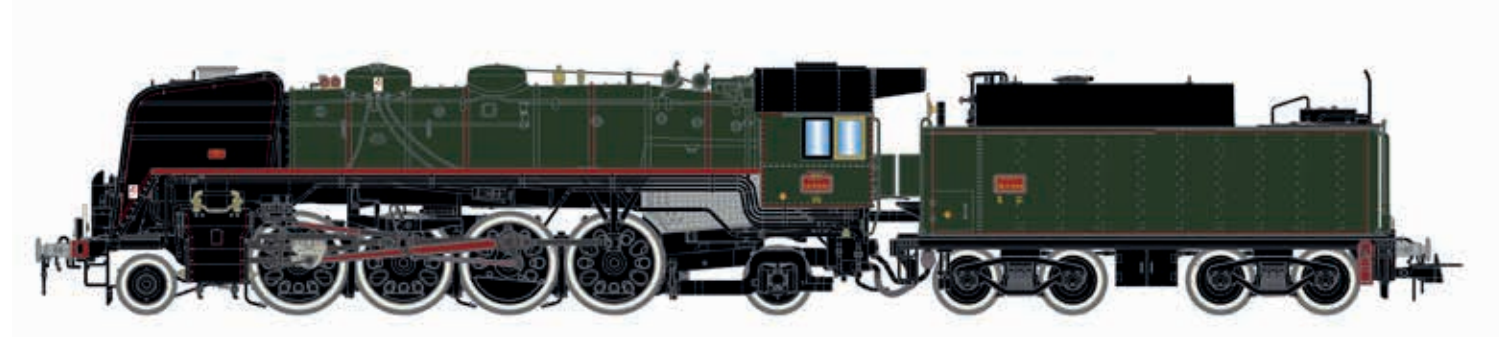



# 040 D





**SNCF, locomotive à vapeur 2-040 D 65, dépôt de Calais, ép. III**

SNCF, Schleppenderdampflokomotive 2-040 D 65, Depot Calais, Ep. III

SNCF, locomotiva a vapore 2-040 D 65, deposito di Calais, ep. III

SNCF, locomotora de vapor 2-040 D 65, depósito de Calais, ép. III

SNCF, steam locomotive with tender 2-040D 65, depot Calais, ep. III

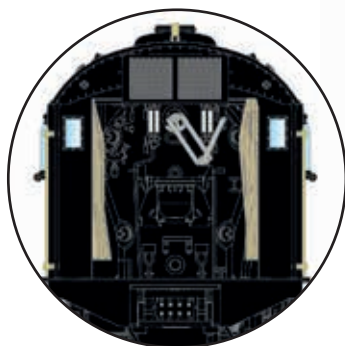

Détails de l'intérieur de la cabine

- Con forno scoppiettante
- Mit flackerner Feuerbüchse
- Avec boîte à feu scintillant
- Con fogón parpadeand
- With flickering firebox

**Locomotive à vapeur 040 D**

Ces locomotives appartiennent au type G81 des Chemins de fer royaux prussiens (KPEV), construits en Allemagne entre 1913 et 1921, à plus de 5.000 exemplaires.

Après l'armistice de 1918, plus de 1.500 locomotives furent transférées vers la Belgique, la Pologne et la France.

En France, les sociétés Alsace-Lorraine, Compagnie de l'Est, Compagnie du Nord, ETAT, Paris-Orléans, MIDI et PLM ont reçu un grand nombre de ces machines.

Cependant, à partir de 1946, seules les régions Nord et Est utilisèrent ces machines en service. Lors de leur utilisation, ils servaient de trains de marchandises.

La 1-040 D 260 SNCF (ex G8.1 5260 Alsace-Lorraine) est la dernière machine en service et rayonnée le 1er juillet 1966.

Ces locomotives disposaient d'un tender à 3 vitesses d'une capacité de 16,5 m<sup>3</sup> d'eau et de 7 tonnes de charbon, une puissance de 934 kW et une vitesse maximale de 50 km/h.

# LES RGP I

## Les Rames à Grand Parcours

La SNCF commande 20 rames RGP en 1950. Equipés du moteur MGO, les RGP I furent construites par la société De Dietrich pour les motrices et les Etablissements Brissonneau & Lotz pour les remorques.

Dérivés des RGP 2 X 2700 sur le plan structure et des X 2800 pour la partie mécanique, les ensembles ferroviaires monomoteurs dits Rame à grand parcours RGP I ont comporté deux variantes: une série en livrée vert et crème (X 2720) utilisée, comme les RGP 2 pour des trains du service intérieur; une série, en livrée TEE rouge carmin et crème (X 2770), ne comportant que des premières classes et utilisées à l'origine sur des trains Trans Europ Express en France et à l'étranger.

Entre 1985 et 1991, les deux séries de RGP I furent modernisées avec, entre autres, la modification de leur face avant renforcée et aménagements de type Z2 avec cabines de conduite modernisée; elles revêtirent progressivement des couleurs gris clair avec bandeaux jaune, bleu ou rouge en fonction des livrées TER choisies par les régions.

À partir de 1957, les X 2770 assurèrent les premières relations Trans Europ Express (TEE) en livrée TEE comme « l'Arbalète » de Paris-Est à Zurich via Mulhouse et Bâle, « l'Étoile du Nord » de Paris-Nord à Bruxelles via Lille ou « Le Mont-Cenis » de Lyon à Turin via Chambéry et Modane. Après leur retrait du service TEE en 1965, elles assurèrent de grandes relations transversales, en première classe avec supplément, comme « le Catalan » de Genève à Cerbère via Grenoble, Avignon et Montpellier ou « Le Rhodanien » de Genève à Marseille via Grenoble et Avignon.

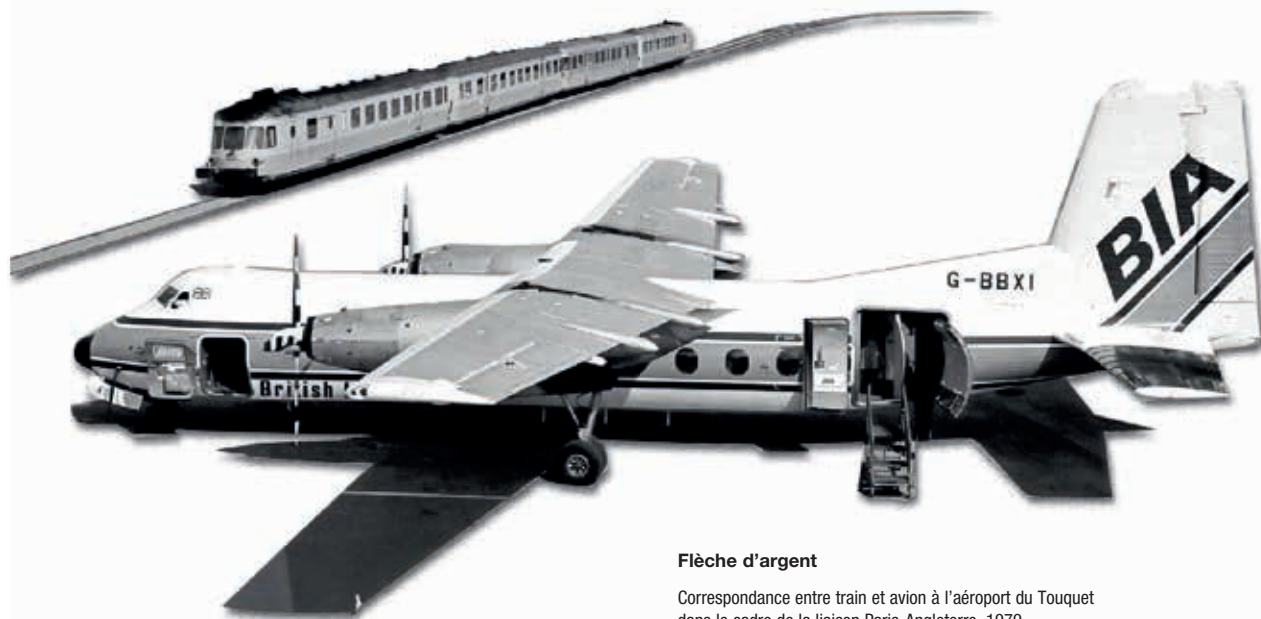

### Flèche d'argent

Correspondance entre train et avion à l'aéroport du Touquet dans le cadre de la liaison Paris-Angleterre, 1979.



HJ2461/HJ2461S



SNCF

NEW

### SNCF, autorail diesel RGP I avec remorque, livrée TEE rouge/beige, ép. III

SNCF, Dieseltriebwagen RGP I mit Beiwagen in rot/beiger TEE-Farbgebung, Ep. III

SNCF, automotrice diesel RGP I con rimorchio, livrea TEE rosso/beige, ep. III

SNCF, automotor diesel RGP I con remolque, decoración TEE rojo/beige, ép. III

SNCF, diesel railcar RGP I with trailer in red/beige TEE livery, ep. III

## Le TEE « Parsifal »

Le TEE 155/190 Parsifal était, de par sa position horaire, le train opposé au TEE Paris-Ruhr circulant déjà depuis l'horaire d'été 1957 et fut introduit le 03.10.1957, 4 jours après l'introduction de l'horaire d'hiver 1957/58. Il quittait Paris tôt le matin et rentrait le soir de Dortmund.

A partir de l'été 1958, le train s'arrêta également à Düsseldorf, Duisburg et Bochum, comme son homologue, mais l'arrêt à Herbesthal fut supprimé. Pour l'horaire d'été 1959, l'itinéraire fut raccourci à Düsseldorf et l'arrêt à Herbesthal fut repris un an plus tard. Jusqu'à l'été 1960, la prestation était assurée par des automotrices RGP I en rotation d'un jour.





HJ2462/HJ2462S



SNCF

NEW

**SNCF, autorail diesel RGP I avec remorque, livrée originale vert/beige, ép. IV**

SNCF, Dieseltriebwagen RGP I mit Beiwagen, original grün-beige Farbgebung, Ep. IV

SNCF, automotrice diesel RGP I con rimorchio, livrea originale verde/beige, ep. IV

SNCF, automotor diesel RGP I con remolque, decoración verde/beige, ép. IV

SNCF, diesel railcar RGP I with trailer, original green/beige livery, ep. IV



© Jean-Philippe Thernisien



HJ2463/HJ2463S



SNCF

NEW

**SNCF, autorail diesel RGP I avec remorque, livrée gris/orange « alpazur », ép. IV**

SNCF, Dieseltriebwagen RGP I mit Beiwagen in grau-oranger Farbgebung „Alpazur“, Ep. IV

SNCF, automotrice diesel RGP I con rimorchio, livrea grigio/arancio “alpazur”, ep. IV

SNCF, automotor diesel RGP I con remolque, decoración gris/naranja “Alpazur”, ép. IV

SNCF, diesel railcar RGP I with trailer in grey/orange livery “alpazur”, ep. IV



© Jean-Philippe Thernisien





HJ2436/HJ2436S



SNCF

NEW

**SNCF, autorail diesel classe X 73500 « Imaginalsace », ép. VI**

SNCF, Dieseltriebwagen der Reihe X 73500 in neuer Farbgebung „Imaginalsace“, Ep. VI

SNCF, automotrice diesel classe X 73500 “Imaginalsace”, ep. VI

SNCF, automotor diesel X 73500, decoración “Imaginalsace”, ép. VI

SNCF, diesel railcar class X 73500 “Imaginalsace”, ep. VI



© François Pejón



HJ2437/HJ2437S



SNCF

NEW

**SNCF, autorail diesel classe X 73500 « La Région », ép. VI**

SNCF, Dieseltriebwagen der Reihe X 73500 „La Region“, Ep. VI

SNCF, automotrice diesel classe X 73500 “La Region”, ep. VI

SNCF, automotor diesel X 73500, decoración “La Region”, ép. VI

SNCF, diesel railcar class X 73500 “La Region”, ep. VI



© François Pejón

**SNCF, autorail diesel classe X 73500 « Nouvelle Aquitaine » (Bordeaux), ép. VI**

SNCF, Dieseltriebwagen der Reihe X 73500 „Nouvelle Aquitaine“ (Bordeaux), Ep. VI

SNCF, automotrice diesel classe X 73500 “Nouvelle Aquitaine” (Bordeaux), ep. VI

SNCF, automotor diesel X 73500, decoración “Nouvelle Aquitaine” (Bordeaux), ép. VI

SNCF, diesel railcar class X 73500 “Nouvelle Aquitaine” (Bordeaux), ep. VI



© François Pejon

**Les ATER X 73500**

Construits par Alstom-De Dietrich et Alstom LHB (Linke-Hofmann-Busch) cotraitant du précédent, les nouveaux venus, d'une longueur hors norme de 28,90 m, montés sur deux bogies avec deux portes de 1,30 m par faces à accès surbaissé favorisant le transport des personnes handicapées, sont mus par deux moteurs diesels MAN D 2866 LUH 21 à six cylindres en ligne, développant ensemble 514 kW, disposés horizontalement sous les cabines de conduite. Des engins proches circulent sur le réseau allemand (VT 641).

- Deux motor diesel MAN
- Disposition des essieux A1 - A1
- Poids: 48t.
- Longueur 28,90m
- Traction: hydrodynamique
- Vitesse maximale: 140 km/h.
- Construction: 1999 à 2004
- Nombre d'exemplaires: 312 + 6 ex CFL



© Michael Torregrossa



HJ2464/HJ2464S



SNCF

**NEW**

**SNCF, locomotive diesel-électrique BB 67613, livrée rouge « Capitole », ép. VI**

SNCF, vierachsige dieselelektrische Mehrzwecklokomotive BB 67613 in roter „Capitole“-Farbgebung, Ep. VI

SNCF, locomotiva diesel-elettrica BB 67613, livrea rossa "Capitole", ep. VI

SNCF, locomotora diesel BB 67613, decoración rojo "Capitole", ép. VI

SNCF, diesel-electric locomotive BB 67613 in red "Capitole" livery, ep. VI



HJ2465/HJ2465S



SNCF

**NEW**

**SNCF Infra, locomotive diesel-électrique BB 667548, livrée jaune INFRA, ép. VI**

SNCF Infra, Diesellokomotive BB 667548, gelbe Farbgebung, Ep. VI

SNCF Infra, locomotiva diesel-elettrica BB 667548, livrea gialla INFRA, ep. VI

SNCF Infra, locomotora diesel BB 667548, decoración amarillo, ép. VI

SNCF Infra, diesel-electric locomotive BB 667548, yellow livery, ep. VI







HJ2342/HJ2342S



SNCF

NEW

**SNCF, locomotive diesel BB 467460 à parois latérales lisses, livrée FRET, ép. VI**

SNCF, Diesellokomotive BB 467460 mit flachen Seitenwänden in FRET-Farbgebung, Ep. VI

SNCF, locomotiva diesel BB 467460 con pareti laterali lisce, livrea FRET, ep. VI

SNCF, locomotora diesel BB 467460, decoración "FRET", ép. VI

SNCF, diesel locomotive BB 467460 with flat lateral walls in FRET livery, ep. VI



HJ6252

HJ4183

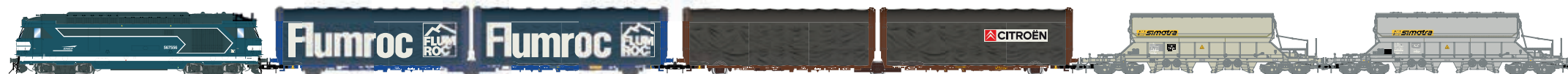

HJ2446

HJ6252

HJ6253

HJ6229



HJ2342

HJ6228

HJ6228

HJ6230

HJ6230

HJ6282



HJ2446/HJ2446S



SNCF

### SNCF, locomotive diesel BB 567556, livrée bleue avec logo « Casquette », ép. V

SNCF, Diesellokomotive BB 567556 in blauer Lackierung mit „Casquette“-Logo, Ep. V

SNCF, locomotiva diesel BB 567556, livrea blu con logo "Casquette", ep. V

SNCF, locomotora diésel BB 567556, decoración azul con logo «Casquette», ép. V

SNCF, diesel locomotive BB 567556, blue livery with "Casquette" logo, period V



Bogies sans graisseur



pare-soleil avant

#### Points forts du nouveau modèle Jouef

- Les deux ventilateurs de refroidissement sont entraînés et peuvent être commandés séparément en mode numérique
- Éclairage intérieur dans la cabine de la conduit
- Figurine de conducteur de locomotive et stores pare-soleil dans la cabine de conduite
- Feux blancs et feux rouges commutables séparément en mode digital
- Deux bogies moteurs
- Prises de courant sur les 8 roues de la locomotive
- Interface digitale NEM 660 (MTC 21 broches)
- Moteur de haute performance à cinq pôles avec volants d'inertie
- Mécanisme d'attelage court aux deux extrémités de la locomotive
- Boîtiers NEM 362 pour tête d'attelage interchangeable aux deux extrémités de la locomotive
- Rayon minimal d'inscription en courbe : 356,5 mm



figurine de conducteur



Ventilateurs fonctionnels



HJ2447/HJ2447S



SNCF

**SNCF, locomotive diesel BB 167424, livrée « Multiservice », ép. VI**

SNCF, Diesellokomotive BB 167424 in „Multiservice“-Lackierung, Ep. VI

SNCF, locomotiva diesel BB 167424, livrea "Multiservice", ep. VI

SNCF, locomotora diésel BB 167424, decoración azul «Multiservice», ép. VI

SNCF, diesel locomotive BB 167424, "Multiservice" livery, period VI

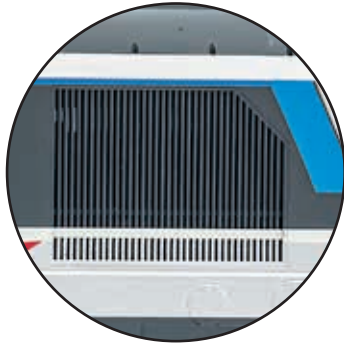

Calandre modifiée



HJ2448/HJ2448S



SNCF

**SNCF, locomotive diesel BB 67210, livrée jaune/blanche, « Infra Structure », ép. V**

SNCF, Diesellokomotive BB 67210 in gelb/weißer Lackierung, „Infra Structure“, Ep. V

SNCF, locomotiva diesel BB 67210, livrea gialla/bianca, "Infra Structure", ep. V

SNCF, locomotora diésel BB 67210, decoración amarillo/blanca, «Infra Structure», ép. V

SNCF, diesel locomotive BB 67210, yellow/white livery, "Infra Structure", period V



Bogies corrects





# Vossloh DE 18

## Vossloh DE 18

La Vossloh DE 18 est une locomotive Diesel de Vossloh Locomotives construite depuis 2010. Elle développe une puissance maximale de 1 800 kW et atteint une vitesse maximale de 120 km/h. Elle est commandée en 2016 par Akiem pour remplacer les BB 67200 de SNCF Réseau sous la désignation de BB 79000.

La DE 18 est une locomotive diesel à transmission électrique d'une puissance de 1 800 kW, pour une vitesse entre 70 et 120 km/h et son moteur est un MTU de 12 cylindres en V inclinés à 90°, pour un poids de 7.85 tonnes. Elle fonctionne à faible émission et faible consommation. Pour certaines utilisations de rénovations ferroviaires, elle peut rouler à vitesse de marche constante. Elle est également utilisable pour la maintenance sur les lignes à grande vitesse en France.



Photo: Joachim Lütz





HJ2439/HJ2439S



SNCF Réseau

NEW

**Akiem/SNCF Réseau, locomotive diesel BB 79000 (Vossloh DE 18), livrée jaune/gris, ép. VI**

Akiem/SNCF Réseau, Diesellokomotive der Reihe BB 79000 (Vossloh DE 18) in gelb-grauer Farbgebung, Ep. VI

Akiem/SNCF Réseau, locomotiva diesel BB 79000 (Vossloh DE 18), livrea gialla/grigia, ep. VI

Akiem/SNCF Réseau, locomotora diesel Vossloh DE 18, decoración amarillo/gris, ép. VI

Akiem/SNCF Réseau, diesel locomotive class BB 79000 (Vossloh DE 18), yellow/grey livery, ep. VI

**Points forts du nouveau modèle Jouef**

- Nouveaux moules
- Moteur de haute performance à cinq pôles avec volants d'inertie
- Deux bogies moteurs
- Prises de courant sur les 8 roues de la locomotive
- Éclairage intérieur dans la cabine de la conduit
- Écrans éclairés dans les tableaux de bord de la cabine de conduite
- Inversion des feux blancs avec le sens de la marche en mode analogique
- Inversion des feux rouges avec le sens de la marche en mode analogique
- Feux blancs et feux rouges commutables séparément en mode digital
- Interface digitale NEM 660 (MTC 21 broches)
- Châssis en zamak
- Carrosserie en plastique de haute qualité
- Mécanisme d'attelage court aux deux extrémités de la locomotive
- Boîtiers NEM 362 pour tête d'attelage interchangeable aux deux extrémités de la locomotive
- Rayon minimal d'inscription en courbe : 356,5 mm

© Alexander Leroy



HJ2440/HJ2440S



COLAS RAIL

NEW

**COLAS RAIL, locomotive diesel Vossloh DE 18, livrée orange/jaune, ép. VI**

COLAS RAIL, Diesellokomotive Vossloh DE 18 in orange-gelber Farbgebung, Ep. VI

COLAS RAIL, locomotiva diesel Vossloh DE 18, livrea arancio/gialla, ep. VI

COLAS RAIL, locomotora diesel Vossloh DE 18, decoración naranja/amarillo, ép. VI

COLAS RAIL, diesel locomotive Vossloh DE 18, orange/yellow livery, ep. VI

© Patrick Sambourg



# TGV®

## Train à Grande Vitesse

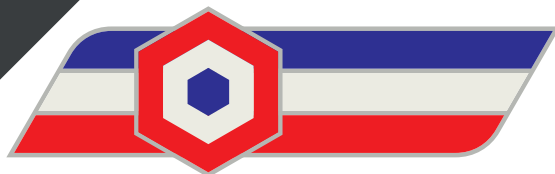

*Edition Inauguration  
22 Septembre 1981*



HJ2425/HJ2425S



SNCF

**SNCF, coffret de 4 unités, TGV Sud-Est, 1981 version inaugurale, ép. IV**

SNCF, 4-tlg. Set, TGV Sud-Est, 1981 Eröffnungsversion, Ep. IV

SNCF, set di 4 unità, TGV Sud-Est, versione inaugurale 1981, ep. IV

SNCF, set de 4 unidades, TGV Sud-Est, versión inaugural 1981, ép. IV

SNCF, 4-unit set, TGV Sud-Est, inaugural version 1981, period IV



HJ3014



SNCF

**SNCF, coffret supplémentaire de 3 voitures TGV Sud-Est, 1981 version inaugurale, composé de 1 voiture de 1ère classe et 1 voiture bar, ép. IV**

SNCF, 3-tlg. Ergänzungset TGV Sud-Est, 1981 Eröffnungsversion, bestehend aus 2 x 1.Kl. Wagen und 1 x Barwagen, Ep. IV

SNCF, set di 3 carrozze aggiuntive, TGV Sud-Est, versione inaugurale 1981, composto da 2 carrozze di 1a classe e 1 carrozza bar, ep. IV

SNCF, set de 3 unidades adicionales, TGV Sud-Est, versión inaugural 1981, compuesto de 2 coches de primera clase y 1 coche cafetería, ép. IV

SNCF, 3-unit additional set of TGV Sud-Est coaches, inaugural version 1981, including 2 1st class coaches and 1 bar coach, period IV



Fotomontage / Fotomontaje / Photomontage / Fotomontaggio

#### Points forts du nouveau modèle Jouef

- Nouvelle face avant de la locomotive avec essuie-glaces rapportés séparément (pièces photodécoupées en acier inoxydable)
- Bogies en version originale avec ressorts hélicoïdaux
- Les deux extrémités des voitures intermédiaires en version originale
- Pantographes entièrement réalisés en métal
- Train baptisé « Tergnier »



Fotomontage / Fotomontaje / Photomontage / Fotomontaggio



HJ3015

IV

630

← →

T

K

SNCF

#### SNCF, coffret supplémentaire de 3 voitures TGV Sud-Est, 1981 version inaugurale, composé de 3 voitures de 2ème classe, ép. IV

SNCF, 3-tlg. Ergänzungssset TGV Sud-Est, 1981 Eröffnungsversion, bestehend aus 3 x 2.Kl. Wagen, Ep. IV

SNCF, set di 3 carrozze aggiuntive, TGV Sud-Est, versione inaugurale 1981, composto da 3 carrozze di 2a classe, ep. IV

SNCF, set de 3 unidades adicionales, TGV Sud-Est, versión inaugural 1981, compuesto de 3 coches de segunda clase, ép. IV

SNCF, 3-unit additional set of TGV Sud-Est 2nd class coaches, inaugural version 1981, period IV



Fotomontage / Fotomontaje / Photomontage / Fotomontaggio



HJ2451/HJ2451S



SNCF

**SNCF, coffret de 4 unités, TGV Duplex Carmillon, composé de locomotive motorisé, locomotive sans motor et 2 voitures, ép. VI**

SNCF, 4-tlg. Set, TGV Duplex Carmillon, bestehend aus 1 angetriebenem, 1 nicht angetriebenem und 2 Zwischenwagen, Ep. VI

SNCF, set di 4 unità, TGV Duplex Carmillon, composto da locomotiva motorizzata, locomotiva folle e 2 carrozze, ep. VI

SNCF, set de 4 unidades, TGV Duplex Carmillon, compuesto de locomotora motorizada, locomotora sin motor y 2 coches, ép. VI

SNCF, 4-unit set, TGV Duplex Carmillon, including motorized head, dummy head and 2 end coaches, period VI

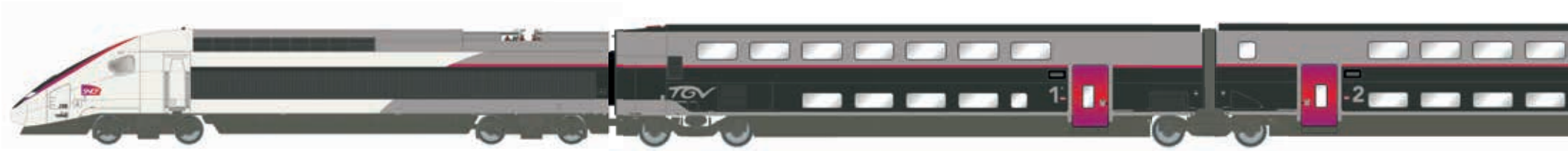

HJ3016



SNCF

**SNCF, coffret supplémentaire de 3 voitures, TGV Duplex Carmillon, composé de 2 voitures de ex 1ère classe et 1 voiture bar, ép. VI**

SNCF, TGV Duplex Carmillon, 3-tlg. Ergänzungset, bestehend aus 2 x ehem. Wagen 1. Klasse sowie einem Barwagen, Ep. VI

SNCF, set di 3 carrozze aggiuntive, TGV Duplex Carmillon, composto da 2 carrozze ex 1a classe e 1 carrozza bar, ep. VI

SNCF, set de 3 coches adicionales, TGV Duplex Carmillon, compuesto de 2 coches ex 1a clase e 1 coche cafetería, ép. VI

SNCF, 3-unit additional set of TGV Duplex Carmillon coaches, including 2 x ex 1st class coaches and 1 x bar coach, period VI

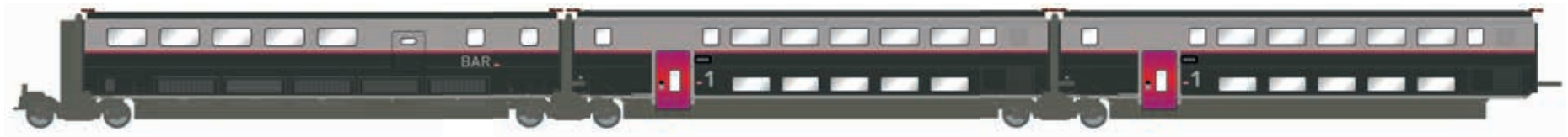



### La livrée Carmillon

Cette livrée est inspirée de la livrée du même nom apparue en 2011 sur des TGV PSE. Elle a été appliquée sur quelques locomotives BB 26000 portant la livrée grise<sup>13</sup>. Elle a l'avantage d'être facile à peindre, sans remise en peinture onéreuse. La livrée Carmillon est à base de gris, faces noires et bandes Carmillon et est un dégradé de couleurs, spécialement créé pour la SNCF à partir de rouge carmin et de rouge vermillon<sup>14</sup>.



© Francois Pejon



HJ3017 VI 630 € K SNCF

#### SNCF, coffret supplémentaire de 3 voitures, TGV Duplex Carmillon, composé de 3 voitures de ex 2ème classe, ép. VI

SNCF, TGV Duplex Carmillon, 3-tlg. Ergänzungsset, bestehend aus drei Zwischenwagen (ehem. 2. Klasse), Ep. VI

SNCF, set di 3 carrozze aggiuntive, TGV Duplex Carmillon, composto da 3 carrozze ex 2a classe, ep. VI

SNCF, set de 3 coches adicionales, TGV Duplex Carmillon, compuesto de 3 coches ex 2a clase, ép. VI

SNCF, 3-unit additional set of TGV Duplex Carmillon coaches, including 3 x ex 2nd class coaches, period VI





Photo: Nicolas Stambach 

### Les BB 26000

Après la livraison en 1986 des dernières BB 22200, la SNCF s'apprête à recevoir une nouvelle série de locomotives bicourant universelles, c'est-à-dire capables de tracter aussi bien des trains de voyageurs rapides à 200 km/h que des trains de marchandises lourds.

Ces machines doivent donc avoir une grande puissance disponible aussi bien sous 1,5 kV continu que sous 25 kV 50 Hz. Elles devaient être capables de remorquer un train de voyageurs de 750 tonnes (16 voitures) à 200 km/h en rampe de 2.5 ‰ ou un train de fret de 2050 tonnes à 80 km/h en rampe de 8.8‰. Le type de motorisation retenu est le même que celui des TGV Atlantique développés à la même époque: le moteur synchrone. À partir des essais réalisés sur les prototypes BB 20011-20012, les cinq premières machines (machines de présérie) sont livrées en 1988. Leur puissance de 5 600 kW n'atteint pas celle des CC 6500 avec leurs 5 900 kW, mais elles sont beaucoup plus légères (90 t au lieu de 116 t).

La 26001 sort d'usine début 1988 et est livrée le 1er avril 1988. Suivront les 26002 (6 mai), 26003 (10 mai), 26004 (1er juillet) et 26005 (1er septembre). Il y aura de longues années de livraisons intensives, avec jusqu'à quatre machines par mois.

Les cinq dernières 26000 seront livrées en 1998, la toute dernière (26234) étant mise en service le 23 juillet 1998.

Afin de rester à proximité relative de l'usine Alstom de Belfort, l'ensemble des locomotives de la série a été livré au dépôt de Dijon-Perrigny où le service après-vente Alstom avait pris place, puis réparti sur deux autres dépôts, Lens et Villeneuve.

Le caractère de machine universelle a très rapidement été mis en œuvre, avec la traction de trains de voyageurs à 200 km/h (dont le TER 200 d'Alsace et Interloire), et des trains de marchandises, notamment entre le Nord-Est et le Sud-Est.

Sans modification notable des services assurés, un petit parc VFE de vingt Sybic a été créé à Toulouse, en décembre 2004, et a été supprimé le 5 juillet 2009 avec le regroupement des Sybic toulousains à Villeneuve. Un groupe de machines Fret a été muté à Avignon dès décembre 2003, pour compenser le départ des BB 27000 regroupées dans le Nord et l'Est, respectivement au sein des dépôts de Lens et de Thionville.

En décembre 2007, les quatorze machines affectées au TER Alsace ont été mutées de Dijon-Perrigny à Strasbourg, et sont à présent équipées pour la réversibilité.



HJ2443/HJ2443S



SNCF

### SNCF, locomotive électrique BB 26212 avec 3 feux avant, livrée grise/orange avec logo « Casquette », ép. IV-V

SNCF, Elektrolokomotive BB 26212 mit drittem Spitzenlicht in grau-oranger Farbgebung mit „Casquette“-Logo, Ep. IV-V

SNCF, locomotiva elettrica BB 26212 con terza luce di testa, livrea grigia/arancio con logo "Casquette", ep. IV-V

SNCF, locomotora eléctrica BB 26212 con tercer foco frontal, decoración gris/naranja con logo "Casquette", ép. IV-V

SNCF, electric locomotive BB 26212 with 3rd headlight, grey/orange livery with "Casquette" logo, ep. IV-V



### BB 26212

De construction et à partir de la BB 26188, les SYBIC reçoivent, en conformité avec la réglementation européenne, un troisième feu frontal afin d'éviter de les confondre avec un véhicule routier. Le logo « Casquette » apparu en 1995, est toujours positionné à droite. La BB 26212 a été mise en service le 17 octobre 1996.

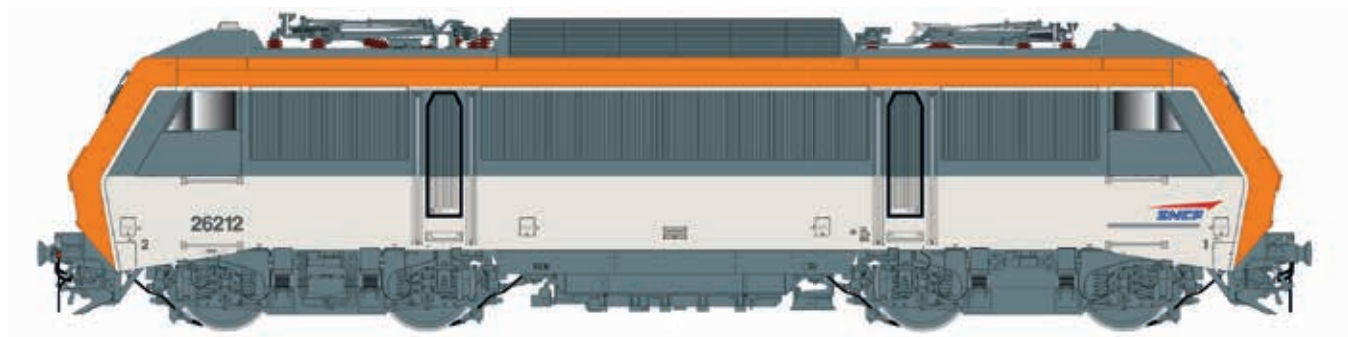



HJ2444/HJ2444S



SNCF

**SNCF, locomotive électrique BB 26056, livrée grise/rouge, « Technicentre Industriel Oullins », ép. VI**

SNCF, Elektrolokomotive BB 26056 in grau-roter Farbgebung, „Technicentre Industriel Oullins“, Ep. VI

SNCF, locomotiva elettrica BB 26056, livrea grigia/rossa, “Technicentre Industriel Oullins”, ep. VI

SNCF, locomotora eléctrica BB 26056, decoración gris/roja “Technicentre Industriel Oullins”, ép. VI

SNCF, electric locomotive BB 26056, grey/red livery, “Technicentre Industriel Oullins”, ep. VI

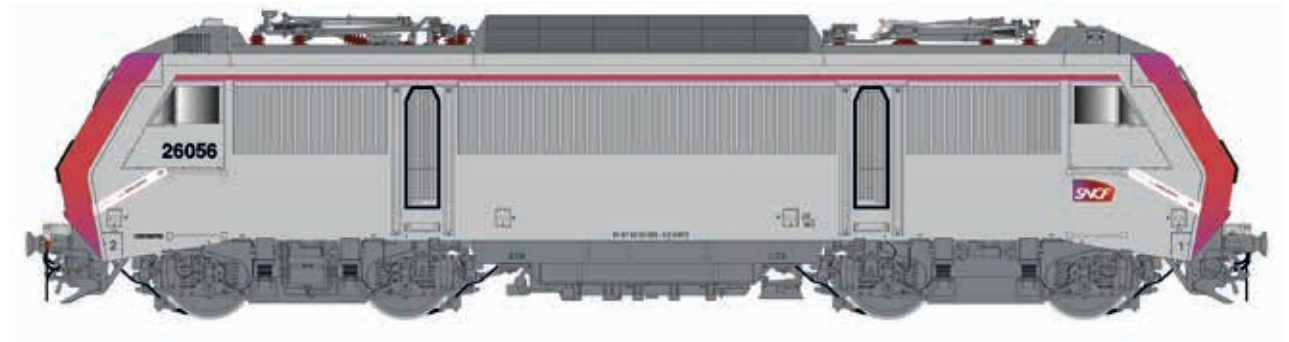

HJ2445/HJ2445S



SNCF

**SNCF, locomotive électrique BB 26144, livrée « TER Grand Est », ép. VI**

SNCF, Elektrolokomotive BB 26144 in „TER Grand Est“-Farbgebung, Ep. VI

SNCF, locomotiva elettrica BB 26144, livrea “TER Grand Est”, ep. VI

SNCF, locomotora eléctrica BB 26144, decoración “TER Grand Est”, ép. VI

SNCF, electric locomotive BB 26144, “TER Grand Est” livery, ep. VI

**Points forts du nouveau modèle Jouef**

- Nouvelle face avant de la locomotive avec essuie-glaces rapportés séparément (pièces photodécoupées en acier inoxydable)
- Bogies nouvellement modélisés
- Nouvel aménagement intérieur avec une figurine de conducteur de locomotive qui salue
- Eclairage intérieur des cabines de conduite commutable en mode numérique
- Pantographes entièrement fabriqués en métal et conformes à l'original, différents pour la BB 26144





# Les CC 6500



Photo: Renaud Cornu-Emieux 



Photo: Renaud Cornu-Emieux 

## Les CC 6500.

La SNCF Classe CC 6500 est un type de locomotives électriques 1,5 kV DC. La CC 6500 était, avec la CC 40100 et la CC 72000 diesel, la première génération de la famille de locomotives «Nez Cassé» et conçue pour tracter des trains express à des vitesses allant jusqu'à 200 km / h (124 mph) mais aussi utilisé pour les trains de marchandises lourds. Parmi les trains qu'ils ont transportés au cours de leurs premières années de service figuraient le train phare de la SNCF Le Mistral et les trains Trans Europ Express Aquitaine, Le Capitole et l'Étendard.

Les locomotives avaient des bogies monomoteurs à 3 essieux avec chaque ensemble de 3 essieux couplés par des engrenages. La régulation de la vitesse était assurée par des rhéostats et une commande série-parallèle. Les moteurs avaient des armatures doubles, il y avait donc quatre «demi-moteurs» qui permettaient trois groupements de moteurs: série

complète, série-parallèle et parallèle complet. Le contrôleur de puissance avait 28 étapes. Le deuxième lot de locomotives CC 6500 était équipé de capteurs électriques à troisième rail destinés à être utilisés sur la ligne à forte déclivité de la Maurienne dans les Alpes, qui ont été retirés lorsque la ligne a été convertie en alimentation caténaire aérienne.

Entre 1969 et 1976, un total de 74 locomotives ont été construites, la dernière de cette classe ayant été mise hors service en 2007. Quatre autres ont été construites en tant que locomotives à double système 1,5 kV DC / 25 kV AC et désignées Classe CC 21000. Celles-ci ont été reconfigurées, pour une utilisation comme locomotives à courant continu uniquement entre 1995 et 1996, portant le total des locomotives CC 6500 à 78.



**SNCF, locomotive électrique CC 6526 « Le Capitole », ép. IV - coffret anniversaire**

SNCF, Elektrolokomotive CC 6526 „Le Capitole“, Epoche IV – Jouef-Jubiläumsartikel

SNCF, locomotiva elettrica CC 6526 “Le Capitole”, ep. IV - cofanetto anniversario

SNCF, locomotora eléctrica CC 6526, decoración “Le Capitole”, ép. IV – set de aniversario

SNCF, electric locomotive CC 6526 “Le Capitole”, ep. IV – Jouef Anniversary item

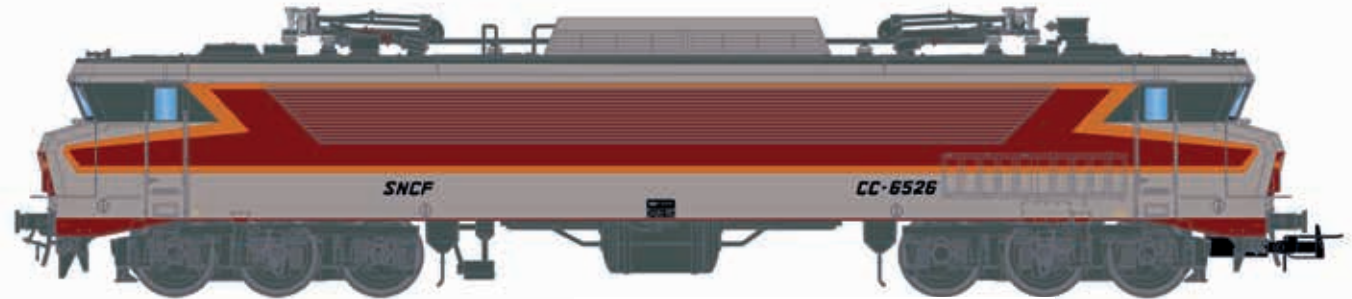
**Modèle spécial du 80e anniversaire de Jouef dans un emballage commémoratif**

© Jacques-Henri Renaud, (coll. Loco-Revue)

**Le Capitole**

Le 15 novembre 1960, la SNCF met en circulation pour la première fois un train baptisé le Capitole entre Paris et Toulouse. Nommé en référence au célèbre édifice toulousain, le train circule en fin de soirée trois fois par semaine (sauf les samedis et dimanches) et vise avant tout la clientèle d'affaires. Il effectue les 713 km du parcours de Paris-Austerlitz à Toulouse-Matabiau en sept heures avec quatre arrêts intermédiaires à Limoges, Brive-la-Gaillarde, Cahors et Montauban.

Au début, le Capitole n'est composé que de quatre ou cinq voitures de 1re classe DEV Inox, une voiture restaurant de la CIWL et un fourgon. La baisse d'activité pendant l'été conduit même la SNCF à interrompre sa circulation en juillet et août 1961. Cependant, le service gagne progressivement en popularité, surtout en fin de semaine, et un deuxième service du soir est mis en place les vendredis, d'abord entre Paris et Limoges puis jusqu'à Brive-la-Gaillarde. En 1962, le temps de parcours est abaissé à 6 h 45.

Le 28 mai 1967, le Capitole est le premier train en France à rouler à 200 km/h en service commercial entre Fleury-les-Aubrais et Vierzon et à vitesse plus réduite sur le tronçon Limoges - Caussade où la vitesse limite est normalement de 120 km/h. La durée du trajet est ainsi abaissée à 6 h exactement, avec départ peu avant 18 h et arrivée au terminus quelques minutes avant minuit, ce qui s'avère plus rapide que l'Intercités actuel qui met 6 h 30 pour faire le même trajet mais avec davantage d'arrêts et une charge plus élevée. Le succès commercial est immédiat et le 29 septembre 1968 la SNCF met en service un Capitole du matin en complément de celui du soir. En 1970 apparaissent les nouvelles locomotives CC 6500, assorties aux voitures Grand Confort. Initialement mises en service sur L'Étendard Paris - Bordeaux, ces voitures climatisées remplacent les UIC sur le Capitole à mesure des livraisons et assurent un service de grande qualité.

# Les CC 21000



Photo: J. Planglet 

## ... les CC 6500 polycourant

En 1969, deux locomotives furent mises en service, la CC 21001 le 17 juin et la CC 21002 le 2 juillet 1969. Plus tard, elles furent rejointes par les machines CC 21003 et CC 21004 mises en service les 30 juin et 29 juillet 1974. Les locomotives furent utilisées dans différents tests liés au futur TGV. Sur celles-ci, la CC 21001 a atteint une vitesse de 285 km/h en 1975, établissant un record mondial avec un courant alternatif de 25 kV et 50 Hz.

Deux locomotives ont été adaptées pour circuler sur la nouvelle ligne à grande vitesse entre Paris et Lyon et elles ont permis de mesurer la géométrie de la voie, de localiser et de mesurer les défauts et déformations du rail avec le wagon Mauzin. Les machines CC 21003 et CC 21004 ont été mises en service sur le TEE 22/23 "Cisalpin" (Paris-Gare de Lyon - Milano Centrale - Venezia Santa Lucia), qui circulait sur la partie française de son itinéraire sur le tronçon Paris - Vallorbe sous courant 1,5 kV DC et 25 kV 50 Hz AC.

A noter que la CC 21003 a mené une campagne d'essais aux Etats Unis en 1977 pour la compagnie AMTRAK: elle était profondément modifiée, avec une livrée gris métal, des attelages automatiques, et une alimentation exclusivement en 11000V 25 Hz (du une certaine parenté avec le projet jamais réalisé de 14500. Les essais s'étant révélés très mitigés, aucune commande n'a eu lieu, des machines BB de conception suédois étant préférées. Vu leur faible utilisation, durant les années 80 et 90 les 21001 et 2 ont participé à de nombreux essais sur les lignes TGV et ont permis la mise au point du système de signalisation embarquée (TVM) et de pantographes.

La mise en service des rames TGV tricourant en 1984 provoque la suppression des trains tractés par les CC 21000, qui se retrouvent alors confinées à des trains de marchandises et d'essais divers. L'arrivée des BB 26000 à partir de 1988 aggrave encore leur situation, si bien que la série n'est plus utilisée régulièrement, et que sa radiation est évoquée.

Une autre possibilité envisagée est l'uniformisation des circuits des quatre engins (vu leur statut de quasi prototypes, toutes avaient de profondes différences) et de les utiliser en service marchandises en Rhône Alpes sur des lignes électrifiées en 25000 V où ne peuvent circuler les CC 6500 (principalement Lyon - Grenoble / Chambéry, voire Bellegarde - Evian).

Entre octobre 1995 et février 1997, toute la série CC 21000 a été reconstruite en tant que locomotives à courant continu à système unique pour 1,5 kV CC. Après conversion, ils furent affectés à la série CC 6500 sous les noms CC 6575, CC 6576, CC 6577 et CC 6578 et affectés au dépôt de Vénissieux. Tous ont été mis hors service en 2007.

La machine qui est restée en activité le plus longtemps était la CC 6575 (ex CC 21001), qui a été prêtée à l'association Sauvons la CC 6575 pendant 10 ans et qui est aujourd'hui de nouveau sous le nom de CC 21001.





HJ2454/HJ2454S



SNCF

NEW

**SNCF, locomotive bi-courant CC 21001, livrée Grand Confort avec logo nouille, ép. IV**

SNCF, Mehrsystem-Elektrolokomotive CC 21001 in Grand-Confort-Farbgebung mit "Nudellogo", Epoche IV

SNCF, locomotiva bicorrente CC 21001, livrea Grand Confort con logo "Nouille", ep. IV

SNCF, locomotora multisistema CC 21001, decoración "Grand Confort" con logo "Nouille", ép. IV

SNCF, multi-system locomotive CC 21001 in Grand Confort livery with logo nouille, ep. IV



Fotomontage / Fotomontaje / Photomontage / Fotomontaggio



HJ2453/HJ2453S



SNCF

NEW

**SNCF, locomotive électrique CC 6504 « Vitry-sur-Seine » en livrée « FRET », ép. V**

SNCF, Elektrolokomotive CC 6504 „Vitry-sur-Seine“ in grüner „FRET“-Farbgebung, Ep. V

SNCF, locomotiva elettrica CC 6504 "Vitry-sur-Seine", livrea "FRET", ep. V

SNCF, locomotora eléctrica CC 6504 "Vitry-sur-Seine", decoración verde "FRET", ép. V

SNCF, electric locomotive CC 6504 "Vitry-sur-Seine" in green "FRET" livery, ep. V



**La CC 406504 FRET**

- Nouvelle face avant de la locomotive avec logo SNCF rectangulaire
- Pantographes entièrement fabriqués en métal et conformes à l'original





HJ2458/HJ2458S



SNCF

NEW

**SNCF, locomotive électrique tritension « Astride » BB 36031, blasons « Bons-en-Chablais / Castione », livrée fret , ép. V**

SNCF, Zweisystem-Elektrolokomotive „Astride“ BB 36031 „Bons-en-Chablais / Castione“ in grün-silberner Farbgebung, Ep. V

SNCF, locomotiva elettrica tritensione "Astride" BB 36031, stemma "Bons-en-Chablais / Castione", livrea verde, ep. V

SNCF, locomotora eléctrica dual-system "Astride" BB 36031, "Bons-en-Chablais / Castione", decoración verde y plata, ép. V

SNCF, dual-system electric locomotive "Astride" BB 36031 "Bons-en-Chablais / Castione", green livery, ep. V



Fotomontage / Fotomontaje / Photomontage / Fotomontaggio



HJ2459/HJ2459S



SNCF

NEW

**SNCF, locomotive électrique tritension « Astride » BB 36008 blasons « Blainville/Damelevières », livrée multiservice, ép. VI**

SNCF, Zweisystem-Elektrolokomotive „Astride“ BB 36008 „Blainville/Damelevières“ in rot-silberner Farbgebung, Ep. VI

SNCF, locomotiva elettrica tritensione "Astride" BB 36008 con stemma "Blainville/Damelevières", livrea "Multiservice", ep. VI

SNCF, locomotora eléctrica BB 36008, "Blainville/Damelevières", decoración rojo, ép. VI

SNCF, dual-system electric locomotive "Astride" BB 36008 "Blainville/Damelevières", red livery, ep. VI



Fotomontage / Fotomontaje / Photomontage / Fotomontaggio





**Akiem, locomotive électrique tritension « Astride » BB 36011, nouvelle livrée Akiem, ép. VI**

Akiem, Zweisystem-Elektrolokomotive „Astride“ BB 36011 in neuer Akiem-Farbgebung, Ep. VI

Akiem, locomotiva elettrica tritensione “Astride” BB 36011, nuova livrea Akiem, ep. VI

Akiem, locomotora eléctrica BB 36011 “Astride”, decoración Akiem nueva, ép. VI

Akiem, dual-system electric locomotive “Astride” BB 36011, new Akiem livery, ep. VI



Fotomontage / Fotomontaje / Photomontage / Fotomontaggio



Photo: Akiem

**Les BB 36000 « Astride »**

Basée sur la plate-forme Astride, cette locomotive est conçue pour tirer des trains de marchandises et de passagers. Sa forte puissance de traction et sa capacité à tirer des trains de plus de 2 000 tonnes en font l'une des locomotives les plus puissantes de la flotte Akiem pour la France ou le Maroc.

Conçues à l'origine pour des trajets directs entre la Belgique et l'Italie, les locomotives numérotées 36001 à 36030 ne sont finalement homologuées que pour les réseaux français et belges. (aujourd'hui elles sont bannies du réseau belge car dépourvues de l'ERTMS), les spécialisant de fait à ces deux zones d'action. Les locomotives anciennement numérotées 36031 à 36060, quant à elles, ont perdu leurs équipements belges afin d'être homologuées pour le réseau italien. Ces 30 locomotives ont été renumérotées en BB 36300 afin de marquer

leur aptitude au réseau RFI. Cette locomotive évite ainsi une rupture de charge lors du passage des frontières, c'est-à-dire un changement de locomotive à cause des différents courants d'alimentation et de la signalisation en particulier, et permet des gains de temps significatifs, en évitant un relais avec des machines italiennes ou belges.

La BB 36000 est équipée de bogies bimoteurs. Techniquement adaptées pour rouler jusqu'à 220km/h maximum, elles n'atteignent cependant pas de telles vitesses dans leurs utilisations actuelles. Les soixante BB 36000 ont été livrées entre 1996 (16 janvier 1996 pour la 36001) et 2002 (29 juin 2002 pour la 36060). Ces locomotives ont un « air de famille » avec les « Sybic » mais avec les angles arrondis et un meilleur aérodynamisme.



HJ2459



HJ6272



HJ6250



HJ6250

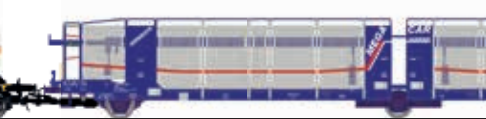

HJ6297



## L'Étoile du Nord

L'Étoile du Nord était un train reliant Paris à Amsterdam via Bruxelles qui circula à partir des années 1920 jusqu'au milieu des années 1990. Ce train, d'abord composé de voitures Pullman de la Compagnie des wagons-lits tracté par des locomotives à vapeur.

L'Étoile du Nord a commencé à circuler entre Paris et Bruxelles pendant les années 1920 et était exploité par les Chemins de Fer du Nord et la SNCB. Lorsqu'en 1927, la Compagnie des wagons-lits reprend l'exploitation de ce train, Amsterdam sera la nouvelle destination<sup>1,2</sup>. En 1957, avec l'arrivée d'un tout nouveau matériel diesel, la ligne de l'Étoile du Nord est étendue jusqu'à Amsterdam et ce train est intégré au pool Trans-Europ-Express. Les premières voitures de voyageurs ont été les luxueuses voitures Pullman de la Compagnie des wagons-lits jusqu'à la fin des années 50.

# ÉTOILE DU NORD

## 1927-1939







HJ4198



CIWL

NEW

**CIWL, coffret de 3 voitures « Etoile du Nord », set 1/2 (1 x DD3, 1 x VP Côte d'Azur et 1 x VPC Étoile du Nord), ép. II**

CIWL, dreiteiliges Set „Etoile du Nord“, Set 1/2 (1 x DD3, 1 x VP Côte d'Azur und 1 x VPC Étoile du Nord), Ep. II

CIWL, set di 3 carrozze “Etoile du Nord”, set 1/2 (1 x DD3, 1 x VP Côte d'Azur e 1 x VPC Étoile du Nord), ep. II

CIWL, primer set de 3 coches “EC Etoile du Nord”, compuesto de un coche DD3, un VP “Côte d'Azur” + un VPC “Étoile du Nord”, ép. II

CIWL, 3-unit pack “Etoile du Nord”, set 1/2 (1 x DD3, 1 x VP Côte d'Azur and 1 x VPC Étoile du Nord), ep. II



Véhicules équipés d'un éclairage intérieur avec commande tactile pour activer et varier l'intensité

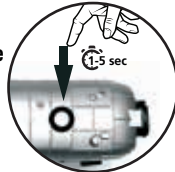

HJ4199



CIWL

NEW

**CIWL, coffret de 3 voitures « Etoile du Nord », set 2/2 (1 x DD3, 1 x VPC Côte d'Azur and 1 x VP Étoile du Nord), ép. II**

CIWL, dreiteiliges Set „Etoile du Nord“, Set 2/2 (1 x DD3, 1 x VPC Côte d'Azur und 1 x VP Étoile du Nord), Ep. II

CIWL, set di 3 carrozze “Etoile du Nord”, set 2/2 (1 x DD3, 1 x VPC Côte d'Azur e 1 x VP Étoile du Nord), ep. II

CIWL, segundo set de 3 coches “EC Etoile du Nord”, compuesto de un coche DD3, un VPC “Côte d'Azur” y un VP “Étoile du Nord”, ép. II

CIWL, 3-unit pack “Etoile du Nord”, set 2/2 (1 x DD3, 1 x VPC Côte d'Azur and 1 x VP Étoile du Nord), ep. II



Véhicules équipés d'un éclairage intérieur avec commande tactile pour activer et varier l'intensité

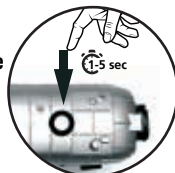





HJ4174



805



SNCF

**NEW****SNCF, coffret de 3 voitures courtes DEV Inox, composé de 1 voiture A8, 1 voiture A3B5 et 1 voiture A5s, ép. III**

SNCF, 3-tlg. Set DEV Inox Reisezugwagen (kurz), bestehend aus 1 x A8, 1 x A3B5 und 1 x A5s, Ep. III

SNCF, set di 3 carrozze DEV Inox corte, composto da 1 carrozza A8, 1 carrozza A3B5 e 1 carrozza A5s, ep. III

SNCF, set de 3 coches tipo DEV Inox cortos, compuesto de un coche A8, un coche A3B5 y un coche A5s, ép. III

SNCF, 3-unit pack of short DEV Inox coaches, including 1 x A8, 1 x A3B5 and 1 x A5s, ep. III

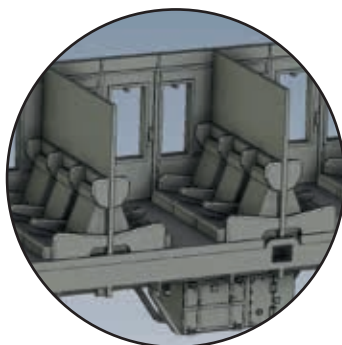

Jeux de roues AC appropriés: HC6102 (10.50 x 24.50 mm)

**Intérieur finement détaillé****Les voitures DEV Inox courtes de JOUEF**

- Nouveaux moules
- Intérieur finement détaillé avec sièges séparés
- Dessous de caisse finement détaillé avec un équipement différent selon l'époque
- Coulisses d'attelage court selon NEM 352 aux deux extrémités des voitures
- Boîtiers NEM 362 pour tête d'attelage interchangeable aux deux extrémités des voitures
- Rayon minimal d'inscription en courbe : 356,5 mm



HJ4175



805



SNCF

NEW

**SNCF, coffret de 3 voitures courtes DEV Inox, composé de 2 voitures B8 et 1 voiture A6D, ép. III**

SNCF, 3-tlg. Set DEV Inox Reisezugwagen (kurz), bestehend aus 2 x B8 und 1 x A6D, Ep. III

SNCF, set di 3 carrozze DEV Inox corte, composto da 2 carrozze B8 e 1 carrozza A6D, ep. III

SNCF, set de 3 coches tipo DEV Inox cortos, compuesto de dos coches B8 y un coche A6D, ép. III

SNCF, 3-unit pack of short DEV Inox coaches, including 2 x B8 and 1 x A6D, ep. III



Jeux de roues AC appropriés: HC6102 (10.50 x 24.50 mm)

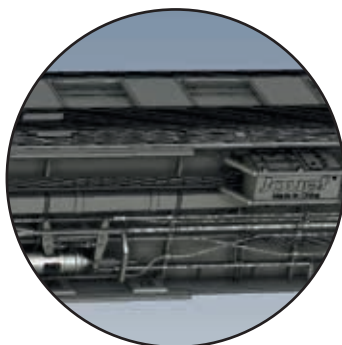

Châssis finement détaillé

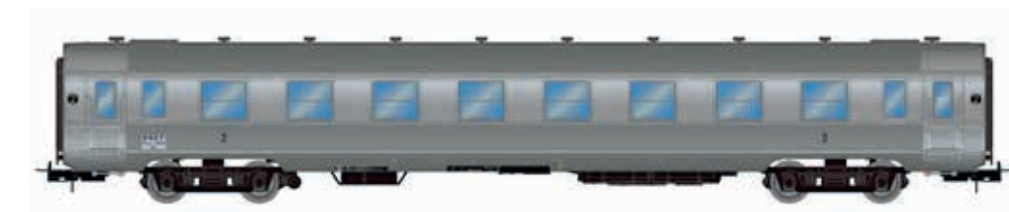



HJ4176

IV-V <sup>537</sup>  
← →

K L

SNCF

**NEW****SNCF, coffret de 2 voitures courtes DEV Inox, avec cartouche Corail, composé de 1 voiture A8 et 1 voiture B6D, ép. IV-V**

SNCF, 2-tlg. Set DEV Inox Reisezugwagen (kurz) mit Corail-Klassennummern, bestehend aus 1 x A8, 1 x B6D, Ep. IV-V

SNCF, set di 2 carrozze DEV Inox corte con pittogrammi di classe Corail, composto da 1 carrozza A8 e 1 carrozza B6D, ep. IV-V

SNCF, set de 2 coches tipo DEV Inox cortos, con números de clase "Corail", compuesto de un coche A8 y un coche B6D, ép. IV-V

SNCF, 2-unit pack of short DEV Inox coaches with Corail class numbers, including 1 x A8 and 1 x B6D, ep. IV-V



Jeux de roues AC appropriés: HC6102 (10.50 x 24.50 mm)



HJ4177

IV-V <sup>537</sup>  
← →

K L

SNCF

**NEW****SNCF, coffret de 2 voitures courtes DEV Inox B8, avec cartouche Corail, ép. IV-V**

SNCF, 2-tlg. Set DEV Inox Reisezugwagen (kurz) B8 mit Corail-Klassennummern, Ep. IV-V

SNCF, set di 2 carrozze DEV Inox corte B8 con pittogrammi di classe Corail, ep. IV-V

SNCF, set de 2 coches tipo DEV Inox cortos, ambos B8 con números de clase "Corail", ép. IV-V

SNCF, 2-unit pack of short DEV Inox coaches B8 with Corail class numbers, ep. IV-V



Jeux de roues AC appropriés: HC6102 (10.50 x 24.50 mm)







HJ4178

VI

876

← →

E

K

SNCF

**SNCF, coffret de 3 voitures, « Train Expo », coffret 1/2, ép. VI**

SNCF, 3-tlg. Set, „Train Expo“, Set 1/2, Ep. VI

SNCF, set di 3 carrozze, “Train Expo”, set 1/2, ep. VI

SNCF, set de 3 coches, “Train Expo”, set 1/2, ép. VI

SNCF, 3-unit pack, “Train Expo”, pack 1/2, period VI

Jeux de roues AC appropriés: HC6105 (10.30 x 23.50 mm)



Fotomontage / Fotomontaje / Photomontage / Fotomontaggio



HJ4179

VI

876

← →

E

SNCF

**SNCF, coffret de 3 voitures, « Train Expo », coffret 2/2, ép. VI**

SNCF, 3-tlg. Set, „Train Expo“, Set 2/2, Ep. VI

SNCF, set di 3 carrozze, “Train Expo”, set 2/2, ep. VI

SNCF, set de 3 coches, “Train Expo”, set 2/2, ép. VI

SNCF, 3-unit pack, “Train Expo”, pack 2/2, period VI

**Les Trains-Expo de la SNCF**

Aujourd'hui, Trains Expo Événements SNCF est la filiale événementielle de la SNCF, spécialisée dans les événements sur rails, à quai ou en voyage. Elle dispose encore d'une rame historique Mistral datant de 1968, en inox. Assurant la liaison Paris-Nice de 1952 à 1981, la rame Mistral est exploitée par la SNCF depuis 1972 pour développer l'activité des Trains Forum devenus en 2000 Trains Exposition puis plus récemment Trains Expo Événements SNCF. Près de 300 Trains Expo ont circulé avec cette rame historique qui a accueilli des expositions diverses et variées.



Jeux de roues AC appropriés: HC6105 (10.30 x 23.50 mm)

Fotomontage / Fotomontaje / Photomontage / Fotomontaggio



HJ4200

VI 876 K L

SNCF

NEW

**SNCF, coffret de 3 voitures Coca-Cola « Train de Noël » de 2010, ép. VI**

SNCF, dreiteiliges Coca-Cola-Weihnachtszugset „Train de Noel“ von 2010, Ep. VI

SNCF, set di 3 carrozze “Treno di Natale” Coca-Cola, 2010, ep. VI

SNCF, set de 3 coches, “Tren de Navidad”, Coca-Cola 2010, ép. VI

SNCF, 3-unit pack Coca-Cola Christmas Train “Train de Noel” from 2010, ep. VI

Jeux de roues AC appropriés: HC6105 (10.30 x 23.50 mm)





HJ4196



SNCF

NEW

**SNCF, coffret de 3 voitures « EC Etoile du Nord » set 1/2 (1 x A4Dtux, 1 x B8u et 1 x B9<sup>1/2</sup>tu), ép. V**

SNCF, dreiteiliges Set EC „Etoile du Nord“, Set 1/2 (1 x A4Dtux, 1 x B8u und 1 x B9<sup>1/2</sup>tu), Ep. V

SNCF, set di 3 carrozze “EC Etoile du Nord”, set 1/2 (1 x A4Dtux, 1 x B8u e 1 x B9<sup>1/2</sup>tu), ep. V

SNCF, primer set de 3 coches “EC Etoile du Nord”, compuesto de un coche A4Dtux, un B8u y un B9<sup>1/2</sup>tu, ép. V

SNCF, 3-unit pack “EC Etoile du Nord” set 1/2 (1 x A4Dtux, 1 x B8u and 1 x B9<sup>1/2</sup>tu), ep. V



Jeux de roues AC appropriés: HC6105 (10.30 x 23.50 mm)



HJ4197



SNCF

NEW

**SNCF, coffret de 3 voitures « EC Etoile du Nord » set 2/2 (1 x Vru, 1 x A3rtu et 1 x A8u), ép. V**

SNCF, dreiteiliges Set EC „Etoile du Nord“, Set 2/2 (1 x Vru, 1 x A3rtu und 1 x A8u), Ep. V

SNCF, set di 3 carrozze “EC Etoile du Nord”, set 2/2 (1 x Vru, 1 x A3rtu e 1 x A8u), ep. V

SNCF, segundo set de 3 coches “EC Etoile du Nord”, compuesto de un coche Vru, un A3rtu y un A8u, ép. V

SNCF, 3-unit pack “EC Etoile du Nord” set 2/2 (1 x Vru, 1 x A3rtu and 1 x A8u), ep. V

Jeux de roues AC appropriés: HC6105 (10.30 x 23.50 mm)







HJ4168

IV

876



L

K

SNCF

**SNCF, coffret de 3 voitures Grand Confort « TEE Le Capitole », composé de 1 voiture A8u, 1 voiture A8tu et 1 voiture A3rtu, ép. IV**

SNCF, 3-tlg Set Grand Confort Reisezugwagen „TEE Le Capitole“, bestehend aus 1 x A8u, 1 x A8tu und 1 x A3rtu, Ep. IV  
SNCF, set di 3 carrozze Grand Confort "TEE Le Capitole", composto da 1 carrozza A8u, 1 carrozza A8tu e 1 carrozza A3rtu, ep. IV  
SNCF, set de 3 coches Grand Confort «TEE Le Capitole», compuesto de 1 coche A8u, 1 coche A8tu y 1 coche A3rtu, ép. IV  
SNCF, 3-unit set of Grand Confort coaches "TEE Le Capitole", including 1 A8u coach, 1 A8tu coach and 1 A3rtu coach, period IV



**Voitures équipées de éclairage intérieur avec commande tactile pour activer et varier l'intensité**



HJ4169

IV

876



L

K

SNCF

**SNCF, coffret de 3 voitures Grand Confort « TEE Le Capitole », composé de 1 voiture A8u, 1 voiture Vru et 1 voiture A4Dtux, ép. IV**

SNCF, 3-tlg Set Grand Confort Reisezugwagen „TEE Le Capitole“, bestehend aus 1 x A8u, 1 x Vru und 1 x A4Dtux, Ep. IV  
SNCF, set di 3 carrozze Grand Confort "TEE Le Capitole", composto da 1 carrozza A8u, 1 carrozza Vru e 1 carrozza A4Dtux, ep. IV  
SNCF, set de 3 coches Grand Confort «TEE Le Capitole», compuesto de 1 coche A8u, 1 coche Vru y 1 coche A4Dtux, ép. IV  
SNCF, 3-unit set of Grand Confort coaches "TEE Le Capitole", including 1 A8u coach, 1 Vru coach and 1 A4Dtux coach, period IV



**Voitures équipées de éclairage intérieur avec commande tactile pour activer et varier l'intensité**





HJ4170



SNCF

**SNCF, voiture supplémentaire Grand Confort A8u, ép. IV**

SNCF, Ergänzungswagen Grand Confort A8u, Ep. IV  
 SNCF, carrozza aggiuntiva Grand Confort A8u, ep. IV  
 SNCF, coche adicional Grand Confort A8u, ép. IV  
 SNCF, additional Grand Confort coach A8u, period IV

**Voitures équipées de éclairage  
 intérieur avec commande tactile  
 pour activer et varier l'intensité**

**Le nouveau système d'éclairage de contact JOUEF**

- L'éclairage intérieur fonctionne déjà sur environ 5 V, sans piles
- Pour l'allumer et l'éteindre, il suffit de toucher le toit à l'une de ses extrémités
- Grand condensateur tampon pour les sections de voie sales ou autres problèmes de contact
- Fonction de mémorisation de l'état de l'éclairage interne (ON/OFF). Cette fonction est utile pour les arrêts d'urgence numériques, l'arrêt d'une section de voie entière ou l'arrêt d'un train dans une gare en mode analogique
- La lumière peut être atténuée pour chaque voiture séparément en touchant simplement le toit pendant plus d'une seconde.
- Sortie d'usine intégrée, sans soudure ni démontage de la voiture



HJ4171



SNCF

**SNCF, voiture supplémentaire Grand Confort A8tu, ép. IV**

SNCF, Ergänzungswagen Grand Confort A8tu, Ep. IV  
 SNCF, carrozza aggiuntiva Grand Confort A8tu, ep. IV  
 SNCF, coche adicional Grand Confort A8tu, ép. IV  
 SNCF, additional Grand Confort coach A8tu, period IV

**Voitures Grand Confort « Capitole »**

Leur livrée rouge, gris métal et bandeau rouge s'harmonise avec celle des locomotives CC 6500 contemporaines. Construites à 103 exemplaires (34 A8tu, 40 A8u, 6 bars A3rtu, 10 restaurants Vru et 13 fourgons A4Dtux), ces voitures de 1re classe circulent en rame homogène. Dès leur sortie d'usine en juillet 1970, elles sont utilisées sur l'« Etendard » (pas encore TEE) Paris-Bordeaux, puis pour le service d'hiver 1970/71 sur les deux

« Capitole » Paris-Toulouse devenus TEE à cette date, en remplacement des voitures YUIC rouges.

A partir de de 1982, l'un des trains « Capitole » comprend des voitures « Grand Confort » transformées en 2<sup>e</sup> classe, devenant ainsi un train 1<sup>re</sup>/2<sup>e</sup> classe et avant de sortir

définitivement du pool TEE le 30 septembre 1984. De 1991 à 1995, ce sont des voitures « Grand Confort » modifiées qui entrent dans la composition des trains « Eurafaires » entre Paris et Toulouse, puis sur le parcours limité de Paris à Brive jusqu'au service d'hiver 1998/99.



HJ2452

HJ4168 - A8tu

HJ4168 - A8u

HJ4168 - Ar3tu



HJ4171 - A8tu

HJ4169 - A8u

HJ4169 - Vru

HJ4169 - A4Dtux



HJ4191



SNCF

**NEW****SNCF, coffret de 3 voitures Grand Confort TEE « Le Kléber » (1 x A8u, 1 x A8tu + 1 x Vru) en livrée « Grand Confort » grise, ép. IV**

SNCF, dreiteiliges Set Gran Confort-Wagen TEE „Le Kléber“ (1 x A8u, 1 x A8tu + 1 x Vru) in grauer „Grand Confort“-Farbgebung, Ep. IV

SNCF, set di 3 carrozze Grand Confort TEE “Le Kléber” (1 x A8u, 1 x A8tu + 1 x Vru) in livrea grigia “Grand Confort”, IV ep.

SNCF, primer set de 3 coches Gran Confort, TEE “Le Kléber”, compuesto de un coche A8u, un A8tu y un Vru, decoración gris “Betón”, ép. IV

SNCF, 3-unit pack Gran Confort coaches TEE “Le Kléber” (1 x A8u, 1 x A8tu + 1 x Vru) in grey “Grand Confort” livery, ep. IV

**Voitures équipées de éclairage intérieur avec commande tactile pour activer et varier l'intensité**

HJ4192



SNCF

**NEW****SNCF, coffret de 3 voitures Grand Confort TEE « Le Kléber » (1 x A8u, 1 x A8tu, 1 x A4Dtux) en livrée « Grand Confort » grise, ép. IV**

SNCF, dreiteiliges Set Gran Confort-Wagen TEE „Le Kléber“ (1 x A8u, 1 x A8tu, 1 x A4Dtux) in grauer „Grand Confort“-Farbgebung, Ep. IV

SNCF, set di 3 carrozze Grand Confort TEE “Le Kléber” (1 x A8u, 1 x A8tu, 1 x A4Dtux) in livrea grigia “Grand Confort”, IV ep.

SNCF, segundo set de 3 coches Gran Confort, TEE “Le Kléber”, compuesto de un coche A8u, un A8tu y un A4Dtux, decoración gris “Betón”, ép. IV

SNCF, 3-unit pack Gran Confort coaches TEE “Le Kléber” (1 x A8u, 1 x A8tu, 1 x A4Dtux) in grey “Grand Confort” livery, ep. IV

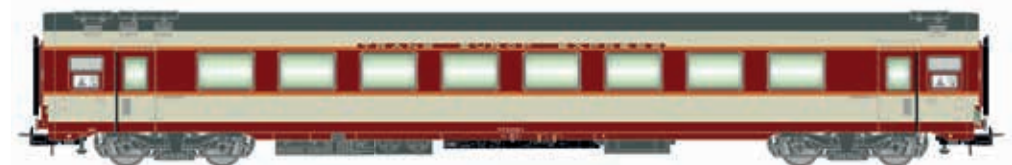
**Voitures équipées de éclairage intérieur avec commande tactile pour activer et varier l'intensité**





HJ4193



SNCF

NEW

**SNCF, voiture supplémentaire Grand Confort A8u pour TEE « Le kléber », livrée « Grand Confort » grise, ép. IV**

SNCF, Gran-Confort-Ergänzungswagen A8u für TEE „Le Kléber“ in grauer „Grand Confort“-Farbgebung, Ep. IV

SNCF, carrozza aggiuntiva Grand Confort A8u per TEE “Le Kléber”, livrea grigia “Grand Confort”, ep. IV

SNCF, coche adicional Gran Confort TEE “Le Kléber”, tipo A8u, decoración gris “Betón”, ép. IV

SNCF, supplementary Gran Confort coach A8u for TEE “Le Kléber” in grey “Grand Confort” livery, ep. IV

**Voitures équipées de éclairage intérieur avec commande tactile pour activer et varier l'intensité**

HJ4194



SNCF

NEW

**SNCF, voiture supplémentaire Grand Confort A8tu pour TEE « Le Kléber », livrée « Grand Confort » grise, ép. IV**

SNCF, Gran-Confort-Ergänzungswagen A8tu für TEE „Le Kléber“ in grauer „Grand Confort“-Farbgebung, Ep. IV

SNCF, carrozza aggiuntiva Grand Confort A8tu per TEE “Le Kléber”, livrea grigia “Grand Confort”, ep. IV

SNCF, coche adicional Gran Confort TEE “Le Kléber”, tipo A8tu, decoración gris “Betón”, ép. IV

SNCF, supplementary Gran Confort coach A8tu for TEE “Le Kléber” in grey “Grand Confort” livery, ep. IV

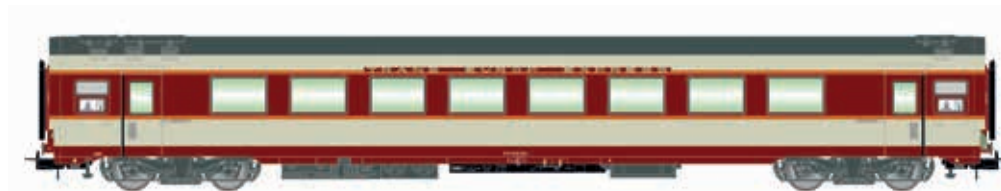
**Voitures équipées de éclairage intérieur avec commande tactile pour activer et varier l'intensité****Le TEE « Kléber »**

Kléber était un train express TEE qui a relié Strasbourg et Paris, en France, entre 1971 et 1988. Le train a été baptisé en l'honneur de Jean Baptiste Kléber, un général français né à Strasbourg pendant les guerres de la Révolution française.

Le Kléber a été mis en service le 23 mai 1971. Le 26 septembre 1982, le service TEE 60 du matin est supprimé. Son nom est transféré au service du soir TEE 62 Strasbourg - Paris, qui était auparavant le TEE Stanislas. Ce dernier devient le Rapide Stanislas, conservant le même horaire de fin de matinée au départ de Paris et reprenant l'horaire matinal de Kléber au départ de Strasbourg.

Le TEE 62, rebaptisé Kléber (ex-TEE Stanislas), continue de partir de Strasbourg à 17h10 et d'arriver à Paris à 21h00. Les TEE 62 / TEE 61 ont cessé d'exister en tant que trains séparés en 1988, lorsqu'ils ont été intégrés dans un train international entre Paris et Stuttgart Hbf à Stuttgart, en Allemagne.



HJ4187

IV  K

SNCF

**SNCF, fourgon porte-autos DD DEV 66, livrée verte avec logo « Encadré » jaune, ép. IV**

SNCF, Autotransportwagen DD DEV 66 in grüner Farbgebung mit gelbem „Encadré“-Logo, Ep. IV  
 SNCF, carro DD DEV 66 per trasporto auto al seguito, livrea verde con logo "Encadré" giallo, ep. IV  
 SNCF, vagón portacoches tipo DD DEV 66, decoración verde con logo "Encadré" amarillo, ép. IV  
 SNCF, car transporter DD DEV 66, green livery with yellow logo "Encadré", ep. IV

**Les DD DEV 66 de la SNCF**

À partir des années 1960, les services de transport ferroviaire ont commencé à être utilisés massivement dans toute l'Europe. Les trains de nuit ou les rapides de jour ont vu l'ajout de wagons à plate-forme à leur composition pour le transport de véhicules de passagers. Ainsi, de longues distances pourraient être couvertes par le train sans avoir à conduire un long trajet routier.

Les wagons à bogies et à deux étages ont été construits au début des années 1960 pour différents réseaux européens. Ces wagons pouvaient transporter 12 véhicules, six à chaque étage. Des installations de deux étages dans les terminaux ferroviaires étaient nécessaires pour le chargement. Les bogies et leurs systèmes de freinage et de roulement ont permis à ces véhicules de rouler couplés dans des trains de passagers rapides, sans limiter leur vitesse maximale. L'avènement de la grande vitesse et la suppression des trains de nuit dans toute l'Europe ont entraîné le déclin et la fin des services fournis avec ce type de véhicule.



HJ4188

V  K

SNCF

**SNCF, fourgon porte-autos DD DEV 66, livrée verte avec logo « Casquette » blanc, ép. V**

SNCF, Autotransportwagen DD DEV 66 in grüner Farbgebung mit weißem „Casquette“-Logo, Ep. V  
 SNCF, carro DD DEV 66 per trasporto auto al seguito, livrea verde con logo "Casquette" bianco, ep. V  
 SNCF, vagón portacoches tipo DD DEV 66, decoración verde con logo "Casquette" blanco, ép. V  
 SNCF, car transporter DD DEV 66, green livery with white logo "Casquette", ep. V

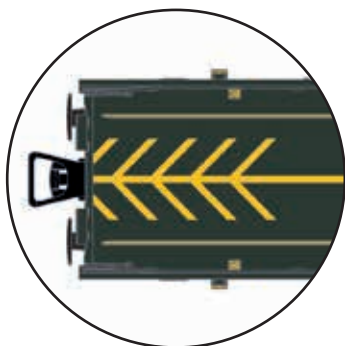



HJ4189

VI

303

K

SNCF

**SNCF, fourgon porte-autos DD DEV 66, 2ème série, livrée verte avec logo « Carmillon » blanc, ép. VI**

SNCF, Autotransportwagen DD DEV 66 der 2. Bauserie in grüner Farbgebung mit weißem „Carmillon“-Logo, Ep. VI

SNCF, carro DD DEV 66 per trasporto auto al seguito, 2a serie, livrea verde con logo "Carmillon" bianco, ep. VI

SNCF, vagón portacoche tipo DD DEV 66, segunda subserie, decoración verde con logo "Carmillon", ép. VI

SNCF, car transporter DD DEV 66, 2nd series, green livery with white logo "Carmillon", ep. VI



Bogie type Y-30



HJ4190

IV-V

606

K

SNCB

**SNCB, coffret de 2 unités, fourgon porte-autos DD DEV 66, livrée bleue, ép. IV-V**

SNCB, 2-tlg. Set, Autotransportwagen DD DEV 66 in blauer Farbgebung, Ep. IV-V

SNCB, set di 2 carri DD DEV 66 per trasporto auto al seguito, livrea blu, ep. V

SNCB, set de 2 wagones portacoche tipo DD DEV 66, decoración azul, ép. IV-V

SNCB, 2-unit pack, car transporter DD DEV 66, blue livery, periov IV-V



Bogie type Schlieren









HJ6292

121  
← → K

SNCF

**NEW**

**SNCF, wagon couvert à 2 essieux, 80<sup>ème</sup> anniversaire JOUEF**

SNCF, zweiachsiger gedeckter Güterwagen, Jubiläumswagen „80 Jahre JOUEF“

SNCF, carro coperto a 2 assi, JOUEF “80<sup>o</sup> anniversario”

SNCF, vagón cerrado de 2 ejes tipo K4, especial “Aniversario JOUEF”

SNCF, 2-axle covered wagon, JOUEF “80th anniversary”

Jeux de roues AC appropriés: HC6101 (11.27 x 24.25 mm)



**JOUEF – 80 ans de modélisme ferroviaire**

Célébrez les 80 ans de passion ferroviaire avec le wagon de marchandises exclusif Jouef. Témoin d'une histoire riche et d'une qualité inégalée, ce wagon commémore cet événement. Offrez-vous ce joyau collector pour enrichir votre collection et continuer l'héritage ferroviaire de Jouef. Un hommage authentique à 80 années d'excellence dans l'univers passionnant des modèles réduits de trains.



Fotomontage / Fotomontaje / Photomontage / Fotomontaggio



HJ6293

VI 480  
← → K

SNCF

**NEW**

**SNCF, coffret de 3 wagons tombereaux type Eamnos, ép. VI**

SNCF, dreiteiliges Set offener GüterWagen der Bauart Eamnos, Ep. VI

SNCF, set di 3 carri a sponde alte tipo Eamnos, ep. VI

SNCF, set de 3 vagones abiertos tipo Eamnos, ép. VI

SNCF, 3-unit pack open wagons type Eamnos, ep. VI

Jeux de roues AC appropriés: HC6101 (11.27 x 24.25 mm)





HJ6255

VI

227

K

F-ERSA

**F-ERSA, wagon plateforme à 4 essieux Rs, « Ermewa », ép. VI**

F-ERSA, vierachsiger Rungenwagen der Bauart Rs, „Ermewa“, Ep. VI

F-ERSA, carro pianale con stanti a 4 assi Rs, “Ermewa”, ep. VI

F-ERSA, vagón plataforma de 4 ejes con teleros tipo Rs, decoración “Ermewa”, ép. VI

F-ERSA, 4-axle stake wagon Rs, “Ermewa”, ep. VI

Jeux de roues AC appropriés: HC6100 (10.27 x 25,20 mm)



Fotomontage / Fotomontaje / Photomontage / Fotomontaggio



HJ6258

IV

227

K

SNCF

**SNCF, wagon plateforme à 4 essieux Res, « Unimetal », ép. IV**

SNCF, vierachsiger Rungenwagen der Bauart Res, „Unimetal“, Ep. IV

SNCF, carro pianale con stanti a 4 assi Res, “Unimetal”, ep. IV

SNCF, vagón plataforma de 4 ejes con teleros tipo Res, decoración “Unimetal”, ép. IV

SNCF, 4-axle stake wagon Res, “Unimetal”, ep. IV

Jeux de roues AC appropriés: HC6100 (10.27 x 25,20 mm)

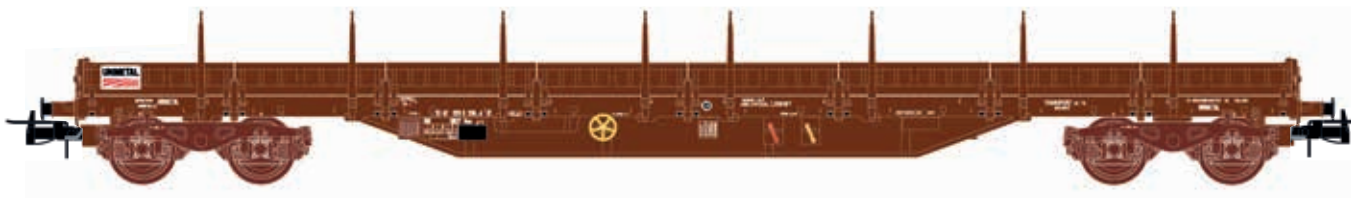





HJ6272

VI

267

K

F-ERSA

**F-ERSA, wagon à parois coulissantes à 4 essieux Habbiss, livrée grise/marron, « Ermewa », ép. VI**

F-ERSA, 4-achs. Schiebewandwagen Habbiss in grau/brauner Lackierung „Ermewa“, Ep. VI

F-ERSA, carro a pareti scorrevoli a 4 assi Habbiss, livrea grigia/marrone, "Ermewa", ep. VI

F-ERSA, vagón de paredes correzidas de 4 ejes Habbiss, decoración gris/marrón, «Ermewa», ép. VI

F-ERSA, 4-axle sliding walls wagon Habbiss, grey/brown livery, "Ermewa", period VI

Jeux de roues AC appropriés: HC6100 (10.27 x 25,20 mm)



HJ6273

V

267

K

SNCF

**SNCF, wagon à parois coulissantes à 4 essieux Habbiss, livrée grise/verte, « FRET », ép. V**

SNCF, 4-achs. Schiebewandwagen Habbiss in grau/grüner Lackierung „FRET“, Ep. V

SNCF, carro a pareti scorrevoli a 4 assi Habbiss, livrea grigia/verde, "FRET", ep. V

SNCF, vagón de paredes correzidas de 4 ejes Habbiss, decoración gris/verde, «FRET», ép. V

SNCF, 4-axle sliding walls wagon Habbiss, grey/green livery, "FRET", period V

Jeux de roues AC appropriés: HC6100 (10.27 x 25,20 mm)





HJ6289

IV 240 € K

SNCF

**NEW**

**SNCF, coffret de 2 wagons gaziers à 2 essieux, « AGA Progas », ép. IV**

SNCF, zweiteiliges Set zweiachsiger Gaskesselwagen „AGA Progas“, Ep. IV

SNCF, set di 2 carri a gas a 2 assi, “AGA Progas”, ep. IV

SNCF, set de 2 vagonos cisterna de 2 ejes para gas, decoración “AGA Progas”, ép. IV

SNCF, 2-unit pack gas tank wagons “AGA Progas”, ep. IV



Jeux de roues AC appropriés: HC6101 (11.27 x 24.25 mm)

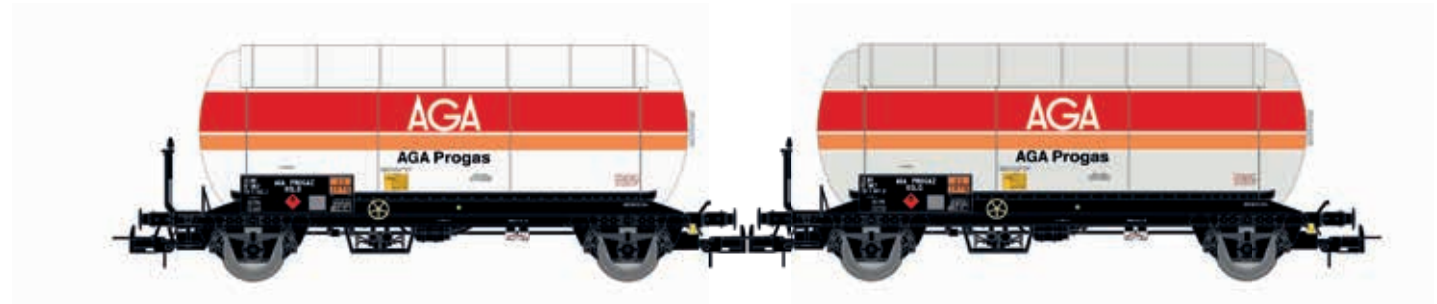

HJ6287

IV 240 € K

SNCF

**NEW**

**SNCF, coffret de 2 wagons gaziers à 2 essieux avec toit pare soleil, « Air Liquide », ép. IV**

SNCF, zweiteiliges Set zweiachsiger Gaskesselwagen mit Sonnenschutzdächern, „Air Liquide“, Ep. IV

SNCF, set di 2 carri cisterna a 2 assi per trasporto gas con tettuccio parasole, “Air Liquide”, ep. IV

SNCF, set de 2 vagonos cisterna de 2 ejes para gas, con protector de techo, decoración “Air Liquide”, ép. IV

SNCF, 2-unit pack of 2-axle gas tank wagons with sun roof, “Air Liquide”, ep. IV



Jeux de roues AC appropriés: HC6101 (11.27 x 24.25 mm)





HJ6264

III 242 K

SNCF

**SNCF, coffret de 2 wagons-citerne à 2 essieux à gaz, « Primagaz », ép. III**

SNCF, 2-tlg. Set 2-achs. Gaskesselwagen, „Primagaz“, Ep. III

SNCF, set di 2 carri a 2 assi per trasporto gas, “Primagaz”, ep. III

SNCF, set de 2 vagonas cisternas para gas de 2 ejes, «Primagaz», ép. III

SNCF, 2-unit set of 2-axle gas tank wagons, “Primagaz”, period III



Jeux de roues AC appropriés: HC6101 (11.27 x 24.25 mm)



HJ6265

IV 242 K

SNCF

**SNCF, coffret de 2 wagons-citerne à 2 essieux à gaz avec toit de protection solaire, « Simotra », ép. IV**

SNCF, 2-tlg. Set 2-achs. Gaskesselwagen mit Sonnenschutzdach, „Simotra“, Ep. IV

SNCF, set di 2 carri cisterna a 2 assi per trasporto gas con tettuccio parasole, “Simotra”, ep. V

SNCF, set de 2 vagonas cisterna para gas de 2 ejes, con techo de protección solar, «Simotra», ép. IV

SNCF, 2-unit set of 2-axle gas tank wagons with sun roof, “Simotra”, period IV



Jeux de roues AC appropriés: HC6101 (11.27 x 24.25 mm)







HJ6250

VI

322

K

SNCF

**NEW****Coffret de 2 wagons-citernes pour le transport de chlore, VTG + Ermewa, livrée beige/orange/rouge, ép. VI**

2-tlg. Set Kesselwagen für den Transport von Chlor, VTG + Ermewa, beige-orange-rote Farbgebung, Ep. VI

Set di 2 carri cisterna per il trasporto di cloro, VTG + Ermewa, livrea beige/arancio/rosso, ep. VI

Set de dos vagones cisternas de cloro, VTG y Ermewa, decoración beige/naranja/rojo, ép. VI

2-unit pack tank wagons for the transport of chlorine, VTG + Ermewa, beige/orange/red livery, ep. VI

Jeux de roues AC appropriés: HC6102 (10.50 x 24.50 mm)



HJ6247

IV

246

K

SNCF

**SNCF, coffret de 2 wagons-citerne à 3 essieux, « BP », ép. IV**

SNCF, 2-tlg. Set 3-achs. Kesselwagen, „BP“, Ep. IV

SNCF, set d 2 carri cisterna a 3 assi, „BP“, ep. IV

SNCF, set de 2 vagones cisterna de 3 ejes, «BP», ép. IV

SNCF, 2-unit set of 3-axle tank wagons, “BP”, period IV

Jeux de roues AC appropriés: HC6101 (11.27 x 24.25 mm)





HJ6248

IV

246

K

SNCF

**SNCF, coffret de 2 wagons-citerne à 3 essieux, « Europ Rail S.G.M.F. / Bruyere et Eberlet », ép. IV**

SNCF, 2-tlg. Set 3-achs. Kesselwagen, „Europ Rail S.G.M.F. / Bruyere et Eberlet“, Ep. IV

SNCF, set d 2 carri cisterna a 3 assi, “Europ Rail S.G.M.F. / Bruyere et Eberlet”, ep. IV

SNCF, set de 2 vagoes cisterna de 3 ejes, «Europ Rail S.G.M.F. / Bruyere et Eberlet», ép. IV

SNCF, 2-unit set of 3-axle tank wagons, “Europ Rail S.G.M.F. / Bruyere et Eberlet”, period IV

Jeux de roues AC appropriés: HC6101 (11.27 x 24.25 mm)



HJ6249

IV

246

K

SNCF

**SNCF, coffret de 2 wagons-citerne à 3 essieux, « Petroles de L'Ouest », ép. IV**

SNCF, 2-tlg. Set 3-achs. Kesselwagen, „Petroles de L'Ouest“, Ep. IV

SNCF, set d 2 carri cisterna a 3 assi, “Petroles de L'Ouest”, ep. IV

SNCF, set de 2 vagoes cisterna de 3 ejes, «Petroles de L'Ouest», ép. IV

SNCF, 2-unit set of 3-axle tank wagons, “Petroles de L'Ouest”, period IV

Jeux de roues AC appropriés: HC6101 (11.27 x 24.25 mm)



**HJ6228**

VI K

**F-ERSA****NEW****F-ERSA, coffret de 2 wagons-trémies à 4 essieux Taos, livrée marron, « Ermewa/Chemoil », ép. VI**

F-ERSA, 2-tlg. Set vierachs. Schwenkdachwagen Taos, in brauner Farbgebung, „Ermewa/Chemoil“, Ep. VI

F-ERSA, set di 2 carri tramoggia a 4 assi Taos, livrea marrone, "Ermewa/Chemoil", ep. VI

F-ERSA, set de 2 vagones tolva tipo Taos (con volante), decoración "Ermewa/Chemoil" marrón, ép. VI

F-ERSA, 2-unit pack of 4-axle hopper wagons Taos, brown livery, "Ermewa/Chemoil", ep. VI



Jeux de roues AC appropriés: HC6100 (10.27 x 25,20 mm)

**Les nouveaux wagons de type Taos de Jouef**

Les wagons à toit pivotant de type Taos ont été achetés en France à partir des années 1970. Jusqu'à aujourd'hui, ils sont principalement utilisés pour le transport de sable de quartz et de chaux. Il existe de nombreux sous-types différents, dont nous avons transposé les plus importants dans le modèle réduit. En raison des changements de propriétaires et de locataires de ces wagons, ces modèles nous offriront au cours des prochaines années d'intéressantes variantes de formes et d'inscriptions.

**HJ6229**

V K

**VTG FRANCE****NEW****VTG FRANCE, coffret de 2 wagons-trémies à 4 essieux Taos, livrée gris, « Simotra », ép. V**

VTG FRANCE, 2-tlg. Set vierachs. Schwenkdachwagen Taos, in grauer Farbgebung, „Simotra“, Ep. V

VTG FRANCE, set di 2 carri tramoggia a 4 assi Taos, livrea grigia, "Simotra", ep. V

VTG FRANCE, set de 2 vagones tolva tipo Taos (con volante), decoración "Simotra" gris, ép. V

VTG FRANCE, 2-unit pack of 4-axle hopper wagons Taos, grey livery, "Simotra", ep. V



Jeux de roues AC appropriés: HC6100 (10.27 x 25,20 mm)

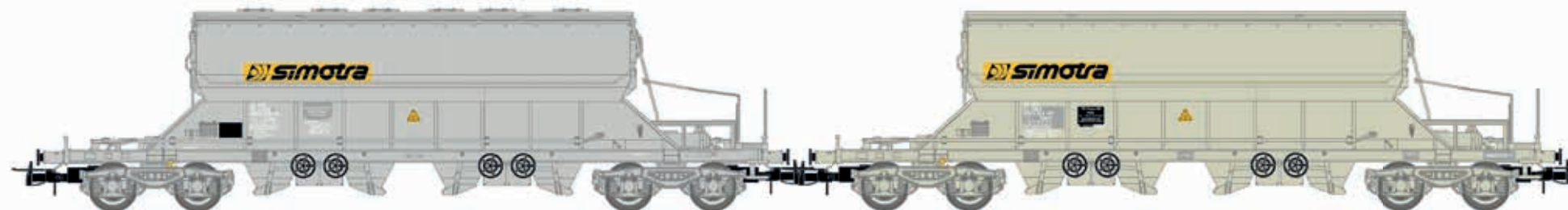





HJ6230

VI  K

NACCO

**NEW**

**NACCO, coffret de 2 wagons-trémies à 4 essieux Taoos, livrée bleue, ép. VI**

NACCO, 2-tlg. Set vierachsiger Schwenkdachwagen Taoos, in hellblauer Farbgebung, Ep. VI

NACCO, set di 2 carri tramoggia a 4 assi Taoos, livrea blu, ep. VI

NACCO, set de 2 wagones tolva de tipo Taoos (con volante), decoración azul, ép. VI

NACCO, 2-unit pack of 4-axle hopper wagons Taoos, light blue livery, ep. VI



Jeux de roues AC appropriés: HC6100 (10.27 x 25,20 mm)



HJ6280

IV  K

SNCF

**NEW**

**SNCF, coffret de 2 wagons trémies à 4 essieux pour le trafic vers l'Espagne, « Transfesa-France » et « SATI », ép. IV**

SNCF, zweiteiliges Set vierachsiger Getreidesilowagen für den Verkehr nach Spanien, „Transfesa-France“ und „SATI“, Ep. IV

SNCF, set di 2 carri tramoggia a 4 assi per il traffico verso la Spagna, “Transfesa-France” e “SATI”, ep. IV

SNCF, set de dos wagones tolva de cereales de paredes redondas, aptas para el tráfico por España, decoraciones “Transfesa-France” y “SATI”, ép. IV

SNCF, 2-unit pack 4-axle cereal hopper wagons for traffic to Spain, “Transfesa-France” and “SATI”, ep. IV

Jeux de roues AC appropriés: HC6100 (10.27 x 25,20 mm)





HJ6281

IV

342

K

SNCF

**NEW****SNCF, coffret de 2 wagons trémies à 4 essieux avec parois planes, « UFAC », ép. IV**

SNCF, zweiteiliges Set vierachsiger Getreidesilowagen mit geraden Seitenwänden, „UFAC“, Ep. IV

SNCF, set di 2 carri tramoggia a 4 assi con pareti piatte, "UFAC", ep. IV

SNCF, set de dos wagones tolva de cereales de paredes planas, decoración "UFAC", ép. IV

SNCF, 2-unit pack 4-axle cereal hopper wagons with flat walls, "UFAC", ep. IV

Jeux de roues AC appropriés: HC6100 (10.27 x 25,20 mm)



HJ6282

VI

171

K

F-MISA

**NEW****F-MISA, wagon trémie à 4 essieux avec parois bombées « Millet » avec graffiti « Telefoot », ép. VI**

F-MISA, vierachsiger Getreidesilowagen mit runden Wänden, „Millet“ mit Graffiti „Telefoot“, Ep. VI

F-MISA, carro tramoggia a 4 assi con pareti curve "Millet" con graffiti "Telefoot", ep. VI

F-MISA, vagon tolva de cereales de paredes planas, decoración "Millet" con graffiti "Telefoot", ép. VI

F-MISA, 4-axle cereal hopper wagon with rounded walls "Millet" with graffiti "Telefoot", ep. VI

Jeux de roues AC appropriés: HC6100 (10.27 x 25,20 mm)





HJ6269

IV

342

K

SNCF

**SNCF, coffret de 2 wagons trémies à 4 essieux avec parois rondes et planes pour le transport de céréales, livrée grise/jaune, « Transcéréales S.H.G.T. Roquette », ép. IV**

SNCF, 2-tlg. Set 4-achs. Schwenkdachwagen für den Getreidetransport, ein Wagen mit gewölbten und einer mit flachen Silowänden, in grau/gelber Lackierung, „Transcéréales S.H.G.T. Roquette“, Ep. IV

SNCF, set di 2 carri tramoggia a 4 assi per il trasporto di cereali a pareti piatte e tonde, livrea grigia/gialla, “Transcéréales S.H.G.T. Roquette”, ep. IV

SNCF, set de 2 wagones tolva de 4 ejes con paredes redondas y planas para cereales, decoración gris/amarillo, «Transcéréales S.H.G.T. Roquette», ép. IV

SNCF, 2-unit set of 4-axle hopper wagons with flat and rounded walls for cereal transport, grey/yellow livery, “Transcéréales S.H.G.T. Roquette”, period IV

Jeux de roues AC appropriés: HC6100 (10.27 x 25,20 mm)



HJ6270

IV

342

K

SNCF

**SNCF, coffret de 2 wagons trémies à 4 essieux pour le transport de céréales vers l'Espagne, « Transcéréales Nacco » et « T.M.F. », ép. IV**

SNCF, 2-tlg. 4-achs. Schwenkdachwagen für den Getreidetransport nach Spanien, „Transcéréales Nacco“ und „TMF“, Ep. IV

SNCF, set di 2 carri tramoggia a 4 assi per il trasporto di cereali per il traffico verso la Spagna, “Transcéréales Nacco” e “TMF”, ep. IV

SNCF, set de 2 wagones tolva de 4 ejes para el transporte de cereales por España, «Transcéréales Nacco» y «TMF», ép. IV

SNCF, 2-unit of 4-axle hopper wagons for cereal transport for traffic to Spain, “Transcéréales Nacco” and “TMF”, period IV

Jeux de roues AC appropriés: HC6100 (10.27 x 25,20 mm)







HJ6271

IV

171

K

SNCF

**SNCF, wagon-trémie à 4 essieux avec parois rondes pour le transport de céréales, « Andros », ép. IV**

SNCF, 4-achs. Schwenkdachwagen mit gewölbten Silowänden für den Getreidetransport, „Andros“, EP. IV

SNCF, carro tramoggia a 4 assi per il trasporto di cereali con pareti tonde, “Andros”, ep. IV

SNCF, vagón tolva de 4 ejes con paredes redondas para cereales «Andros», ép. IV

SNCF, 4-axle hopper wagon with rounded sides for cereal transport, “Andros”, period IV

Jeux de roues AC appropriés: HC6100 (10.27 x 25,20 mm)



HJ6297

VI

304

K

E-TRFSA

**NEW**

**E-TRFSA/Transfesa, wagon porte-autos à 3 essieux Laeks «Mega Car Carrier », livrée argent, ép. VI**

E-TRFSA/Transfesa, dreiachsiger Autotransportwagen der Bauart Laeks „MEGA CAR CARRIER“, silberne Farbgebung, Ep. VI

E-TRFSA/Transfesa, carro trasporto auto a 3 assi tipo Laeks “Mega Car Carrier”, livrea argento, ep. VI

E-TRFSA, vagón portacoche tipo Laeks “Mega Car Carrier”, decoración azul/plata, ép. VI

E-TRFSA/Transfesa, 3-axle car-transporter Laeks “MEGA CAR CARRIER”, silver livery, ep. VI

Jeux de roues AC appropriés: HC6101 (11.27 x 24.25 mm)





HJ6252

IV-V

304  
C →

K

SNCF

**SNCF, wagon bâché à 3 essieux type Lailps, livrée bleue, « Flumroc », ép. IV-V**

SNCF, dreiachsiger Schiebeplanenwagen Lailps in blauer Lackierung, „Flumroc“, Ep. IV-V

SNCF, carro articolato a 3 assi telonato tipo Lailps, livrea blu, “Flumroc”, ep. IV-V

SNCF, vagón articulado entoldado tipo Lailps de 3 ejes, decoración azul, “Flumroc », ép. IV-V

SNCF, 3-axle tarpaulin wagon type Lailps, blue livery, “Flumroc”, ep. IV-V

Jeux de roues AC appropriés: HC6103



HJ6253

IV-V

304  
C →

K

SNCF

**SNCF, wagon bâché à 3 essieux type Lailps, livrée marron/gris, « Citroën », ép. IV-V**

SNCF, dreiachsiger Schiebeplanenwagen Lailps in blauer Farbgebung, „Citroën“, Ep. IV-V

SNCF, carro articolato a 3 assi telonato tipo Lailps, livrea marrone/grigia, “Citroën”, ep. IV-V

SNCF, vagón articulado entoldado tipo Lailps, decoración “Citroën”, ép. IV-V

SNCF, 3-axle tarpaulin wagon Lailps, blue livery, “Citroën”, ep. IV-V

Jeux de roues AC appropriés: HC6103



# Déjà disponible • Schon verfügbar • Già disponibile • Ya disponible • Already Available

**Certains produits annoncés comme encore « en stock » pourraient être déjà épuisés**

*Einige der hier als bereits verfügbar gekennzeichneten Produkte können bereits ab Lager ausverkauft sein.*

*I prodotti qui mostrati come disponibili potrebbero essere già esauriti.*

*Algunos de los productos marcados como ya disponibles podrían estar agotados ya.*

*Some items shown here as still available could already be sold out ex-works.*



**HJ2403**

KPEV, locomotive à vapeur G 8.1, livrée verte/noir, ép. I



**HJ2407**

SNCF, locomotive à vapeur 140 C 362, avec tender 18 C 550, livrée noir/vert à filets jaunes et cercles de chaudière en laiton poli, ép. III



**HJ2415/HJ2415S**

SNCF, locomotive à vapeur 140 C 133, avec tender 18 B 12 (région Est), livrée verte/noire avec bandes rouges, ép. III



**HJ2416/HJ2416S**

SNCF, locomotive à vapeur 140 C 158, avec tender 18 B 521 (région Ouest), livrée noire, ép. III



**HJ2441/HJ2441S**

SNCF, locomotive diesel BB 666442, livrée bleue, ép. VI



**HJ2442/HJ2442S**

SNCF Infra, locomotive diesel BB 466408, livrée verte, ex « FRET », ép. VI



**HJ2386/HJ2386S**

SNCF, autorail à 2 voitures RGP2 classe X2700, livrée verte/jaune, ép. IV



**HJ2387/HJ2387S**

SNCF, autorail à 2 voitures RGP2 classe X2700, livrée RTG inoxydable, ép. IV



**HJ2388/HJ2388S**

SNCF, autorail à 2 voitures RGP2 classe X2700, livrée orange/gris, ép. IV







### HJ2418/HJ2418S

SNCF, autorail à 2 voitures RGP II X 2717 avec remorque XR 7710, livrée vert/beige avec logo d'origine, ép. III



### HJ2419/HJ2419S

SNCF, autorail à 2 voitures RGP II X 2716 avec remorque XR 7719, avec déflecteurs de fumée, livrée vert/beige, ép. III-IV



### HJ2420/HJ2420S

SNCF, autorail à 2 voitures RGP II X 2712 avec remorque XR 7714, avec déflecteurs de fumée, livrée vert/beige, ép. III-IV



### HJ2429/HJ2429S

SNCF, autorail à 2 voitures RGP II X 2719 avec remorque XRAB 7708, avec déflecteurs de fumée, livrée vert/beige, ép. IV



### HJ2400/HJ2400S

SNCF, locomotive électrique BB 12055, livrée original sans "miofilters", ép. III



### HJ2401/HJ2401S

SNCF, locomotive électrique BB 12130, 4ème type avant avec miofilters, livrée vert, ép. IV



### HJ2402/HJ2402S

SNCF, locomotive électrique BB 13020, 2ème type avant, livrée vert, ép. III-IV



### HJ2449/HJ2449S

SNCF, locomotive diesel BB 67210, livrée jaune/blanche, « Infra Structure », ép. V, avec décodeur sonore



### HJ2450/HJ2450S

SNCF, locomotive électrique BB 12013 avec 2 fanaux hautes et 2 fanaux basses, livrée bleu/jaune avec plaques rouges, ép. III, avec décodeur sonore



### HJ2372/HJ2372S

SNCF, locomotive électrique classe CC 6517, livrée "Béton rouge", ép. IV



### HJ2373S

SNCF, locomotive électrique classe CC 21001, livrée original, ép. IV



### HJ2421/HJ2421S

SNCF, locomotive électrique CC 21003, livrée béton, ép. IV





### HJ2423/HJ2423S

SNCF, locomotive électrique CC 14015, avec 2 fanaux, livrée verte, ép. III



### HJ2424/HJ2424S

SNCF, locomotive électrique CC 14018, avec 4 fanaux, livrée verte, ép. III



### HJ2426/HJ2426S

SNCF, locomotive électrique CC 6543 Maurienne, livrée verte, ép. IV



### HJ2427/HJ2427S

SNCF, locomotive électrique CC 6568, livrée béton, ép. IV



### HJ2362ACS

SNCF, TGV Euroduplex AC SOUND



### HJ2412

SNCF, coffret de 4 unités, TGV Sud-Est, livrée orange, ép. IV - "Record du Monde 26 Février 1981, 380 km/h"



### HJ4152

SNCF, set di 3 carrozse RIB 70, livrea d'origine con porte d'accesso rosse, ep. IV-V



### HJ4154

SNCF, coffret de 3 voitures RIO 82 PACA II, ép. V



### HJ4160

SNCB, voiture-lits T2, livrée TEN «Railtour» avec toit bleu, ép. IVb



### HJ4161

SNCB, voiture-lits T2, livrée CIWL avec logo TEN, ép. IV



### HJ4164

SNCF, coffret de 3 voitures «TEE Mistral», composé de 1 voiture A4Dtux, 1 voiture Vru et 1 A8tu, ép. IV



### HJ4165

SNCF, coffret de 3 voitures «TEE Mistral», composé de 1 voiture Arux, 1 voiture A8u et 1 A4Dtux, ép. IV



**HJ4181**

SNCF, coffret de 2 voitures DEV AO de 2ème classe U59 B9 (ex A9), livrée verte/grise avec logo « Encadré », ép. IV

**HJ4184**

SNCF, coffret de 3 voitures RIO 80 Centre, ép. V-VI

**HJ6232**

SNCF, wagon fermé à 2 essieux Gs pour le transport de chevaux, livrée jaune, ép. IV

**HJ6240**

F-NOVA, wagon porte-conteneurs à 4 essieux Sgss, chargé avec un conteneur de 45' «P&O Ferrymasters», ép. VI

**HJ4182**

SNCF, coffret de 2 voitures DEV AO de 2ème classe U59 B9 (ex A9), livrée verte/grise avec logo « Nouille », ép. IV-V

**HJ4185**

SNCF, coffret de 4 voitures RIO 77, « Stelyrail bleu », ép. V-VI

**HJ6238**

SNCF, wagon bâché à 3 essieux Lails, livrée bleue, «Flumroc», ép. IV

**HJ6241**

SNCF, wagon porte-conteneurs à 4 essieux Sgss, chargé avec un conteneur de 45' «Norbert Dentressangle», ép. V-VI

**HJ4183**

SNCF, coffret de 2 unités, train de maintenance, composé de 1 voiture DEV Inox et 1 wagon G4, ép. IV-V

**HJ4186**

SNCF, coffret de 3 voitures RIO 78 TER (ex NPDC), livrée jaune/argent, ép. V

**HJ6239**

SNCF, wagon silo à 2 essieux Ucs, « Fixit », ép. V

**HJ6242**

SNCF, wagon porte-conteneurs à 4 essieux Sgss, chargé avec 2 Container de 20' «Citroën», ép. IV







**HJ6243**

TOUAX, wagon porte-conteneur à 4 essieux Sgss avec caisse mobile «Rail Route», ép. V



**HJ6254**

DB, wagon fermé à 2 essieux G4 avec parois lisses, livrée "Coca Cola", ép. IV



**HJ6259**

SNCF, wagon porte-conteneurs à 4 essieux S70, chargé avec 2 conteneurs porte-bobines de 20' « T.T.S », ép. V



**HJ6260**

SNCF, wagon porte-conteneurs à 4 essieux S70, chargé avec 2 conteneurs porte-bobines de 20' « TIPES », ép. V



**HJ6261**

TOUAX, wagon porte-conteneurs à 4 essieux S7B, chargé avec 2 Coil-containers de 20' « ONE », ép. V



**HJ6262**

Wagon porte-conteneurs à 4 essieux Sgnss, chargé avec un conteneur de 45' « Tab Rail Road », ép. V



**HJ6263**

Wagon porte-conteneurs à 4 essieux Sgnss, chargé avec un conteneur de 45' « Geodis », ép. V



**HJ6267**

BRAMBLES, wagon plat de voitures à 3 essieux Laeks, livrée bleue, ép. IV



**HJ5704**

**JUNIOR LINE**

Flat car with pipes load



**HJ1060**

**JUNIOR LINE**

TGV 2N2 Duplex



**HJ1062**

**JUNIOR LINE**

SNCF Infra Start Set









# INDEX • *Index*

Autorails . . . . .	72
Produits disponibles . . . . .	74

<i>Railcars . . . . .</i>	<i>72</i>
<i>Available Products . . . . .</i>	<i>74</i>



Jouef Loisirs est la gamme de Jouef destinée à un public plus jeune et néophyte. Grâce à la capacité de Jouef Loisirs à s'adapter aux besoins de chacun, vous ne pourrez plus vous en passer.

De nouveaux autorails et d'autres surprises vous attendent, profitez de ce catalogue conçu spécialement pour vous !







**SNCF, autorail diesel X 3800 « Picasso », livrée rouge rubis/gris perle, ép. III**

SNCF, vierachsiger Dieseltriebwagen X 3800 „Picasso“, in dunkelrot-grauer Farbgebung, Ep. III

SNCF, automotrice diesel X 3800 "Picasso", livrea rosso scuro/grigia, ep. III

SNCF, automotor diesel X 3800 "Picasso", decoración rojo oscuro/gris, ép. III

SNCF, diesel railcar X 3800 "Picasso" in dark red/grey livery, ep. III

**Les autorail X 3800 «Picasso»**

La série d'autorails X 3800 constitue l'une des plus importantes séries d'autorails unifiés de la SNCF élaborés par la "Division d'études des autorails de la traction thermique de la SNCF" (DEA) en 1947.

L'autorail X 3800, dit unifié 300 ch et surnommé autorail « Picasso », est une série d'autorails diesel à bogies exploités par la SNCF entre 1950 et 19881. Ces autorails facilement reconnaissables à leur kiosque de conduite latéral surélevé ont été construits à 251 exemplaires, et en plusieurs sous-séries par trois constructeurs différents, à savoir par la Régie Nationale des Usines Renault (RNUR), De Dietrich et les Ateliers de construction du Nord de la France (ANF).

Ils étaient aménagés le plus souvent en deuxième classe, offraient 62 places assises et pouvaient circuler en jumelage et/ou avec une remorque. Ils étaient dotés d'un moteur Renault de type 517 G (d'une puissance unitaire de 300 ch portée par la suite à 340 ch) ou de type 575 (d'une puissance unitaire de 360 ch), ou Saurer de type BZDS (d'une puissance unitaire de 320 ch), ces derniers étant fabriqués sous licence par la Société des Forges et Ateliers du Creusot (SFAC).

Ils sont surnommés « Picasso » à cause de leur cabine de conduite excentrée et dont la forme n'était pas en harmonie avec celle de la caisse, ce qui faisait penser aux tableaux de visages peints par Pablo Picasso où les yeux, le nez étaient complètement décalés1.

La série X 3800 « Picasso » a été remplacée par la famille des Éléments Automoteurs Doubles (EAD). En fin de carrière de rares exemplaires, comme l'X 3828, eurent le toit peint en rouge.

Leur fiabilité, leur rusticité, mais aussi leur ligne si particulière avec le poste de conduite dans le kiosque, sont autant d'atouts qui ont poussé à en conserver : plusieurs exemplaires ont été préservés et sont exploités par des chemins de fer touristiques.



© Jean-Philippe Thernisien



HJ2617



SNCF

**NEW**

**SNCF, autorail diesel X 3800 « Picasso », livrée rouge/beige, ép. III**

SNCF, vierachsiger Dieseltriebwagen X 3800 „Picasso“, in rot-beiger Farbgebung, Ep. III

SNCF, automotrice diesel X 3800 "Picasso", livrea beige/rossa, ep. III

SNCF, automotor diesel X 3800 "Picasso", decoración rojo/beige, ép. III

SNCF, diesel railcar X 3800 "Picasso" in red/beige livery, ep. III



HJ2619



SNCF

**NEW**

**SNCF, autorail diesel X 93953 « Picasso », livrée bleue/beige, ép. IV**

SNCF, vierachsiger Dieseltriebwagen X 93953 „Picasso“, in blau-beiger Farbgebung, Ep. IV

SNCF, automotrice diesel X 93953 "Picasso", livrea blu/beige, ep. IV

SNCF, automotor diesel X 93953 "Picasso", decoración azul/beige, ép. IV

SNCF, diesel railcar X 93953 "Picasso" in blue/beige livery, ep. IV





# Déjà disponible • Schon verfügbar • Già disponibile • Ya disponible • Already Available

## **Certains produits annoncés comme encore « en stock » pourraient être déjà épuisés**

*Einige der hier als bereits verfügbar gekennzeichneten Produkte können bereits ab Lager ausverkauft sein.*

*I prodotti qui mostrati come disponibili potrebbero essere già esauriti.*

*Algunos de los productos marcados como ya disponibles podrían estar agotados ya.*

*Some items shown here as still available could already be sold out ex-works.*



**HJ2603**

SNCF, locomotive diesel CC 72033, livrée bleue avec logo «Nouille», ép. IV-V



**HJ2604**

SNCF, locomotive diesel CC 72068, livrée «Multiservice», ép. V



**HJ2605**

SNCF, locomotive diesel CC 72030, livré «Tricolore», ép. IV



**HJ2613**

SNCF, autorail diesel EAD X 4697 + XR 8694, « Pays de la Loire », ép. V



**HJ2614**

SNCF, autorail diesel EAD X 4317 + XR 8517, livrée rouge/beige, ép. IV



**HJ2615**

SNCF, autorail diesel EAD XBD 4717 + XRABx 8714, livrée argent/bleue avec logo « Casquette », ép. IV-V







Matthieu Letourneau







## MKD2020

### Villa avec garage - Kit

Wohnhaus mit Garage - Bausatz  
Villa con garage - Kit  
Villa con garaje - Kit  
Terraced house with garage - Kit



## MKD2021

### Réparateur de tracteurs - Kit

Landmaschinenwerkstatt - Bausatz  
Officina per macchine agricole - Kit  
Taller de maquinaria agrícola - Kit  
Agricultural machinery workshop - Kit



## MKD2022

### Clôtures de jardin

Gartenzäune  
Recinzioni per giardino  
Vallas de jardín  
Garden Fences



## MKD2023

### BP Station-Service - Kit

Tankstelle - Bausatz  
Stazione di servizio - Kit  
Gasolinera - Kit  
Service Station - Kit



## MKD2024

### Garage Peugeot - Kit

Autohaus Peugeot - Bausatz  
Autosalone Peugeot - Kit  
Concesionario de coches Peugeot - Kit  
Peugeot car dealer - Kit



# Índice • Index

Locomotoras diésel . . . . .	80
Locomotoras eléctricas . . . . .	84
Coches . . . . .	96
Vagones . . . . .	102
Productos disponibles . . . . .	106

<i>Diesel locomotives . . . . .</i>	<i>80</i>
<i>Electric locomotives . . . . .</i>	<i>84</i>
<i>Coaches . . . . .</i>	<i>96</i>
<i>Wagons . . . . .</i>	<i>102</i>
<i>Available Products . . . . .</i>	<i>106</i>

## Electrotren®

El equipo de Electrotren ha puesto todo su empeño y esfuerzo para ofrecer las novedades del catálogo 2024. En él encontrarás una amplia gama de modelos españoles de gran calidad, aptos para todo tipo de aficionados al modelismo ferroviario. Nuestra oferta dispone de una gran variedad locomotoras, automotores, coches y vagones, que sin comprometer la fidelidad son adecuados tanto para usuarios experimentados como para principiantes.

La propuesta para este año incluye novedades de todo tipo de material rodante. En primer lugar, la principal novedad son los electrotrenes de la serie 444 « Revillas », incluyendo la subserie 500 « Lavadoras ». También incluimos el desarrollo de los esperados coches tipo 5000 con testers originales de fuelle, además de la nueva incorporación a la familia de los 8000: los coches literas de 11 departamentos.

Además, ofrecemos nuevas decoraciones de modelos populares como el « Platanito », las locomotoras 269-279, las « Cocodrilos » 7200-7500, los coches postales y restaurantes, los vagones portacoches, las cisternas de gas y mucho más. Por si fuera poco, la gama Electrotren Hobby también se completa con nuevas versiones de los automotores 596 « Tamagotchis ».



[www.electrotren.com](http://www.electrotren.com)







# TIEMPO DE MANIOBRAS



Photo: Mariano Orozco



HE2012/HE2012S



RENFE

NEW

## RENFE, locomotora de maniobras diésel 309, decoración «Estrella», ép IV

RENFE, Diesel-Rangierlokomotive 309 in „Estrella“-Farbgebung, Ep. IV

RENFE, locomotive de manoeuvre diesel 309, livrée « Estrella », ép. IV

RENFE, locomotiva diesel da manovra 309, livrea "Estrella", ep. IV

RENFE, diesel shunting locomotive 309, "Estrella" livery, ep. IV



### Las locomotoras 309

La puesta en servicio de estas locomotoras por parte de Renfe en plena época de los trenes "Estrella" propició que adoptasen esta bonita decoración de origen.





HE2013/HE2013S



RENFE

NEW

**RENFE, locomotora de maniobras diésel 309, decoración «Estrella Cargas RENFE», ép IV-V**

RENFE, Diesel-Rangierlokomotive 309 in „Estrella Cargas RENFE“-Farbgebung, Ep. IV-V  
RENFE, locomotive de manœuvre diesel 309, livrée « Estrella Cargas RENFE », ép. IV-V  
RENFE, locomotiva diesel da manovra 309, livrea "Estrella Cargas RENFE", ep. IV-V  
RENFE, diesel shunting locomotive 309, "Estrella Cargas RENFE" livery, ep. IV-V



Locomotora adscrita a CARGAS RENFE



HE2014/HE2014S



RENFE

NEW

**RENFE, locomotora de maniobras diésel 309, decoración roja/gris, ép IV-V**

RENFE, Diesel-Rangierlokomotive 309 in rot/grauer Farbgebung, Ep. IV-V  
RENFE, locomotive de manœuvre diesel 309, livrée rouge/gris, ép. IV-V  
RENFE, locomotiva diesel da manovra 309, livrea rossa/grigia, ep. IV-V  
RENFE, diesel shunting locomotive 309, red/grey livery, ep. IV-V



Interior detallado con pupitre de conducción iluminado de manera independiente en todas las versiones.







**RENFE, dresina KLV 53, decoración amarillo, ép. IV**

RENFE, Rottenkraftwagen KLV 53 in gelber Farbgebung, Ep. IV

RENFE, draisine KLV 53, livrée jaune, ép. IV

RENFE, draisina KLV 53, livrea gialla, ep. IV

RENFE, maintenance vehicle type KLV 53, yellow livery, ep. IV



Detalles sorprendentes



Llantas y discos de freno en cada rueda



Enganche magnético

**Las KLV**

KLV es el nombre que se les daba a las dresinas en la los ferrocarriles alemanes por parte la DB, (la DR usaba el término SKL).

Las siglas KLV es la abreviatura alemana de "Kleinwagen mit Verbrennungsmotor", que hacen referencia a un pequeño vehículo con motor de combustión. Estas siglas llegaron al ferrocarril español de la mano de los fabricantes alemanes de estos vehículos ligeros autopropulsados destinados a realizar pequeños trabajos de vía, y traslado de materiales y cuadrillas hasta los tajos de vía.





**RENFE, dresina KLV 53, decoración «Mantenimiento de Infraestructura», ép. VI**

RENFE, Rottenkraftwagen KLV 53 in „Mantenimiento de Infraestructura“-Farbgebung, Ep. IV

RENFE, draisine KLV 53, livrée «Mantenimiento de Infraestructura», ép. VI

RENFE, draisina KLV 53, livrea "Mantenimiento de Infraestructura", ep. VI

RENFE, maintenance vehicle type KLV 53, "Mantenimiento de Infraestructura" livery, ep. VI



Escape y detalles en cabina



Luces según modelo y época



Pluma totalmente móvil

**Las KLV de Electrotren**

Los modelos de dresina KLV reproducidos por Electrotren disponen de un alto nivel de acabado y gran detalle.

Según la época y modelo se ha tenido en cuenta detalles como los focos, rejillas y escapes en las cabinas.

Los bajos son detallados y se incluyen los discos y llantas de freno en todas las ruedas.

La pluma puede moverse y se reproducen todos sus elementos.

Los enganches son mediante imán y permiten el paso de corriente eléctrica.

**RENFE, locomotora eléctrica 7501, edición del 80 aniversario, ép. III**

RENFE, schwere Elektrolokomotive der Reihe 7500 der RENFE (Betriebsnr. 7501), Epoche III

RENFE, locomotive électrique 7500 (no. 7501), ép. III, édition 80ème anniversaire

RENFE, locomotiva elettrica classe 7500 (n° 7501), ep. III, edizione 80esimo anniversario

RENFE, heavy electric locomotive class 7500, (no. 7501), ep. III



Fotomontage / Fotomontaje / Photomontage / Fotomontaggio



Modelo conmemorativo del 80 aniversario de la locomotora 7501 en embalaje especial

**Las "Cocodrilo" de RENFE**

Las 12 locomotoras serie 7200 comenzaron a recibirse a finales de 1928 por la Compañía del Norte, siendo asignadas al depósito de Irún, donde fueron reemplazando a las locomotoras de vapor de los trenes más importantes, realizando sus recorridos siempre en las líneas del País Vasco y compartiendo servicios con las 7000 y 7100, sobre todo cuando ambas series fueron desplazadas de Cataluña a Miranda de Ebro desde donde fueron extendiendo su radio de acción a medida que las electrificaciones progresaban, pero no pasaban en general más allá de Burgos, ocupándose de todo tipo de trenes. Tras su paso por el depósito de Irún, su depósito de referencia fue el de Miranda de Ebro donde estuvieron a la cabeza de trenes famosos como el "Surexpreso", el "Costa Vasca" o el "Iberia Expreso".

Las 12 locomotoras de la serie 7500 fueron construidas entre 1944 (7501 y 7502) y 1945 (7503 a 7512) por la Compañía Auxiliar de Ferrocarriles (CAF) a raíz de un pedido efectuado por la casi recién creada RENFE. Las 7500 tenían una potencia de unos 3500 CV, unos 700 más que las 7200 para un peso prácticamente similar y el esfuerzo de tracción de 14600 kg respecto a los 13000 de la primera. Si bien la parte mecánica y el montaje correspondieron a CAF, la eléctrica provenía de las empresas suizas Brown Boveri y Oerlikon y, al igual que las 7200, montaban una transmisión Buchli. Estuvieron asignadas al depósito de Príncipe Pio realizando siempre los mismos servicios y sufriendo muy pocos cambios mecánicos o decorativos.



Photo: Fred Matthews





HE2024/HE2024S



NORTE

**NEW**

**NORTE, locomotora eléctrica 7206, versión Museo Vilanova y la Geltrú, decoración azul/roja**

NORTE, schwere Elektrolokomotive der Reihe 7200, Betriebsnr. 7206 des Eisenbahnmuseums in Villanova y Geltrú in blauer Farbgebung

NORTE, locomotive électrique 7200, immatriculation 7206 du musée ferroviaire de Villanova y Geltrú, livrée bleue

NORTE, locomotiva elettrica pesante classe 7200, numero 7206 del Museo Ferroviario di Villanova y Geltrú in livrea blu

NORTE, heavy electric locomotive class 7200, road no. 7206 of the Railway Museum in Villanova y Geltrú in blue livery



Fotomontage / Fotomontaje / Photomontage / Fotomontaggio



HE2025/HE2025S



RENFE

**NEW**

**RENFE, locomotora eléctrica 272-003 con franja amarilla, ép. IV**

RENFE, schwere Elektrolokomotive der Reihe 272 der RENFE (Betriebsnr. 272 003-5), Epoche IV

RENFE, locomotive électrique 272 (no. 272 003-5), ép. IV

RENFE, locomotiva elettrica pesante classe 272 (numerazione 272 003-5), ep. IV

RENFE series 272 heavy electric locomotive (road number 272 003-5), ep. IV



Fotomontage / Fotomontaje / Photomontage / Fotomontaggio





HE2018/HE2018S



RENFE

**RENFE, locomotora eléctrica clase 279, decoración verde/amarillo, ép. III**

RENFE, Elektrolokomotive Reihe 279 in grün/gelber Farbgebung, Ep. III

RENFE, locomotive électrique classe 279, livrée verte/jaune, ép. III

RENFE, locomotiva elettrica classe 279, livrea verde/gialla, ep. III

RENFE, electric locomotive class 279, green/yellow livery, ep. III



Luces frontales con foco superior independiente



Bajos detallados



Ruedas de radios con rebajes



HE2018

HE4025

HE4025

HE4026

HE4026



**MEDWAY, locomotora eléctrica 269 517-9, decoración negra/amarillo, ép. VI**

MEDWAY, Elektrolokomotive 269 517-9 in schwarz/gelber Farbgebung, Ep. VI

MEDWAY, locomotive électrique 269 517-9, livrée noire/jaune, ép. VI

MEDWAY, locomotiva elettrica 269 517-9, livrea nera/gialla, ep. VI

MEDWAY, electric locomotive 269 517-9, black/yellow livery, ep. VI



Testeros detallados



Bajos detallados



Cabina detallada con maquinista



HE2019

HE6063

HE6063

HE6064

HE6064





# Electrotren 444



## 444 el Electrotren.

A principios de los años 70 Renfe inició una nueva etapa con la aparición de los servicios rápidos con tracción eléctrica prestados con los automotores 432. El éxito de la nueva fórmula y la demanda de ampliación de estos servicios a otros corredores llevó a Renfe a encargarse de una nueva serie de automotores eléctricos.

Los catorce trenes que formaron la serie 444 mejoraron respecto a la serie 432 en confort gracias a su nueva suspensión neumática e insonorización, contando con una mejor fiabilidad y nuevos interiores.

La imagen exterior de los nuevos trenes continuaba con el color rojo de base empleado en los trenes 432 sustituyendo las líneas plateadas por franjas amarillas que otorgaron a los 444 un aspecto único y llamativo entre los demás trenes de Renfe.

La configuración de los trenes 444 estaba formada por un coche motor con cabina de conducción, furgón de paquetería y 72 plazas de segunda clase, un coche intermedio con 88 plazas de segunda clase y un remolque con cabina, cafetería y 52 plazas de primera clase.

Mecánicamente los 444 incorporaban los mismos bogies y motores de tracción que las unidades 440, con una potencia total de 1.160 kW, repartidos entre los cuatro motores del coche motor.

La alimentación de estos trenes era únicamente monotensión a 3 kv, a diferencia de los 432 bitensión 1.500 - 3.000 V. en clara adaptación a la eliminación de recorridos a 1.500v. que venía realizando Renfe.

El primer servicio prestado por los 444 fue el nuevo Intercity entre Madrid y Valencia por Albacete el 1 de junio de 1980, en un servicio creado para estos trenes y atendido por cuatro trenes en cada sentido diariamente. Uno de los servicios se prolongaba hasta Castellón.

La velocidad media de este servicio era superior a los 100 km/h., ofreciendo comodidades como restauración para los viajeros de primera clase en su asiento incluido en el precio del billete, prensa, megafonía y servicio de azafatas.

El servicio prestado con estos trenes pronto se aplicó a otras relaciones donde comenzó a denominarse como servicio Electrotren, sobre nombre con el que serían conocidos estos magníficos trenes. Los nuevos servicios de largo recorrido encargados a los Electrotrenes 444 fueron Barcelona - Sevilla, Madrid - Sevilla y Barcelona - Málaga.

La incorporación de nuevos Electrotrenes 444.500 permitió ampliar las relaciones Electrotren a Madrid - Zaragoza, Madrid - Alicante, Madrid - Hendaya, Madrid - Gijón, Barcelona - Irún, Barcelona - Gijón o Vigo - Hendaya, entre otros.





## 444 ELECTROTREN - HO 1:87

Chasis metálico en coche motor  
Motor de cinco polos  
Enganche Scharfenberg funcional en frontales  
Iluminación interior e iluminación en cabina  
Conector NEM 660 21-pin MTC para decoder digital  
Interior detallado  
Luces blancas y rojas direccionales  
Rádio de giro mínimo R1 356 mm.  
Pantógrafos metálicos

HE2020 RENFE. automotor eléctrico 444-004. decoración rojo/amarillo. ép.IV



Versión de origen.  
Testeros con puertas de intercomunicación.  
Decoración rojo/amarillo.  
Desde 1980 a 1990

HN2021 RENFE. automotor eléctrico 444-503. decoración "Estrella". ép.IV



Subserie 500.  
Nuevos testeros de fibra.  
Decoración marrón / crema.  
Desde 1988 a 1994

HN2022 RENFE. automotor eléctrico 444-011. decoración azul/blanca. ép. V



Suprimida cafetería y nuevos asientos.  
Testeros con puertas de intercomunicación.  
Decoración azul / blanco.  
Desde 1990 a 1994





HE2020/HE2020S



RENFE

**NEW**

**RENFE, automotor eléctrico 444-004, decoración rojo/amarillo, ép.IV**

RENFE, elektrischer Triebzug der Reihe 444, Triebzug 444-004 in rot-gelber Farbgebung, Epoche IV

RENFE, automotrice électrique classe 444, immatriculée 444-004, livrée rouge/jaune, ép. IV

RENFE, elettromotrice classe 444-004, livrea rossa/gialla, ep. IV

RENFE, 3-unit EMU class 444, unit 444-004 in original red/yellow livery, ep. IV



Photo: I. Martín Yunta



HE2021/HE2021S



RENFE

**NEW**

**RENFE, automotor eléctrico 444-503, decoración "Estrella", ép.IV**

RENFE, elektrischer Triebzug der Reihe 444-500, Triebzug 444-503 in „Estrella“-Farbgebung, Epoche IV

RENFE, automotrice électrique classe 444, immatriculée 444-503, livrée « Estrella », ép. IV

RENFE, elettromotrice classe 444-503, livrea "Estrella", ep. IV

RENFE, 3-unit EMU class 444-500, unit 444-503 in "Estrella" livery, ep. IV



Photo: I. Martín Yunta



HE2022/HE2022S



RENFE

**NEW**

**RENFE, automotor eléctrico 444-011, decoración azul/blanca, ép. V**

RENFE, elektrischer Triebzug der Reihe 444, Triebzug 444-011 in blau-weißer Farbgebung, Epoche V

RENFE, automotrice électrique classe 444, immatriculée 444-011, livrée bleue/blanche, ép. V

RENFE, elettromotrice classe 444-011, livrea blu/bianca, ep. V

RENFE, 3-unit EMU class 444, unit 444-011 in blue-white livery, ep. V



Photo: I. Martín Yunta







# Automotor 443 El "Platanito"



## 443 el "Platanito"

El Electrotrén Basculante 443, mejor conocido como "Platanito", fue el primer contacto de España con la alta velocidad. Su concepción italiana, prevista para aumentar las velocidades en curva, hacía uso de la llamada Basculación Activa, una tecnología pionera que consistía en inclinar las cajas de los coches en curva, aumentando la velocidad de los trenes a su paso por esta, sin interferir en la comodidad de los viajeros. Asombrada por los resultados del prototipo italiano, la dirección de RENFE decidió a finales de los años 70 solicitar un prototipo adaptado a la red española, que fue entregado en 1976. El "Platanito" alcanzó los 200 km/h durante su primer año de pruebas, y visitó gran parte de nuestra geografía, prestando servicio incluso comercial por varias líneas de la Red Nacional. Durante años ostentó el récord de velocidad en España, de 206,8 km/h. Desafortunadamente, durante esas pruebas sufrió una avería de la cual no consiguió recuperarse. La falta de repuestos y el coste que suponían, al tratarse de una sola unidad, precipitó su baja. Desde entonces permaneció en el depósito de Fuencarral con un incierto destino, llegando incluso a firmarse su orden de desguace. Afortunadamente pudo salvarse y, desde 1994, se encuentra apartado en una de las vías de la estación de Castejón de Ebro, bajo el cuidado desinteresado de un grupo de voluntarios que siguen velando por él.

Un vehículo tan popular y a la vez único merecía ser reproducido y rodar por las maquetas de los aficionados. Es nuestra forma de rendir homenaje a este mítico automotor. Y es que, el "Platanito" es, por encima de todo y al igual que nosotros, un Electrotrén.





HE2016/HE2016S



RENFE

### RENFE, electrotrén basculante clase 443, con techo amarillo y logo antiguo, ép. IV

RENFE, Hochgeschwindigkeits-Neigezug Rh. 443, mit gelbem Dach und altem Logo, Ep. IV

RENFE, coffret de 4 unités, automotrice électrique à assiette variable classe 443, avec toit jaune et ancien logo, ép. IV

RENFE, set di 4 unità, elettrotreno ad assetto variabile ad alta velocità classe 443, con tetto giallo e logo vecchio, ep. IV

RENFE, tilting high-speed EMU class 443, with yellow roof and old logo, ep. IV

#### Características del modelo:

- Enganches con conexión eléctrica entre coches
- Motor de 5 polos con volantes de inercia
- Chasis en metal para todos los coches
- Interior detallado
- Luces blancas o rojas en función del sentido de la marcha
- Luz interior
- Conector MTC de 21 pines (NEM660)
- Versiones digitales con sonido utilizando decoder ESU LokSound V5
- Pantógrafos metálicos de acabado fino y robusto con distintas versiones según época
- Longitud entre extremos: 1.220 mm
- Radio mínimo: 356,5 mm



Diferentes pantógrafos para cada versión



HE2017/HE2017S



RENFE

### RENFE, electrotrén basculante clase 443, versión de fábrica, ép. IV

RENFE, Hochgeschwindigkeits-Neigezug Rh. 443, Werksversion, Ep. IV

RENFE, coffret de 4 unités, automotrice électrique à assiette variable classe 443, version d'usine, ép. IV

RENFE, set di 4 unità, elettrotreno ad assetto variabile ad alta velocità classe 443, versione di fabbrica, ep. IV

RENFE, tilting high-speed EMU class 443, factory version, period IV

#### El modelo 443 y sus versiones

La referencia **HE2017** reproduce el modelo recién construido, sin matriculas ni inscripciones corporativas de RENFE, tal y como se presentó en fábrica para las primeras pruebas. Se dotó de un pantógrafo convencional de doble frotador, llantas en blanco y el primitivo esquema frontal en ángulo recto. La referencia **HE2016** reproduce el modelo ya en servicio en la Red, con el esquema frontal de pintura definitivo, matriculas e inscripciones completas y pantógrafo de frotador sencillo, pintado en negro para las pruebas de circulación.



Llantas de rueda en color blanco







Pantógrafos en color negro



Testero con distinta franja marrón



Pantógrafos en color rojo



Testero sin franja marrón





HE4027

III-IV 773 L Ew K

CIWL - RENFE

**NEW**

**CIWL, primer set de 3 coches "Sud-Expreso", compuesto de un coche DD3, un AA 5000 y un WL, ép. III-IV**

CIWL, 3-teilige Zugpackung „Sud-Expreso“ (Set 1/2), bestehend aus DD3, AA 5000 + WL, Ep. III-IV

CIWL, coffret de 3 voitures « Sud Express », set 1/2 (DD3, AA 5000 + WL), ép. III-IV

CIWL, set di 3 carrozze «Sud-expreso», set 1/2 (DD3, AA 5000 + WL), ep. III-IV

CIWL, 3-unit pack "Sud-expreso", set 1/2 (DD3 + AA 5000 green with stripes and bellows + WL), ep. III-IV



Ejes para sistema AC: HC6104 (11.50 x 24.50 mm)

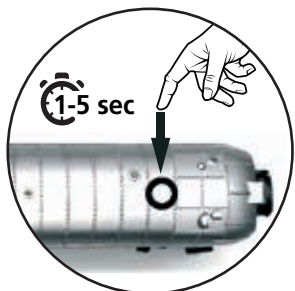

**Coches equipados con iluminación interior con control táctil para activar y variar la intensidad**



Fotomontage / Fotomontaje / Photomontage / Fotomontaggio



HE4028

III-IV

801



CIWL

**NEW**

**CIWL, segundo set de 3 coches "Sud-Expreso", compuesto de un coche VPC "Étoile du Nord" y dos WL, ép. III-IV**

CIWL, 3-teilige Zugpackung „Sud-Expreso“ (Set 2/2), bestehend aus VPC Étoile du Nord + WL + WL, Ep. III-IV

CIWL, coffret de 3 voitures « Sud Express », set 2/2 (VPC Étoile du Nord + WL + WL), ép. III-IV

CIWL, set di 3 carrozze "Sud-expreso", set 2/2 (VPC Étoile du Nord + WL + WL), ep. III-IV

CIWL, 3-unit pack "Sud-expreso", pack 2/2 (VPC Étoile du Nord + WL + WL), ep. III-IV



Ejes para sistema AC: HC6104 (11.50 x 24.50 mm)

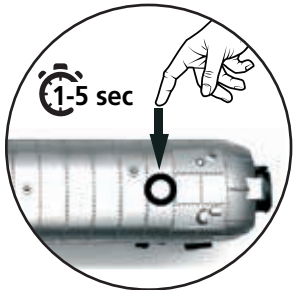

**Coches equipados con iluminación interior con control táctil para activar y variar la intensidad**



Fotomontage / Fotomontaje / Photomontage / Fotomontaggio





HE4035

IV K

RENFE

**NEW**

**RENFE, set complementario "Costa Brava", compuesto de un restaurante RRR-8000 en decoración azul-amarillo y dos literas BBL-8100 en decoración "Estrella", ép.IV**

RENFE, 3-teiliges Ergänzungset „Costa Brava“, enthält einen blau-gelben Speisewagen sowie zwei Liegewagen in „Estrella“-Farbgebung, Ep. IV

RENFE, coffret de 3 voitures complémentaires « Costa Brava », composé de 1 voiture restaurant en livrée bleue et de 2 voitures couchettes en livrée « Estrella », ép. IV

RENFE, set di 3 carrozze complementari "Costa Brava" comprendente una carrozza ristorante blu e due carrozze cuccette in livrea "Estrella", ep. IV

RENFE, 3-unit complimentary set "Costa Brava" including a blue restaurant coach and two couchette coaches in "Estrella" livery, ep. IV



Ejes para sistema AC: HC6102 (10.50 x 24.50 mm)



HE4036

IV K

RENFE

**NEW**

**RENFE, set de 2 coches literas BBL-8100, decoración verde oliva, ép. IV**

RENFE, 2-tlg. Set Liegewagen BBL-8100 in olivgrüner Farbgebung, Ep. IV

RENFE, coffret de 2 voitures couchettes BBL-8100, livrée vert olive, ép. IV

RENFE, set di 2 carrozze cuccette BBL-8100, livrea verde oliva, ep. IV

RENFE, 2-unit pack of couchette coaches BBL-8100 in olive green livery, ep. IV



Ejes para sistema AC: HC6102 (10.50 x 24.50 mm)

**Características del modelo:**

- Carrocerías y techos de nuevo molde para coches litera de 11 departamentos
- Interiores detallados, con literas y departamento del literista
- Escalerillas interiores de las literas en metal fotograbado
- Sets en decoración "Estrella", incluyendo restaurante con decoración época IV, y verde oliva, con ligeras diferencias entre coches
- Enganche corto ajustable en longitud
- Topes funcionales





HE4033



RENFE

NEW

**RENFE, coche BB-8937, de 2ª clase, con ventanas anchas, decoración "Estrella", ép.IV**

RENFE, 4-achs. Schnellzugwagen 2. Klasse, BB-8937 mit 1,20-m-Fenstern in „Estrella“-Farbgebung, Ep. IV

RENFE, voiture de train express de 2ème classe BB-8937, avec des fenêtres de 1,20 m de large en livrée « Estrella », ép. IV

RENFE, carrozza per treni espressi di 2a classe BB-8937, con finestrini larghi 1,20 m in livrea "Estrella", ep. IV

RENFE, 2nd class express train coach BB-8937, with 1,20 m wide windows in "Estrella" livery, ep. IV

Ejes para sistema AC: HC6102 (10.50 x 24.50 mm)

**Características del modelo:**

- Carrocería de 2ª clase con ventanas anchas de 1,200 mm, de serie alta
- Primera vez que se fabrica en decoración "Estrella", sin reformar
- Ideal para complementar composiciones como el Expreso "Costa Brava"
- Enganche corto ajustable en longitud
- Topes funcionales



HE4021



RENFE

NEW

**RENFE, set de 2 furgones postales P3-3100, con bogies para 160 km/h, decoración amarillo, ép. IV-V**

RENFE, 2-tlg. Set Postwagen P3-3100 mit 160-km/h-Drehgestellen in gelber Farbgebung, Ep. IV-V

RENFE, coffret de 2 fourgons postaux P3-3100 avec bogies pour 160 km/h, livrée jaune, ép. IV-V

RENFE, set di 2 furgoni postali P3-3100 con carrelli per 160 km/h, livrea gialla, ep. IV-V

RENFE, 2-unit pack of postal vans P3-3100 with 160 km/h, yellow livery, ep. IV-V

Ejes para sistema AC: HC6102 (10.50 x 24.50 mm)



Nuevo bogie GC3





HE4029

V <sup>245</sup>

RENFE

**NEW**

**RENFE, coche B7r-6260, con fuelles, decoración "Regionales", ép. V**

RENFE, Wagen B7r-6260, in Ursprungsausführung mit Faltenbälgen in „Regionales“-Farbgebung, Ep. V

RENFE, voiture B7r-6260, avec soufflets d'origine, livrée « Regionales », ép. V

RENFE, carrozza B7r-6260, con mantici di origine, livrea "Regionales", ep. V

RENFE, coach B7r-6260, with original bellows in "Regionales" livery, ep. V



Ejes para sistema AC: HC6104 (11.50 x 24.50 mm)



HE4030

IV <sup>246</sup>

RENFE

**NEW**

**RENFE, coche S-1033 "Manso", con fuelles, decoración "Regionales", ép. V**

RENFE, Wagen S-1033 „Manso“, in Ursprungsausführung mit Faltenbälgen in „Regionales“-Farbgebung, Ep. V

RENFE, voiture S-1033 « Manso », avec soufflets d'origine, livrée « Regionales », ép. V

RENFE, carrozza S-1033 "Manso", con mantici di origine, livrea "Regionales", ep. V

RENFE, coach S-1033 "Manso", with original bellows in "Regionales" livery, ep. V



Ejes para sistema AC: HC6104 (11.50 x 24.50 mm)







HE4031

IV

246

L

K

RENFE

NEW

**ADIF, coche SSV-1041 "Tajo de Vía", decoración verde/gris, ép. VI**

ADIF, Bauzugwagen SSV-1041 „Tajo de Vía“ in grün-grauer Farbgebung, Ep. VI

ADIF, voiture SSV-1041 « Tajo de Vía », livrée verte/grise, ép. VI

ADIF, carrozza SSV-1041 "Tajo de Vía", livrea verde/grigio, ep. VI

ADIF, coach SSV-1041 "Tajo de Vía" on green and grey livery, ep. VI



Ejes para sistema AC: HC6104 (11.50 x 24.50 mm)



HE4032

IV

246

L

K

RENFE

NEW

**RENFE, coche PSSV "Herbicida", decoración verde/blanca, ép. V-VI**

RENFE, Wagen PSSV Unkrautvernichtungszug in grün-weißer Farbgebung, Ep. VI

RENFE, voiture PSSV train désherbeur, livrée verte/blanche, ép. V-VI

RENFE, carrozza PPSV "Herbicida", livrea verde/bianca, ep. V-VI

RENFE, coach PSSV "Herbicida" in green and white livery, ep. VI



Ejes para sistema AC: HC6104 (11.50 x 24.50 mm)





HE6068

IV  $\frac{170}{\leftarrow \rightarrow}$  K

RENFE

**RENFE, vagón tolva de 4 ejes TT5 con paredes planas, decoración rojo oxido, «Metransa», ép. IV**

RENFE, 4-achs. Schwenkdachwagen TT5 in oxidroter Farbgebung, „Metransa“, Ep. IV

RENFE, wagon-trémie à 4 essieux TT5, livrée rouge oxyde, « Metransa », ép. IV

RENFE, carro tramoggia a 4 assi TT5 con pareti piatte, livrea rosso vagone, "Metransa", ep. IV

RENFE, 4-axle hopper wagon TT5, oxid red livery, "Metransa", ep. IV

Ejes para sistema AC: HC6100 (10.27 x 25.20 mm)



HE6071

IV  $\frac{121}{\leftarrow \rightarrow}$  K

RENFE

**NEW**

**RENFE, vagón cerrado tipo J2, decoración «Bultaco», ép. IV**

RENFE, 2-achs. gedeckter Güterwagen der Bauart J2, mit Werbeaufschrift für Motorräder der Marke „Bultaco“, Ep. IV

RENFE, wagon fermé à 2 essieux type J2, livrée « Bultaco », ép. IV

RENFE, carro chiuso a 2 assi tipo J2, livrea "Bultaco", ep. IV

RENFE, 2-axle closed wagon type J2, with advertising for motorcycles "Bultaco", ep. IV

Ejes para sistema AC: HC6101 (11.27 x 24.25 mm)



Fotomontage / Fotomontaje / Photomontage / Fotomontaggio



HE6073

III-IV <sup>240</sup> K

RENFE

**NEW**

**RENFE, set de 2 vagones cisterna PR de gas, decoración " Butano S.A. " plata/negro, ép. III-IV**

RENFE, 2-tlg. Set 2-achs. Gaskesselwagen PR, „Butano S.A.“, silber-schwarze Farbgebung, Ep. III-IV

RENFE, coffret de 2 wagons gaziers à 2 essieux PR, « Butano S.A. », livrée argent/noire, ép. III-IV

RENFE, set di 2 carri cisterna a 2 assi PR, "Butano S.A.", livrea argento/nera, ep. III-IV

RENFE, 2-unit pack of 2-axle gas tank wagons PR, "Butano S.A.", silver/black livery ep. III-IV

Ejes para sistema AC: HC6101 (11.27 x 24.25 mm)



HE6070

IV <sup>240</sup> K

RENFE

**NEW**

**RENFE, set de 2 vagones cisternas PR de gas, decoración "Saltra", ép. IV-V**

RENFE, 2-tlg. Set 2-achs. Gaskesselwagen Zgkk, „Saltra“, Epoche IV

RENFE, coffret de 2 wagons gaziers à 2 essieux PR, « Saltra », ép. IV

RENFE, set di 2 carri cisterna a 2 assi per trasporto gas PR, "Saltra", ep. IV

RENFE, 2-unit pack of 2-axle gas tank wagons type Zgkk, "Saltra", ep. IV

Ejes para sistema AC: HC6101 (11.27 x 24.25 mm)



HE6066

IV <sup>242</sup> K

TRANSFESA

**RENFE, set de 2 vagones cisterna de gas de 2 ejes PR, "Repsol Butano", ép. IV**

RENFE, 2-tlg. Set 2-achs. Gaskesselwagen PR, „Repsol Butano“, Ep. IV

RENFE, coffret de 2 wagons-citernes à gaz à 2 essieux PR, "Repsol Butano", ép. IV

RENFE, set di 2 carri cisterna a 2 assi PR, "Repsol Butano", ep. IV

RENFE, 2-unit set of 2-axle gas tank wagons PR, "Repsol Butano", period IV

Ejes para sistema AC: HC6101 (11.27 x 24.25 mm)







HE6051

IV <sup>246</sup> K

RENFE

**RENFE, set de 2 vagones cisternas de 3 ejes, «Saltra», ép. IV**

RENFE, 2-tlg. Set 3-achs. Kesselwagen, „Saltra”, Ep. IV

RENFE, coffret de 2 wagons-citernes à 3 essieux, « Saltra », ép. IV

RENFE, set di 2 carri cisterna a 3 assi, “Saltra”, ep. IV

RENFE, 2-unit set of 3-axle tank wagons, “Saltra”, period IV

Ejes para sistema AC: HC6101 (11.27 x 24.25 mm)

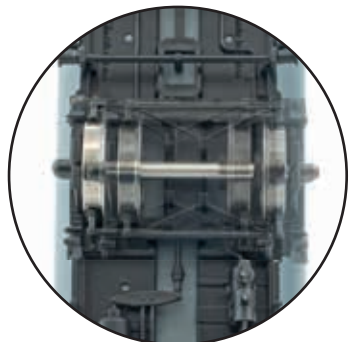

Eje central desplazable



HE6052

III-IV <sup>246</sup> K

RENFE

**RENFE, set de 2 vagones cisternas de 3 ejes, «Borges», ép. III-IV**

RENFE, 2-tlg. Set 3-achs. Kesselwagen, „Borges”, Ep. III-IV

RENFE, coffret de 2 wagons-citernes à 3 essieux, « Borges », ép. III-IV

RENFE, set di 2 carri cisterna a 3 assi, “Borges”, ep. III-IV

RENFE, 2-unit set of 3-axle tank wagons, “Borges”, period III-IV

Ejes para sistema AC: HC6101 (11.27 x 24.25 mm)



**HE6062****IV****304****K****TRANSFESA****TRANSFESA, vagón articulado entoldado tipo Lails de 3 ejes, logo grande, ép. IV**

TRANSFESA, dreiachsiger Schiebeplanenwagen Lails, mit großem Logo, Ep. IV

TRANSFESA, wagon bâché à 3 essieux type Lails, avec grand logo, ép. IV

TRANSFESA, carro articolato a 3 assi telonato tipo Lails, logo grande, ep. IV

TRANSFESA, 3-axle tarpaulin wagon type Lails, large logo, ep. IV

Ejes para sistema AC: HC6103

**HE6077****VI****304****K****TRANSFESA/Hispanauto****NEW****TRANSFESA/Hispanauto, vagón portacoches tipo Laeks "Mega Car Carrier", decoración azul/plata, ép. VI**

TRANSFESA/Hispanauto, 3-achs. Autotransportwagen Laeks „Mega Car Carrier“, silber-blaue Farbgebung, Ep. VI

TRANSFESA/Hispanauto, wagon porte-autos à 3 essieux Laeks « Mega Car Carrier », livrée argent/bleue, ép. VI

TRANSFESA/Hispanauto, carro trasporto auto a 3 assi tipo Laeks "Mega Car Carrier", livrea argento/blu, ep. VI

TRANSFESA/Hispanauto, 3-axle car transporter Laeks "Mega Car Carrier", silver/blue livery, ep. VI

Ejes para sistema AC: HC6103

*Fotomontage / Fotomontaje / Photomontage / Fotomontaggio*

105







# Ya disponible • Schon verfügbar • Déjà disponible • Già disponibile • Already Available

**Algunos de los productos marcados como ya disponibles podrían estar agotados ya.**

*Einige der hier als bereits verfügbar gekennzeichneten Produkte können bereits ab Lager ausverkauft sein.*

*Certains produits annoncés comme encore « en stock » pourraient être déjà épuisés*

*I prodotti qui mostrati come disponibili potrebbero essere già esauriti.*

*Some items shown here as still available could already be sold out ex-works.*



**E2415**

Locomotora diésel 316 (1602) "Vias"



**HE2002/HE2002D/HE2002S**

RENFE, set de 2 unidades, automotor diésel «Ferrobus» serie 591.500, decoración «Regionales», ép. V



**HE2003D/HE2003S**

RENFE, set de 3 unidades, automotor diésel «Ferrobus», serie 591.300, con matrícula UIC, ép. IV - 70° Aniversario Electrotren



**E2642S**

COMSA, locomotora eléctrica serie 269-045-1, ép. VI



**HE2005**

RENFE, locomotora eléctrica clase 279, decoración verde/amarillo, ép. IV



**HE2006/HE2006D/HE2006S**

RENFE, locomotora eléctrica clase 279, decoración «Taxi», ép. V



**E3465**

RENFE, set de tres unidades, automotor eléctrico de alta velocidad S-490 "Alaris", decoración original azul/blanco, ép. V



**E3360**

RENFE, Trenhotel Talgo, sleeping coach with door on the left side, original blue/beige livery, period IV



**E5096**

RENFE, coche serie 5000 "manso" decoración "Regionales", ép. V





### HE4001

RENFE, set de dos furgones DD-8100, decoración rojo Paquexpres, ép. V



### HE4002

RENFE, furgón D11-11400, decoración verde, ép. IV



### HE4013

RENFE, set de 2 furgones postales DGDC-3000, decoración verde oliva, ép. III-IV



### HE4015

RENFE, set de 3 unidades compuesto de 1 coche 12000 y 2 vagones PMM (1 cargado con tanque), decoración verde oliva, ép. V



### HE4016

RENFE, set de 3 coches «Media Luna», compuesto de 1 coche camas T2 en decoración azul, 1 coche de primera clase 12100 en decoración «Estrella» y 1 coche camas 7100 en decoración «Estrella», ép. IV



### HE4018

ADIF, coche SSV-500 «Maquinaria de vía», decoración verde, ép. VI



### HE4019

RENFE set de 3 coches «Estrella Picasso», decoración «Largo Recorrido», compuesto de 2 coches literas 11600 y 1 coche cama 7100, ép. V



### HE4020

RENFE, set de 3 coches «Costa Brava», decoración verde oliva, compuesto de 1 coche RRR-8000, 1 coche BB y 1 coche BBL, ép. IV



### HE4022

RENFE, furgón postal DGDC-3000, decoración verde con franjas amarillas, ép. III



### HE4024

RENFE, coche bar 5000, decoración «Estrella», ép. IV



### HE4025

RENFE, set de 2 coches 5000, decoración verde oliva, compuesto de 1 furgón BBD4 y 1 coche bar AAR, ép. IV



### HE4026

RENFE, set de 2 coches 5000 de segunda clase BB4, decoración verde oliva, ép. IV



**E19046**

RENFE, vagón dos ejes ORE cerrado con paredes de madera, decoración gris, "Macosa", ép. III

**E19047**

RENFE, vagón dos ejes ORE cerrado con paredes de madera, decoración "Babcox & Wilcox", ép. III

**HE6009**

R.N., set de 2 vagones cubiertos de 2 ejes PX, decoración gris, «Ensidesa», ép. III

**HE6010**

RENFE, set de dos vagones cubiertos de dos ejes PX "Naviera Astur Andaluza", ép. III

**HE6022**

RENFE, set de 2 vagones cisternas de 3 ejes, decoración gris, «Koipe», ép. IV

**HE6023**

RENFE, set de 2 vagones cisternas de 3 ejes, decoración gris, «Campsa», ép. III

**HE6024**

RENFE, set de 2 vagones cisternas de 3 ejes, decoración gris, «Elosua», ép. IV

**HE6027**

RENFE, vagón cisterna de 4 ejes Uahs, decoración "Saltra Explosivos de Rio Tinto", ép. IV

**HE6029**

RENFE, set de 2 vagones cisternas de 2 ejes, decoración gris, «Koipe», ép. IV

**HE6033**

RENFE, vagón plataforma de 4 ejes MMQ, cargado de rollos de alambrión, ép. IV

**HE6034**

RENFE, vagón plataforma de 4 ejes MMQC, cargado con contenedor frigorífico «Pescanova», ép. IV

**HE6035**

RENFE, vagón plataforma de 4 ejes Ladks, decoración amarilla "Semat", cargado con 4 Citroen 2CV "Correos" amarillo, ép. IV







**HE6042**

SNCF, vagón de 3 ejes Lails con toldo, decoración gris con logo «Transfesa» pequeño, ép. IV



**HE6043**

SNCF, vagón de 3 ejes Lails con toldo, decoración gris con logo «Transfesa» grande, ép. IV-V



**HE6045**

TRANSFESA, vagón porta contenedores de 4 ejes MMC3, cargado con un contenedor de 45' «Boluda», ép. VI



**HE6046**

RENFE, vagón de paredes correzidas de 4 ejes JJPD, decoración marrón/plata, ép. IV



**HE6047**

RENFE, vagón tolva de 4 ejes con paredes planas Tagpp para cereales, decoración verde/gris, «Merconidera», ép. V



**HE6054**

RENFE, vagón cisterna de 4 ejes, decoración cromada, «Saltra/Rio Gulf», ép. III



**HE6055**

R.N., vagón cerrado de 2 ejes PJ, «Mahou», ép. III



**HE6056**

R.N., vagón cerrado de 2 ejes PJ, «Talbot», ép. III



**HE6057**

R.N., vagón cerrado de 2 ejes PJ, «Ebro», ép. III



**HE6059**

NORTE, vagón para el transporte de vino, «Anis del Mono», ép. III



**HE6060**

NORTE, vagón para el transporte de vino, «Antonino Mendieta - Vinos Bilbao», ép. III



**HE6061**

NORTE, vagón para el transporte de vino, «V.M. Lecea - Vagones Cubas Madrid», ép. III





### HE6063

RENFE, vagón porta contenedores de 4 ejes MMC3, decoración azul, cargado con 2 contenedores para bobinas de 20' «Cadefer/Railsider», ép. VI



### HE6064

RENFE, vagón porta contenedores de 4 ejes MMC3, decoración azul, cargado con 2 contenedores para bobinas de 20' «Tramesa», ép. VI



### HE6069

RENFE, vagón porta contenedores de 4 ejes MMC3, cargado con un contenedor de 45' «DHL», ép. V



© Enrique Dopico



# Índice • Index

Locomotoras diésel . . . . . 200

Productos disponibles . . . . . 201

*Diesel locomotives . . . . . 200*

*Productos disponibles . . . 201*

**Electrotren<sup>®</sup>**  
Hobby

Con Electrotren Hobby nació una gama de producto con el espíritu de crear modelos de trenes a precios asequibles.

Todo ello con el enfoque en la robustez del producto, facilitando la entrada en el hobby ferroviario a nuevos aficionados. Por supuesto sin abandonar la alta calidad de los productos Electrotren.

Como segundo modelo de esta gama presentamos el automotor diésel 596 “Tamagotchi”. Este modelo siempre se presenta con dos matrículas diferentes para aprovechar su enganche funcional tipo “Scharfenberg” que permite acoplar varias unidades.







HE2501A



RENFE

NEW

**RENFE, automotor diesel 596-003, decoración "Media Distancia", ép. VI**

RENFE, Dieseltriebwagen 9-596-003-4, in „Media Distancia“-Farbgebung, Epoche VI

RENFE, autorail diesel 9-596-003-4, livrée « Media Distancia », ép. VI

RENFE, automotrice diesel 9-596-003-4, livrea "Media Distancia", ep. VI

RENFE, diesel railcar 9-596-003-4, "Media Distancia" livery, ep. VI



Enganche Scharfenberg

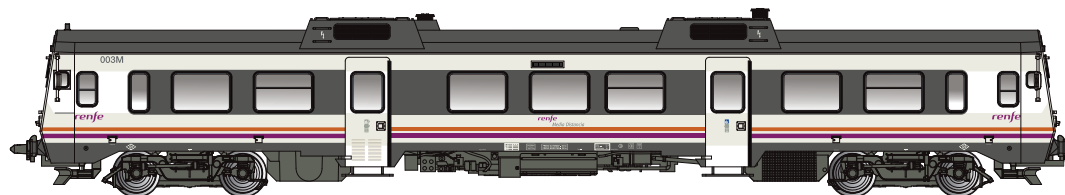

HE2501B

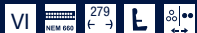

RENFE

NEW

**RENFE, automotor diesel 596-005, decoración "Media Distancia", ép. VI**

RENFE, Dieseltriebwagen 9-596-005-9, in „Media Distancia“-Farbgebung, Epoche VI

RENFE, autorail diesel 9-596-005-9, livrée « Media Distancia », ép. VI

RENFE, automotrice diesel 9-596-005-9, livrea "Media Distancia", ep. VI

RENFE, diesel railcar 9-596-005-9, "Media Distancia" livery, ep. VI



Enganche funcional

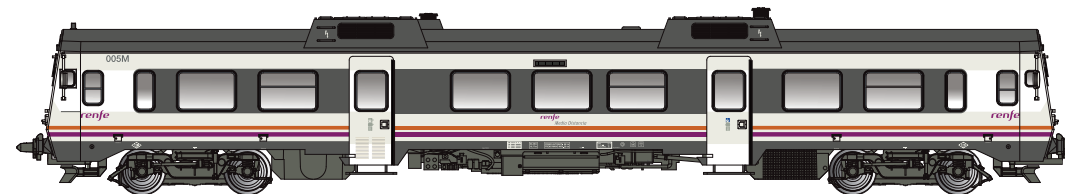



HE2503



RENFE

**NEW**

**RENFE, automotor diesel 596-004, decoración "Regionales R2" con logo moderno, ép. V-VI**

RENFE, Dieseltriebwagen 9-596-004-2 in „Regionales R2“-Farbgebung mit neuem Logo, Epoche V-VI

RENFE, autorail diesel 9-596-004-2, livrée « Regionales R2 » avec nouveau logo, ép. V-VI

RENFE, automotrice diesel 9-596-004-2, livrea "Regionales R2" con logo nuovo, ep. V-VI

RENFE, diesel railcar 9-596-004-2, "Regionales R2" livery with new logo, ep. V-VI

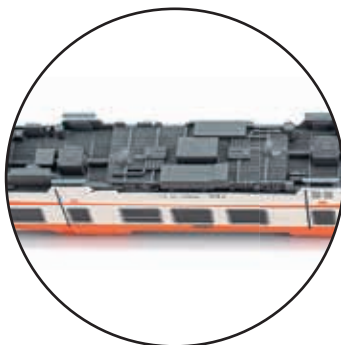

Bajos detallados

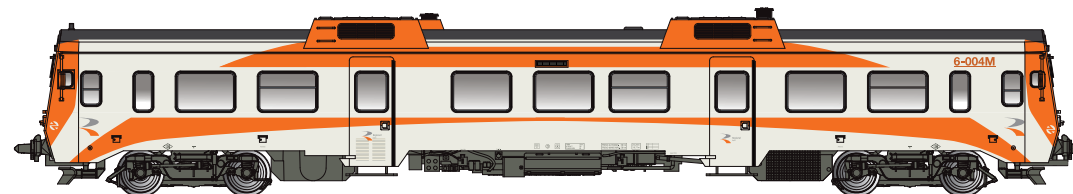

HE2505



RENFE

**NEW**

**RENFE, automotor diesel 596-006, decoración blanca, ép. VI**

RENFE, Dieseltriebwagen 9-596-006-7 in weißer Farbgebung, Epoche V-VI

RENFE, autorail diesel 9-596-006-7, livrée blanche, ép. V-VI

RENFE, automotrice diesel 9-596-006-7, livrea bianca, ep. V-VI

RENFE, diesel railcar 9-596-006-7, white livery, ep. V-VI

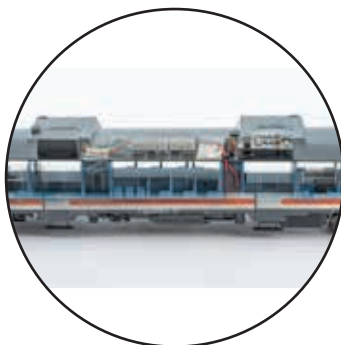

Interior con detalle

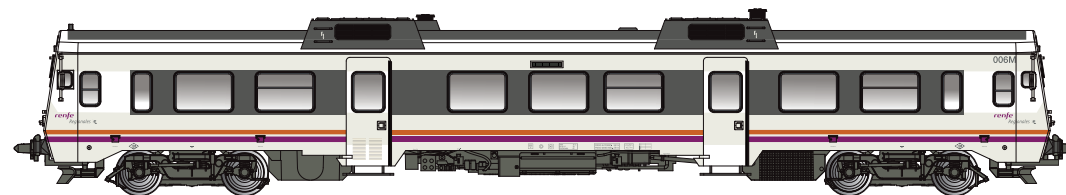



# Ya disponible • Schon verfügbar • Déjà disponible • Già disponibile • Already Available

**Algunos de los productos marcados como ya disponibles podrían estar agotados ya.**

*Einige der hier als bereits verfügbar gekennzeichneten Produkte können bereits ab Lager ausverkauft sein.*

*Certains produits annoncés comme encore « en stock » pourraient être déjà épuisés*

*I prodotti qui mostrati come disponibili potrebbero essere già esauriti.*

*Some items shown here as still available could already be sold out ex-works.*



**HE2500A**

RENFE, automotor diesel 596, decoración «Regionales R1», 9-596-006-7, ép. V



**HE2500B**

RENFE, automotor diesel 596, decoración «Regionales R1», 9-596-003-4, ép. V



**HE2502A**

RENFE, automotor diesel 596, decoración «Regionales R2», 9-596-002-6, ép. V



**HE2502B**

RENFE, automotor diesel 596, decoración «Regionales R2», 9-596-001-8, ép. V



**HN2504A**

RENFE, automotor diesel 596, decoración «Media Distancia», 9-569-005-9, ép. VI



**HN2504B**

RENFE, automotor diesel 596, decoración «Media Distancia», 9-569-003-4, ép. VI



**E10200**

RENFE, set de 4 unidades, automotor eléctrico de alta velocidad S-114, ép. VI



**E10201/E10201D**

RENFE, set de 4 unidades, automotor eléctrico de alta velocidad S-114 decoración "75 aniversario RENFE", ép. VI









## Indice • Index

Locomotive a vapore. . . . .	120
Locomotive diesel . . . . .	132
Locomotive elettriche . . . . .	142
Carrozze . . . . .	164
Carri . . . . .	184
Prodotti disponibili . . . . .	200

<i>Steam locomotives. . . . .</i>	<i>120</i>
<i>Diesel locomotives. . . . .</i>	<i>132</i>
<i>Electric locomotives. . . . .</i>	<i>142</i>
<i>Coaches . . . . .</i>	<i>164</i>
<i>Wagons . . . . .</i>	<i>184</i>
<i>Available Products . . . . .</i>	<i>200</i>

 **Rivarossi**<sup>®</sup>

Rivarossi è da ormai quasi 80 anni il riferimento del fermodellismo italiano. Grandi dettagli, curati finemente, e una lunga storia lo hanno reso un marchio sinonimo di qualità.

Siamo lieti di presentare in questo catalogo tutte le nostre novità, che, come ogni anno, abbiamo selezionato con cura cercando di andare incontro alle esigenze dei modellisti. Anche il catalogo 2024 quindi è ricco di proposte: oltre alla conferma di progetti annunciati in precedenza, come la locomotiva a vapore FS Gr. 685 e la “draisina” KLV 53, tra i nuovi annunci vi sono anche, a grande richiesta, le locomotive elettriche E656/E655 “Caimano” delle FS interamente riprogettate secondo gli standard qualitativi odierni, che vanno a completare la grande famiglia di locomotive articolate FS.

Ma non vi è solo materiale motore: anche per carrozze e carri stiamo procedendo con l’ampliamento dell’offerta, con nuove versioni di carrozze CIWL ed UIC-X non riprodotte in precedenza ed una vasta scelta di carri merci di diverse tipologie ed amministrazioni, per tutti i gusti.

Abbiamo lavorato duramente per mantenere standard di altissima eccellenza, con un occhio di riguardo ai nostri appassionati che per noi sono fonte instancabile d’ispirazione. Rivarossi sei tu, che dal modellismo ferroviario pretendi sempre il meglio!



[www.rivarossi.com](http://www.rivarossi.com)







# FS Gr. 685



## Locomotiva FS.685

Le locomotive del gruppo 685 sono la versione a vapore surriscaldato e a semplice espansione della precedente serie di locomotive del gruppo 680 delle Ferrovie dello Stato di cui ricalcano l'impostazione meccanica generale e le dimensioni. Furono costruite su progetto dell'Ufficio Studi di Firenze delle FS in 241 esemplari con distribuzione Walschaerts e 30 con distribuzione a valvole sistema Caprotti (queste ultime inizialmente classificate nel gruppo 686), entrate in servizio a partire dal 1912. Successivamente, tra il 1921 e il 1930 iniziò la trasformazione in 685 di un consistente quantitativo di locomotive 680 che diede origine alle serie 685.300 (con distribuzione Walschaerts) e 685.500 (con distribuzione Caprotti). Tra 1931 e 1934 un ulteriore gruppo di 50 unità 680 venne trasformato mediante l'applicazione della distribuzione Caprotti, di un surriscaldatore e di un preriscaldatore Knorr dando luogo al sottogruppo S.685.

La locomotiva 685 rappresenta senz'altro il compendio della massima espressione tecnologica italiana legata alla trazione ferroviaria a vapore e non a caso questa macchina, che in mani esperte era capace di regalare ottime prestazioni, venne affettuosamente ed informalmente ribattezzata "La Regina". Le unità del gruppo prestarono un importante servizio attivo fino agli anni '60.



**FS, locomotiva a vapore Gr. 685, 2a serie, con caldaia corta, locomotiva storica, ep. V-VI**

FS, Dampflokomotive Gr. 685, 2. Serie, mit kurzem Kessel, historische Lokomotive, Ep. V-VI

FS, locomotive à vapeur Gr. 685, 2<sup>ème</sup> série, avec chaudière courte, locomotive historique, ép. V-VI

FS, locomotora de vapor Gr 685, segunda serie, con caldera corta, locomotora histórica, ép. V-VI

FS, steam locomotive Gr. 685 089, 2nd series, with short boiler, historic locomotive, period V-VI

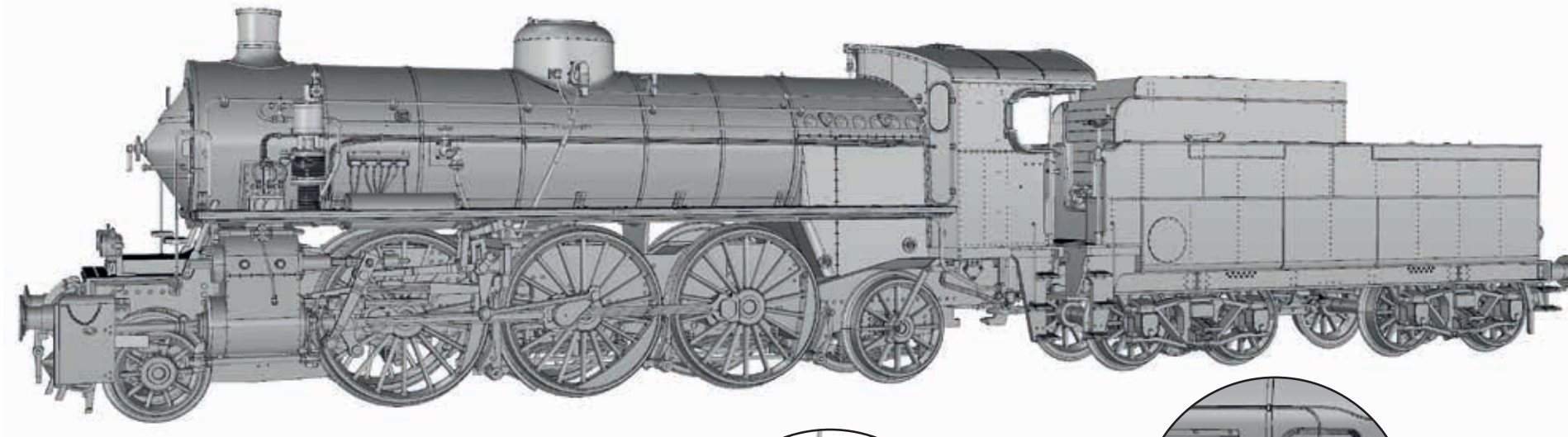
**Il nuovissimo modello Rivarossi nei punti chiave:**

- Riproduzione in perfetta scala H0 1:87 delle unità di prima e seconda serie con caldaia corta
- Tender FS a carrelli da 22 m3 interamente di nuova costruzione
- Interfaccia 21MTC (NEM 660) per decoder digitale nel tender
- Predisposizione per impianto sonoro con due altoparlanti "sugar cube" nel tender
- Telaio, ruote e caldaia in metallo pressofuso
- Telaio finemente riprodotto e dettagliato, con struttura "aperta"
- Riproduzione funzionante delle bielle motrici interne al telaio
- Ruote motrici con bordino ribassato a norme NEM 311.1 e razze in scala
- Cinematismo di allontanamento tra macchina e tender, con condotta elettrica e regolabile in lunghezza
- Portagancio NEM 362 con timone di allontanamento sulla testata posteriore del tender
- Possibilità di installazione del gancio modellistico a norma NEM 363 sulla testata anteriore della macchina
- Riproduzione completa della cabina di guida, con illuminazione interna
- Illuminazione del forno
- Fanali anteriori a petrolio o elettrici in base alla versione, entrambi illuminati
- Fanali posteriori sul tender presenti su alcune versioni, riproduzione delle lanterne di coda opzionali
- Raggio minimo di curvatura: 420 mm

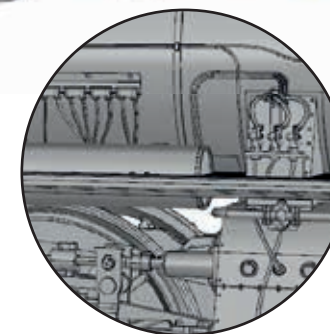
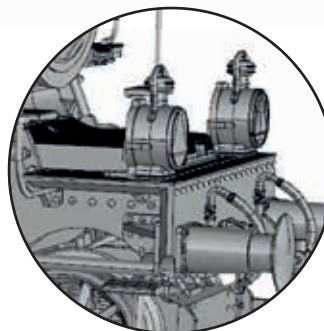

- Con forno illuminato (DC) o scoppiettante (in digitale)
- Mit glühender (DC) bzw. flackerner (im Digitalbetrieb) Feuerbüchse
- Avec boîte à feu lumineuse (DC) ou scintillant (en mode digital)
- Con fogón iluminado (DC) o parpadeando (en modo digital)
- With glowing (DC) or flickering (in digital mode) firebox



**HR2914/HR2914S****FS****NEW****FS, locomotiva a vapore Gr. 685, 2a serie, con caldaia corta e fanali a petrolio, ep. III**

FS, Dampflokomotive Gr. 685, 2. Serie, mit kurzem Kessel und Öllampen, Ep. III

FS, locomotive à vapeur Gr. 685, 2<sup>ème</sup> série, avec chaudière courte et lampes à huile, ép. III

FS, locomotora de vapor Gr 685, segunda serie, con caldera corta y luces a petroleo, ép. III

FS, steam locomotive Gr. 685, 2nd series, with short boiler and oil lamps, period III



- Con forno illuminato (DC) o scoppiettante (in digitale)
- Mit glühender (DC) bzw. flackerner (im Digitalbetrieb) Feuerbüchse
- Avec boîte à feu lumineuse (DC) ou scintillant (en mode digital)
- Con fogón iluminado (DC) o parpadeando (en modo digital)
- With glowing (DC) or flickering (in digital mode) firebox

**HR2915/HR2915S****FS****NEW****FS, locomotiva a vapore Gr. 685, 1a serie, con caldaia corta e fanali elettrici, ep. III**

FS, Dampflokomotive Gr. 685, 1. Serie, mit kurzem Kessel und elektrischen Lampen, Ep. III

FS, locomotive à vapeur Gr. 685, 1<sup>ère</sup> série, avec chaudière courte et lampes électriques, ép. III

FS, locomotora de vapor Gr 685, primera serie, con caldera corta y luces eléctricas, ép. III

FS, steam locomotive Gr. 685, 1st series, with short boiler and electric lamps, period III

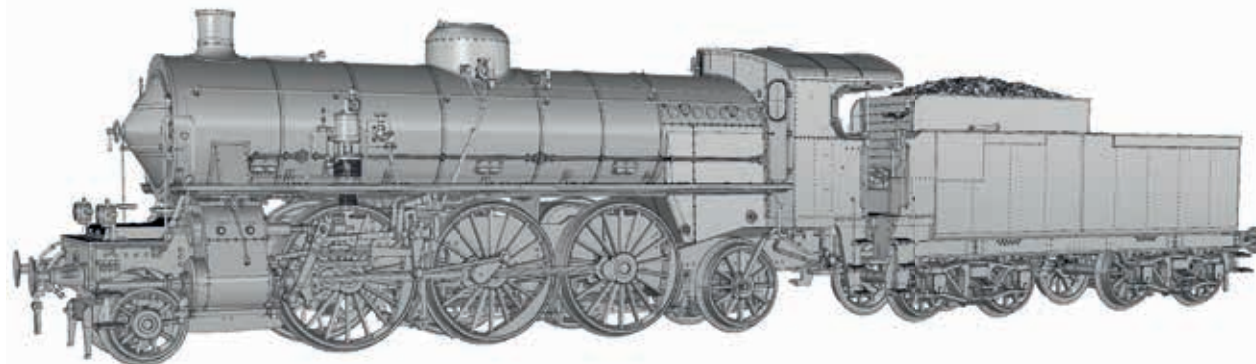

- Con forno illuminato (DC) o scoppiettante (in digitale)
- Mit glühender (DC) bzw. flackerner (im Digitalbetrieb) Feuerbüchse
- Avec boîte à feu lumineuse (DC) ou scintillant (en mode digital)
- Con fogón iluminado (DC) o parpadeando (en modo digital)
- With glowing (DC) or flickering (in digital mode) firebox







HR2956/HR2956S



FS

NEW

**FS, locomotiva a vapore Gr. 940, con fanali a petrolio, ep. III**

FS, vierachsige Tenderlokomotive der Reihe 940, mit Öllampen, Ep. III

FS, locomotive à tender à vapeur Gr. 940, avec lampes à huile, ép. III

FS, locomotora de vapor Gr. 940, con lámparas de aceite, ép. III

FS, steam tender locomotive Gr. 940, with oil lamps, ep. III

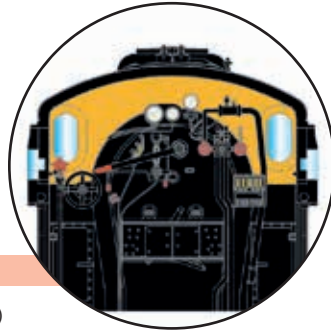

**Locomotiva Gr. 940**

- Nuovo impianto elettrico con interfaccia per decoder (NEM 662)
- Nuovo impianto sonoro, con altoparlante "sugar cube" 11 x 15 mm
- Versioni DCC Sound di fabbrica, mai prodotte in precedenza
- Nuova riproduzione della traversa completa del carrello anteriore
- Nuovi dettagli su caldaia, cabina e sottocassa differenziati in base all'epoca
- Numerazioni inedite

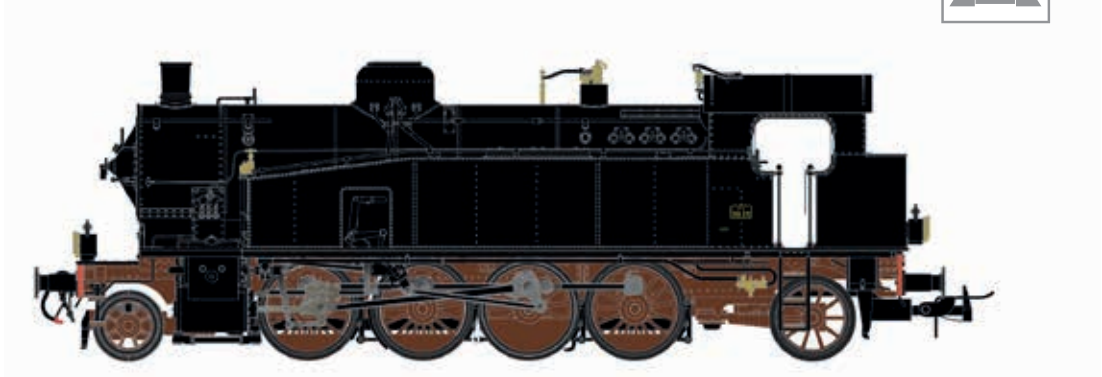

HR2957/HR2957S



FS

NEW

**FS, locomotiva a vapore Gr. 940, con fanali elettrici, ep. III-IV**

FS, vierachsige Tenderlokomotive der Reihe 940, mit elektrischen Lampen, Ep. III-IV

FS, locomotive à tender à vapeur Gr. 940, avec lampes électriques, ép. III-IV

FS, locomotora de vapor Gr. 940, con lámparas de eléctricas, ép. III-IV

FS, steam tender locomotive Gr. 940, with electric lamps, ep. III-IV

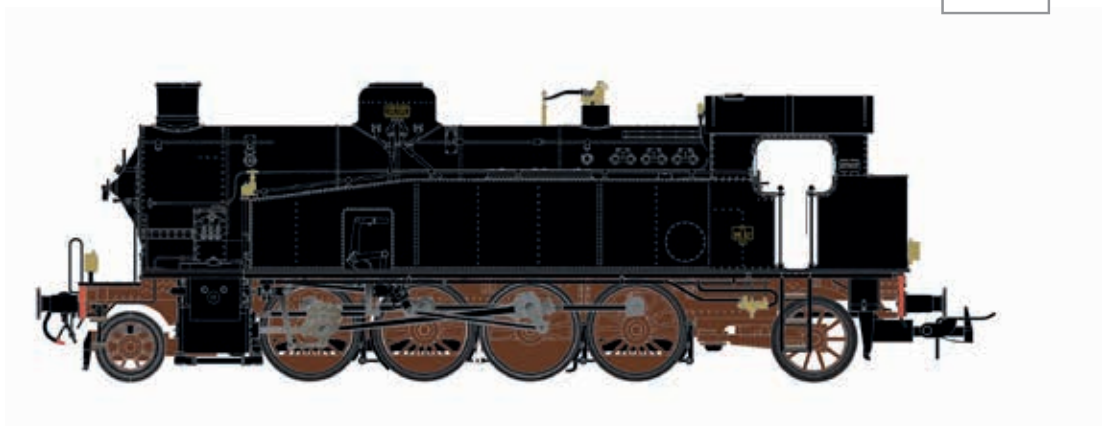
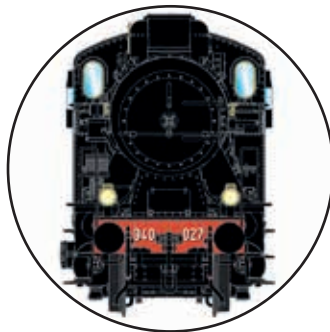

**DB, locomotiva a vapore classe 56.20, caldaia con 3 duomi, livrea nera/rossa, ep. III**

DB, Dampflokomotive Baureihe 56.20, dreidomiger Kessel, in schwarz/roter Lackierung, Ep. III

DB, locomotive à vapeur classe 56.20, chaudière avec 3 coupoles, livrée noire/rouge, ép. III

DB, locomotora de vapor clase 56.20, caldera con 3 domos, decoración negra/roja, ép. III

DB, steam locomotive class 56.20, 3-dome boiler, black/red livery, period III

**Die Dampflokomotiven der Bauart G 8.3 (BR 56<sup>20</sup>)**

Im Zusammenhang mit der Entwicklung der fünffach gekuppelten Güterzuglokomotive der Gattung G 12 kam der Wunsch nach einer vierfach gekuppelten Maschine für den mittelschweren Dienst auf. So leitete man aus der 1'Eh3 Lok der Gattung G 12 die 1'Dh3 Lokomotiven der Gattung G 8.3 ab.

Allerdings blieben diese Lokomotiven hinsichtlich Leistung und Verbrauch deutlich hinter den Erwartungen zurück, so das nach 85 gebauten Exemplaren der einfacheren Zweizylinder-Bauart G 8.2 (1'Dh2) der Vorzug gegeben wurde.

Insgesamt verließen 846 Lokomotiven diese Typs bis 1928 die Werkhallen mehrerer deutscher Lokomotivwerke. Haupteinsatzgebiete waren Mittel- und Westdeutschland in den Direktionen Köln, Essen, Hannover, Münster, Altona, Magdeburg und Halle(Saale).

Dort bewältigten sie zum größten Teil den hochwertigen Güterverkehr, kamen aber auch vor Reisezügen zum Einsatz.

Nach dem zweiten Weltkrieg verblieben mehr als 500 Maschinen der Baureihe 5620 in der Bundesrepublik Deutschland, sie wurden bis 1963 durch andere Lokomotivbauarten verdrängt und ausgemustert.

Bei der DR in der Deutschen demokratischen Republik konnten sie bis 1970 im Einsatz beobachtet werden, einige davon als Rangierlokomotiven mit speziellen Tritten an der rechten Lokfront.



© Willi Marotz

- Con forno illuminato (DC) o scoppiettante (in digitale)
- Mit glühender (DC) bzw. flackerner (im Digitalbetrieb) Feuerbüchse
- Avec boîte à feu lumineuse (DC) ou scintillant (en mode digital)
- Con fogón iluminado (DC) o parpadeando (en modo digital)
- With glowing (DC) or flickering (in digital mode) firebox





**HR2890/HR2890S****DR****DR, locomotiva a vapore classe 56.20, caldaia con 3 duomi, livrea nera/rossa, ep. III**

DR, Dampflokomotive Baureihe 56.20, dreidomiger Kessel, in schwarz/roter Lackierung, Ep. III  
 DR, locomotive à vapeur classe 56.20, chaudière avec 3 coupoles, livrée noire/rouge, ép. III  
 DR, locomotora de vapor clase 56.20, caldera con 3 domos, decoración negra/roja, ép. III  
 DR, steam locomotive class 56.20, 3-dome boiler, black/red livery, period III

- Con forno illuminato (DC) o scoppiettante (in digitale)
- Mit glühender (DC) bzw. flackerner (im Digitalbetrieb) Feuerbüchse
- Avec boîte à feu lumineuse (DC) ou scintillant (en mode digital)
- Con fogón iluminado (DC) o parpadeando (en modo digital)
- With glowing (DC) or flickering (in digital mode) firebox



© Photo Mag. A. Luft

**HR2891/HR2891S/HR2891ACS****DRG****DRG, locomotiva a vapore classe 56.20, caldaia con 3 duomi, livrea nera/rossa, ep. II**

DRG, Dampflokomotive Baureihe 56.20, dreidomiger Kessel, in schwarz/roter Lackierung, Ep. II  
 DRG, locomotive à vapeur classe 56.20, chaudière avec 3 coupoles, livrée noire/rouge, ép. II  
 DRG, locomotora de vapor clase 56.20, caldera con 3 domos, decoración negra/roja, ép. II  
 DRG, steam locomotive class 56.20, 3-dome boiler, black/red livery, period II

- Con forno illuminato (DC) o scoppiettante (in digitale)
- Mit glühender (DC) bzw. flackerner (im Digitalbetrieb) Feuerbüchse
- Avec boîte à feu lumineuse (DC) ou scintillant (en mode digital)
- Con fogón iluminado (DC) o parpadeando (en modo digital)
- With glowing (DC) or flickering (in digital mode) firebox



© Photo Carl Bellingrodt



HR2892/HR2892S



DB

**DB, locomotiva a vapore 055 632-4, livrea nera/rossa, ep. IV**

DB, Dampflokomotive mit Schlepptender 055 632-4, in schwarz-roter Farbgebung, Ep. IV

DB, locomotive à vapeur 055 632-4, livrée noire/rouge, ép. IV

DB, locomotora de vapor 055 632-4, decoración negro/rojo, ép. IV

DB, steam locomotive with tender 055 632-4, black/red livery, ep. IV



Fotomontage / Fotomontaje / Photomontage / Fotomontaggio

- Con forno scoppiettante
- Mit flackerner Feuerbüchse
- Avec boîte à feu scintillant
- Con fogón parpadeante
- With flickering firebox



**Feinste Detaillierung  
entsprechend des Vorbilds**





HR2893/HR2893S



DR

**DR, locomotiva a vapore 55 7254, livrea nera/rossa, ep. III**

DR, Dampflokomotive mit Schlepptender 55 7254, in schwarz-roter Farbgebung, Ep. III

DR, locomotive à vapeur 55 7254, livrée noire/rouge, ép. III

DR, locomotora de vapor 55 7254, decoración negro/rojo, ép. III

DR, steam locomotive with tender 55 7254, black/red livery, ep. III



© Collection Dirk Endisch

- Con forno scoppiettante
- Mit flackerner Feuerbüchse
- Avec boîte à feu scintillant
- Con fogón parpadeante
- With flickering firebox



17

**Stromlinienzug**  
mit Dampflokomotive für 170 km Stf.

17

**Stromlinienzug**  
mit Dampflokomotive für 170 km Stf.

17 Stromlinienzug

### Stromlinienzug

Die Übergabe der Lokomotive fand am 31. Mai 1935 statt. Zugelassen war sie für eine Geschwindigkeit von bis zu 175 km/h, die mit den 2.300 Millimeter großen Treibrädern auch erreicht wurden, allerdings unter starken Zuckbewegungen, die auf das Zwei-Zylinder-Triebwerk zurückzuführen waren und sich sogar auf den Zug übertrugen. Man wollte daher der Lok keine Fahrplangeschwindigkeiten von bis zu 160 km/h zumuten und setzte deshalb diesen Stromlinienzug im Planverkehr zwischen Berlin und Dresden ein, wo die Höchstgeschwindigkeit damals bei 135 km/h lag. Die nach vorn abgeschrägtem Wasserbehälter gewährten Lokführer und Heizer eine rundum gute Streckensicht. Der „Blechmantel“, so die amtliche Beschreibung, verkleidete das Triebwerk komplett. Hier ist der Zug bei der Ausstellung zur Hundertjahrfeier der deutschen Eisenbahnen in Nürnberg zu sehen.



**HR2953/HR2953S****DRG****NEW****DRG, locomotiva a vapore ad alta velocità 61 001, livrea definitiva con treno Henschel-Wegmann (4 carrozze), ep. II**

DRG, Stromliniendampflokomotive 61 001 in endgültiger Farbgebung mit vierteiligem Henschel-Wegmann-Zug, Ep. II

DRG, locomotive à vapeur à grande vitesse 61 001, livrée définitive avec train Henschel-Wegmann (4 voitures), ép. II

DRG, locomotora de vapor de alta velocidad 61 001, decoración final con Henschel-Wegmann-Zug, ép. II

DRG, high-speed steam locomotive 61 001, final livery with Henschel-Wegmann train (4 coaches), ep. II

**Henschel-Wegmann-Zug**

Der Henschel-Wegmann-Zug wurde zunächst auf der Ausstellung zum 100-jährigen Bestehen der Deutschen Eisenbahnen vom 14. Juli bis 13. Oktober 1935 in Nürnberg ausgestellt und ging dann zur weiteren Bearbeitung nach Kassel. Mit Inkrafttreten des Sommerfahrplans 1936 befuhr die Henschel-Wegmann-Zug die Strecke Berlin – Dresden mit zwei Zugpaaren pro Tag. Dabei benötigte er für ein Strecke eine Stunde und 40 Minuten und übertraf damit den bisherigen Rekord um 28 Minuten, ein Rekord, der bis heute Bestand hat. In den offiziellen Berechnungen maß die Reichsbahn ihre Geschwindigkeit nur zwischen Berlin und der Dresdner Neustadt und vernachlässigte damit die letzten Kilometer bis zum Dresdner Hauptbahnhof. So konnte die Durchschnittsgeschwindigkeit des Zuges mit 111,2 km/h angegeben werden. Die kurze Wendezeit in Dresden zwischen den Verbindungen D 54 und D 57 war offensichtlich recht knapp.

Wie sich herausstellte, musste die Lokomotive nicht nur um den Zug herumfahren, sondern auch ihre Vorräte auffüllen. Zum Glück musste sie nicht zusätzlich noch auf der Drehscheibe gedreht werden. Dieses Wendezeitproblem wurde von der Reichsbahn im Winterfahrplan 1936 behoben.

**Das neue Rivarossi-Modell im Detail**

- Vollständige Neukonstruktion
- Viele angesetzte Details, größtenteils aus Metall
- Feine Speichenradsätze aus Metallspritzguss
- Spitzenbeleuchtung mit der Fahrtrichtung wechselnd
- Bestellnummern, die mit „S“ enden, sind ab Werk mit Sound ausgestattet
- Kurzkupplungskinematiken an beiden Enden der Lokomotive
- Mindestradius: 356,5 mm

## DRG 61 001

Die Henschel-Wegmann-Zuggarnitur sollte in Konkurrenz zu den Dieseltriebwagen, die an den jeweiligen Endbahnhöfen einen schnellen Richtungswechsel erlaubten, fahren. Es war daher beabsichtigt, möglichst auf zeitraubende Prozeduren, wie beispielsweise das bei Schleptender-Schnellzuglokomotiven in aller Regel notwendige Wenden auf einer Drehscheibe, zu verzichten. Hieraus leitete sich ab, dass die Lokomotive der Zuggarnitur in beide Fahrrichtungen mit der gleichen Höchstgeschwindigkeit fahren können sollte, weshalb man sie als Tenderlokomotive ausführte.

Um die vorgesehenen Fahrleistungen erzielen zu können, wurde die Lokomotive ebenso wie die Wagen besonders leicht ausgelegt; die Kohle- und Wasservorräte bemaß man gerade ausreichend für eine einfache Fahrt auf der vorgesehenen Strecke.

Mit den 2,30 Meter durchmessenden Treibrädern erreichten die Lokomotiven ohne unzulässig hohe Triebwerks-Drehzahlen und Kolbengeschwindigkeiten die vorgesehene

Höchstgeschwindigkeit von 175 km/h problemlos; die Lok 61 001 schaffte bei Versuchsfahrten eine maximale Geschwindigkeit von 185 km/h. Mit dem Stromlinienzug wurde aber nur Tempo 130 gefahren. Der Plandienst zwischen Dresden und Berlin wurde erfolgreich durchgeführt, die 176 Kilometer lange Strecke in nur 102 Minuten bewältigt, eine Zeit, die auf dieser Strecke bis heute (2011) trotz schnellerer Elektrolokomotiven nicht unterboten wurde.

Recht knapp bemessen war dabei die Aufenthaltszeit des Zuges in Dresden, da die Lok nicht nur an das andere Zugende umsetzen, sondern infolge der knapp bemessenen Vorräte auch noch diese erneuert werden mussten.

Bei einem Ausfall der Lok 61 001 oder der Wagengarnitur wegen planmäßiger oder außerplanmäßiger Arbeiten setzte man eine Lok der Baureihe 01 oder Baureihe 03 ein. Mit 130 km/h erreichten sie die Höchstgeschwindigkeit der 61 001 jedoch nicht.

Nach Einstellung des Zugbetriebes bei Kriegsbeginn 1939 wurde die 61 001 zum Heizdienst in Bahnbetriebswerk Berlin-Grünwald eingesetzt. Ab Dezember 1940 befand sie sich wieder in Dresden-Alttstadt im Schnellzugdienst und erhielt im November 1942 konventionelle Zug- und Stoßvorrichtungen.

Auch die auffällige Farbgebung wurde durch grau ersetzt. Später wurde auch der untere Teil der Verkleidung entfernt, damit das Triebwerk besser zugänglich war. Die Betriebsprotokolle weisen nur geringe Laufleistungen aus. Von 1943 bis Kriegsende war das Ausbesserungswerk Braunschweig für die Lok zuständig. Zwischen Juli 1945 und März 1946 legte sie rund 40.000 Kilometer vor Personenzügen zurück.







HR2954/HR2954S



DRG

**NEW**

**DRG, locomotiva a vapore ad alta velocità 61 001, livrea rossa, ep. II**

DRG, Stromliniendampflokomotive 61 001 in roter Farbgebung, Ep. II

DRG, locomotive à vapeur à grande vitesse 61 001, livrée rouge, ép. II

DRG, locomotora de vapor de alta velocidad 61 001, decoración roja, ép. II

DRG, high-speed steam locomotive 61 001, red livery, ep. II



Fotomontage / Fotomontaje / Photomontage / Fotomontaggio



HR2955/HR2955S



DB

**NEW**

**DB, locomotiva a vapore ad alta velocità 61 001, livrea nera con strisce, ep. III**

DB, Stromliniendampflokomotive 61 001 in schwarzer Farbgebung mit Zierstreifen, Ep. III

DB, locomotive à vapeur à grande vitesse 61 001, livrée noire avec rayures, ép. III

DB, locomotora de vapor de alta velocidad 61 001, decoración negro con franjas, ép. III

DB, high-speed steam locomotive 61 001, black with stripes, ep. III



Fotomontage / Fotomontaje / Photomontage / Fotomontaggio

131

# Vossloh DE 18





**DB/NorthRail, locomotiva diesel Vossloh DE 18, livrea grigia, ep. VI**

DB/NorthRail, Diesellokomotive Vossloh DE 18, in hellgrauer Farbgebung, Ep. VI

DB/NorthRail, locomotive diesel Vossloh DE 18, livrée grise, ép. VI

DB/NorthRail, locomotora diesel Vossloh DE 18, decoración gris, ép. VI

DB/NorthRail, diesel locomotive Vossloh DE 18, grey livery, ep. VI



© Jürgen Lorenz

**Vossloh DE 18 Diesellokomotive**

Bei der Vossloh DE 18 handelt es sich um die erste Lokomotive aus dem ehemaligen MaK-Werk Kiel seit der Einstellung der Produktion der DE 1002 im Jahr 1993.

Seit ihrer Markteinführung 2014 hat Vossloh mehr als 130 DE 18 Lokomotiven an Kunden in verschiedenen europäischen Ländern verkauft, die heute zuverlässig ihren Dienst sowohl im Rangier- als auch Streckenbetrieb leisten – so auch für die DB, die SNCF und seit kurzem auch die italienische FS.

**Das brandneue Rivarossi-Modell in Stichpunkten:**

- Vollständige Neuentwicklung
- Chassis aus Zinkdruckguss, Gehäuse auch hochwertigem, fein graviertem Kunststoff
- Fünfpoliger Hochleistungsmotor mit Schwungmassen
- Alle vier Achsen angetrieben
- Stromabnahme über alle Räder der Lokomotive
- Länge über Puffer: 195 mm
- Mindestradius: 356,5 mm
- Spitzenbeleuchtung mit der Fahrtrichtung wechselnd
- Rote Schlussleuchten mit der Fahrtrichtung wechselnd und im Digitalbetrieb separat schaltbar
- Innenbeleuchtung im Führerhaus
- Kurzkupplungskulissen beidseitig
- Kupplungsaufnahmen nach NEM 362 beidseitig
- Digitalschnittstelle nach NEM 660 (21-pin MTC)



HR2921/HR2921S



RailAdventure

NEW

**RailAdventure, locomotiva diesel Vossloh DE 18, livrea grigia, ep. VI**

RailAdventure, Diesellokomotive Vossloh DE 18, in grauer Farbgebung, Ep. VI

RailAdventure, locomotive diesel Vossloh DE 18, livrée grise, ép. VI

RailAdventure, locomotora diesel Vossloh DE 18, decoración gris, ép. VI

RailAdventure, diesel locomotive Vossloh DE 18, grey livery, ep. VI



© Martin Morlowsky



HR2969/HR2969S



FS Mercitalia Shunting & Terminal

NEW

**FS Mercitalia S&T, locomotiva diesel Vossloh DE 18, livrea grigia, ep. VI**

FS Mercitalia S&T, Diesellokomotive des Typs Vossloh DE 18 in hellgrauer Farbgebung, Ep. VI

FS Mercitalia S&T, locomotive diesel Vossloh DE 18, livrée grise, ép. VI

FS Mercitalia S&T, locomotora diesel Vossloh DE 18, decoración gris, ép. VI

FS Mercitalia S&T, diesel locomotive Vossloh DE 18, grey livery, ep. VI



**DE 18 FS Mercitalia Shunting & Terminal**

- Riproduzione di griglie e pannelli degli avancorpi specifici per la versione italiana della DE 18
- Cabina con porta a destra e banco di comando a sinistra in entrambi i sensi di marcia
- Captatori SSC sul ricasco del tetto della cabina
- Riproduzione del carica batterie e delle apparecchiature sottocassa specifici per la versione italiana
- Tutte le scritte di servizio coerenti con la versione riprodotta





**CD Cargo, locomotiva diesel Effishunter 1000, livrea blu, nuovo numero di servizio, ep. VI**

CD Cargo, Diesellokomotive des Typs Effishunter 1000, blaue Farbgebung mit neuer Betriebsnummer, Epoche VI

CD Cargo, locomotive diesel Effishunter 1000, livrée bleue, nouvelle immatriculation, ép. VI

CD Cargo, locomotora diesel Effishunter 1000, decoración azul, nueva matricula, ép. VI

CD Cargo, diesel locomotive Effishunter 1000, blue, new running number, ep. VI

**Effishunter 1000**

- Riproduzione accurata di tutti i dettagli su cofani, cabina, telaio e sottocassa coerentemente differenziati in base all'unità riprodotta
- Affidabile meccanica con telaio e scatole ingranaggi in metallo, potente motore centrale a 5 poli con trasmissione a doppio albero cardanico su entrambi gli assi dei carrelli, due ruote con anello di aderenza
- Impianto elettrico con presa 21 poli NEM 660/21MTC per decoder DCC e DCC Sound, con predisposizione per altoparlante "sugar cube" 11 x 15 mm.
- Versioni "S" con decoder sonoro ed altoparlante installati di serie, con suoni specifici per il modello
- Luci bianche di testa e rosse di coda con commutazione automatica in base al senso di marcia e con possibilità di esclusione indipendente tra le due testate
- Terzo faro con comando indipendente dai fanali bassi
- Illuminazione interna in cabina, con interni fedelmente riprodotti, sedili macchinista riportati
- Carrelli estremamente realistici, con numerosi pezzi riportati per sospensione secondaria, smorzatori, cacciapietre, sabbiere, impianto frenante e coperchi boccole con relativi cavi
- Numerosi particolari riportati in metallo o plastica per il massimo realismo
- Livree e numerazioni inedite



Exhaust pipe panelling  
made from photo-etched



Fine detailed bogies with  
metal brake discs



Fine detailed front with separate  
and functional light housings

**HR2923/HR2923S****DINAZZANO PO/TPER****NEW****Dinazzano Po/TPER, locomotiva diesel da manovra EffiShunter 1000, livrea arancio/grigia, ep. VI**

Dinazzano Po/TPER, Diesellokomotive EffiShunter 1000, in orange/grauer Farbgebung, Ep. VI

Dinazzano Po/TPER, locomotive de manoeuvre diesel EffiShunter 1000, livrée orange/grise, ép. VI

Dinazzano Po/TPER, locomotora de maniobras diesel EffiShunter 1000, decoración naranja/gris, ép. VI

Dinazzano Po/TPER, diesel shunting locomotive EffiShunter 1000, orange/grey livery, ep. VI

**EffiShunter 1000**

Le locomotive diesel EffiShunter 1000 sono attualmente il prodotto di punta della CZ Loko per quanto riguarda le macchine destinate a servizi di manovra pesante, in scali ferroviari o raccordi industriali, oltre a servizi di linea.

Sono dotate di un moderno sistema di gestione della potenza e della trazione che permette un'elevata efficienza della macchina e bassi consumi, così come del sistema di segnalamento europeo ETCS, che insieme a tutte le altre caratteristiche tecniche garantiscono il certificato STI per l'interoperabilità sulle principali reti europee.

Queste macchine sono al momento operative o in ordine presso numerose imprese ferroviarie sia statali private in Italia, Repubblica Ceca, Slovenia e Norvegia, ed essendo ancora in produzione altri ordini potranno arrivare in futuro.

**HR2924/HR2924S****FNM/TRENORD****NEW****FNM/Trenord, locomotiva diesel da manovra EffiShunter 1000, livrea grigia/blu/verde, ep. VI**

FNM/Trenord, Diesellokomotive EffiShunter 1000, in grau/blau/grüner Farbgebung, Ep. VI

FNM/Trenord, locomotive de manoeuvre diesel EffiShunter 1000, livrée grise/bleue/verte, ép. VI

FNM/Trenord, locomotora de maniobras diesel EffiShunter 1000, decoración gris/azul/verde, ép. VI

FNM/Trenord, diesel locomotive EffiShunter 1000, grey/blue/green livery, ep. VI







HR2931/HR2931S



FS

**FS, locomotiva diesel da manovra gruppo 245, senza corrimani laterali, livrea verde con strisce gialle, ep. IV**

FS, Diesel-Rangierlokomotive Rh. 245, ohne seitliche Geländer, in grüner Lackierung mit gelbem Streifen, Ep. IV

FS, locomotive de manœuvre diesel classe 245, sans mains courantes latérales, livrée verte avec bandes jaunes, ép. IV

FS, locomotora de maniobras 245, sin pasamanos laterales, decoración verde con franjas amarillas, ép. IV

FS, diesel shunting locomotive class 245, without side handrails, green livery with yellow stripes, period IV



Fotomontage / Fotomontaje / Photomontage / Fotomontaggio



HR2932/HR2932S



Mercitalia Shunting & Terminal

**Mercitalia Shunting & Terminal, locomotiva diesel da manovra gruppo 245, livrea rossa/grigio scura con strisce bianche, ep. VI**

Mercitalia Shunting & Terminal, Diesel-Rangierlokomotive Rh. 245 in rot/dunkelgrauer Lackierung mit weißem Streifen, Ep. VI

Mercitalia Shunting & Terminal, locomotive de manœuvre diesel classe 245, livrée rouge/gris foncé avec bandes blanches, ép. VI

Mercitalia Shunting & Terminal, locomotora de maniobras 245, decoración roja/gris oscura con franjas blancas, ép. VI

Mercitalia Shunting & Terminal, diesel shunting locomotive class 245, red/dark grey livery with white stripes, period VI



Fotomontage / Fotomontaje / Photomontage / Fotomontaggio



**DB AG, draisina KLV 53, livrea gialla con logo DB AG, ep. V**

DB AG, Rottenkraftwagen KLV 53 in gelber Lackierung mit „DB AG“-Logo, Ep. V

DB AG, draine KLV 53, livree jaune avec logo DB AG, ep. V

DB AG, dresina KLV 53, decoracion amarillo con logo DB AG, ep. V

DB AG, maintenance vehicle type KLV 53, yellow livery with DB AG logo, period V



**Il nuovissimo modello Rivarossi nei punti chiave:**

- Vollständige Neukonstruktion
- Viele angesetzte Details
- Feine Speichenradsätze aus Metallspritzguss
- Frei beweglicher Kran am Heck des KLV
- Spitzenbeleuchtung mit der Fahrtrichtung wechselnd (nicht bei allen Modellvarianten)
- 18-polige Digitalchnittstelle nach NEM 662
- Bestellnummern, die mit „D“ enden, sind ab Werk mit Digitaldecoder ausgestattet
- Bestellnummern, die mit „S“ enden, sind ab Werk mit Sound ausgestattet
- Stromführende Magnetkupplung zwischen KLV und Anhänger



**Fein detaillierte Kabine**



© Wolfgang Mauser





## HR2909/HR2909D/HR2909S



FS

### FS, draisina KLV 53, livrea gialla RFI, ep. V-VI

FS, Rottenkraftwagen KLV 53 in gelber „RFI“-Lackierung, Ep. V-VI

FS, draisine KLV 53, livrée jaune « RFI », ép. V-VI

FS, dresina KLV 53, decoración amarillo «RFI», ép. V-VI

FS, maintenance vehicle type KLV 53, yellow "RFI" livery, period V-VI



© Luca Bergamini



## HR2910/HR2910D/HR2910S



SIRTI

### Draisina KLV 53, livrea gialla, "Sirti", ep. V

Rottenkraftwagen KLV 53 in gelber Lackierung, „Sirti“, Ep. V

Draisine KLV 53, livrée jaune, « Sirti », ép. V

Dresina KLV 53, decoración amarillo, «Sirti», ép. V

Maintenance vehicle type KLV 53, yellow livery, "Sirti", period V



© Rosario Palomba





## HR2912/HR2912D/HR2912S



### DB, draisina KLV 53, livrea gialla, ep. IV

DB, Rottenkraftwagen KLV 53 in gelber Lackierung, Ep. IV

DB, draisine KLV 53, livrée jaune, ép. IV

DB, dresina KLV 53, decoración amarillo, ép. IV

DB, maintenance vehicle type KLV 53, yellow livery, period IV



© Svetlana Linberg



## HR2913/HR2913D/HR2913S



### BASF, draisina KLV 53, livrea verde, ep. V

BASF, Rottenkraftwagen KLV 53 in grüner Lackierung, Ep. V

BASF, draisine KLV 53, livrée verte, ép. V

BASF, dresina KLV 53, decoración verde, ép. V

BASF, maintenance vehicle type KLV 53, green livery, period V



© Jörg Van Essen







HR2970/HR2970D



DB AG

**NEW**

**DB AG, automotore da manovra ASF 383 001-5, livrea verde, ep. V**

DB AG, ASF (Akku-Schleppfahrzeug) 383 001-5, grüne Farbgebung, Ep. V

DB AG, locomotive de manœuvre ASF 383 001-5, livrée verte, ép. V

DB AG, vehículo de maniobras ASF 383 001-5, decoración verde, ép. V

DB AG, ASF shunting device 383 001-5, green livery, ep. V



HR2971/HR2971D



DB AG

**NEW**

**DB AG, set di 2 automotori da manovra ASF "DB Cargo Gießen", livrea rossa e blu con luci lampeggianti, ep. V-VI**

DB AG, 2-tlg. Set ASF (Akku-Schleppfahrzeuge) „DB Regio Gießen“ in roter und blauer Farbgebung mit Blinklichtern, Ep. V-VI

DB AG, coffret de 2 locomotive de manœuvre ASF « DB Cargo Gießen », livrée rouge et bleue avec feux clignotants, ép. V-VI

DB AG, set de dos vehículos de maniobras ASF "DB Cargo Gießen", decoración rojo y azul, con luces de señalización, ép. V-VI

DB AG, 2-unit pack ASF shunting devices "DB Cargo Gießen", in red and blue livery with flashing lights, ep. V-VI



Con luce lampeggianti  
Mit Blinklicht aus dem Dach  
Avec feu clignotans  
Con luz de señalización  
With flashing light on the roof





# E.656

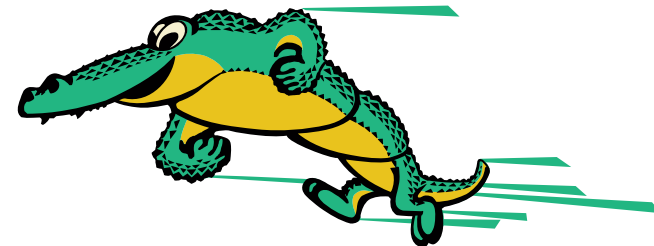

Photo: Maurizio Messa 



# Locomotiva Elettrica E.656

## Locomotiva E.656

Le locomotive elettriche del gruppo E.656 rappresentano l'ultima evoluzione della grande famiglia di locomotive "articolate" delle FS, caratterizzate dallo schema meccanico a due semicasce poggianti su tre carrelli a due assi dotati ciascuno di due motori (doppi in questo caso), introdotto con le E636 nel 1940 e mantenuto fino alla produzione dell'ultima E656 nel 1989.

Le E656 sono state consegnate a partire dal 1975 per un totale di 461 unità, suddivise in sei serie con alcune differenze tecniche ed estetiche frutto dell'evoluzione del progetto durante la costruzione. Grazie alla loro elevata potenza (continuitiva 4200 kW, oraria 4800 kW) e alla velocità massima di 150 km/h, furono da subito destinate a rilevare i treni passeggeri a lunga percorrenza più importanti dell'epoca, treni di prestigio come alcuni TEE, ma anche treni diretti o locali con numerose fermate fino a pesanti merci al limite delle prestazioni, diventando rapidamente una delle colonne portanti del parco trazione FS.

Nel 1976 sulla rivista "Voci della Rotaia" è stato indetto un concorso per scegliere un soprannome alla E656, come già avvenuto per la E444 "Tartaruga" qualche anno prima, e la proposta vincente è risultata "Caimano". A seguito di questo, sulla fiancata sinistra delle cabine è stato applicato un adesivo raffigurante una caricatura dell'animale.

Tutte le E656 sono state consegnate nella classica livrea grigio perla e blu orientale, con fascia rosso segnale su panconi e fanali, fregio FS a "telesivore" sul frontale con "baffi" gialli attorno a questo, ma inizialmente si era pensato ad uno schema di colorazione che riprendeva la livrea delle carrozze TEE con fasce rosse su fondo beige, applicata temporaneamente in fase di costruzione alla prima unità ma non completata. A fine anni '90, come tutto il materiale rotabile FS, è stata introdotta la livrea XMPR grigio chiaro/verde con fascia blu, che su queste macchine risultava abbastanza simile alla livrea di origine seppur con colori diversi.

Con la divisionalizzazione delle FS negli anni 2000 tutte le unità sono state ripartite tra Passeggeri, Regionale e Cargo, ed a partire dal 2002 le unità di quest'ultima divisione, destinate al servizio merci, hanno ricevuto un rapporto di trasmissione più corto per incrementare le prestazioni, riducendo la velocità massima a 120 km/h; le unità così trasformate sono state inquadrate nel gruppo E655.

A partire dal 2010 sono iniziati gli accantonamenti e demolizioni, divenuti sempre più frequenti negli anni successivi, fino alla graduale dismissione dal servizio regolare dell'intero gruppo. Attualmente, grazie al lavoro di Fondazione FS, almeno 18 unità sono state preservate dalla demolizione e molte di queste, dopo ripristino funzionale ed estetico in livrea di origine, sono utilizzate regolarmente in testa a treni storici.

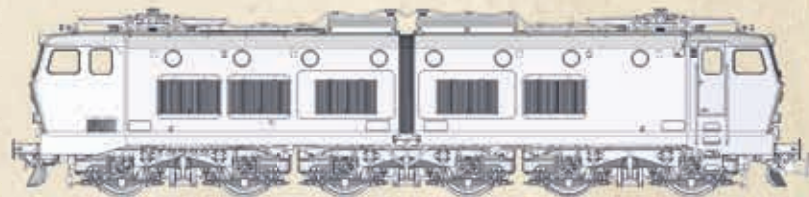

HR2965

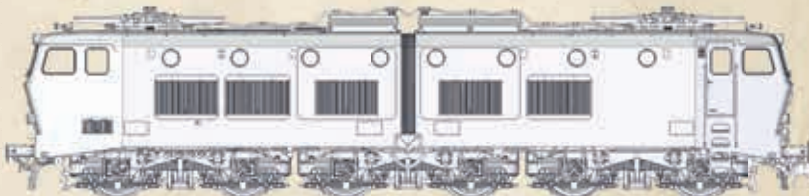

HR2966

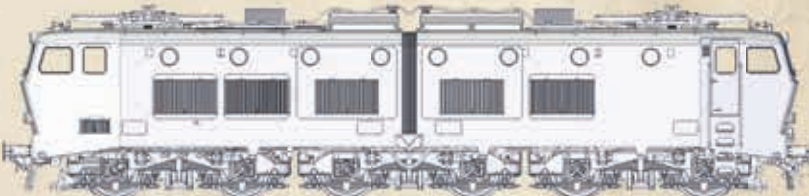

HR2967

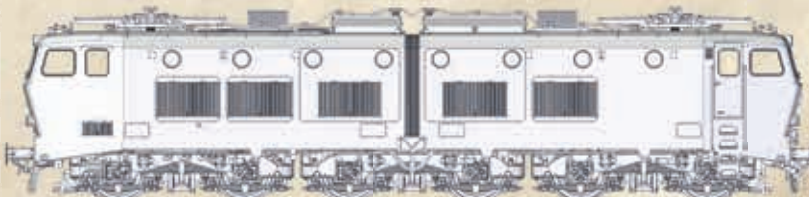

HR2968

E.656.001 - 104

2 motoalternatori.

E.656.201 - 251

Telaio irrobustito; 1 convertitore da 180 kVA 450 V 60 Hz CA.

E.656.252 - 307

Telaio irrobustito; 2 motoalternatori.

E.656.159 - 200

Telaio irrobustito; fanali maggiorati; 1 convertitore da 180 kVA 450 V 60 Hz CA, riadattato per l'interoperabilità su linee francesi (1,5 kV CC).

E.656.401 - 550

Telaio irrobustito; fanali maggiorati; 2 convertitori ARSA da 120kVA; sabbie ridotte; vetri anteriori modificati con cornice in gomma al posto del telsio in alluminio.

E.656.551 - 608

Telaio e cabina irrobustiti; fanali maggiorati; 2 convertitori ARSA da 120 kVA; sabbie ridotte ai soli assi anteriori; vetri anteriori modificati con cornice in gomma; respingenti piani con piatti rettangolari carrelli con ammortizzatori antispergoglio; asole specifiche per sollevamento in officina con cavalletti elettrici; centralina elettronica ridondata a microprocessore "Delfina" e sistema di telecomando a 78 poli con supporto per doppia trazione con una unità della stessa serie.

Serie FS	Serie	Locomotive	Anni di costruzione
I	1	E.656.001 - 104	1975 - 1979
	2	E.656.201 - 251	1978 - 1980
	3	E.656.252 - 307	1977 - 1980
	4	E.656.159 - 200	1981 - 1983
II	5	E.656.401 - 550	1984 - 1987
III	6	E.656.551 - 608	1988 - 1989

### Dati tecnici

Anni di progettazione	1973-1975
Anni di costruzione	1975-1989
Anni di esercizio	Dal 1975
Quantità prodotta	461
Costruttore	Officine Casaralta, Officine Meccaniche Reggiane, SOFER, TIBB Componentistica Ercole Marelli, Ansaldo, Asgen, Italtrafo, Officine Casertane.
Lunghezza	18290 mm
Larghezza	3000 mm
Altezza	3800 mm
Interperno	5200 mm
Passo dei carrelli	2850 mm
Massa in servizio	120 t
Rodiggio	Bo'Bo'Bo'
Diametro ruote motrici	1250 mm
Rapporto di trasmissione	E.656: 28/61 E.655: 23/66.
Potenza oraria	(su 12 motori) 4800 kW
Potenza continuitiva	4200 kW
Sforzo trazione massimo	Prototipi: 249 kN
Velocità massima omologata	E.656: 160 km/h limitata a 150 km/h E.655: 120 km/h
Alimentazione	3000 V =, 1500 V =

 **Rivarossi**



**HR2965/HR2965S****FS****NEW****FS, locomotiva elettrica E.656, 1a serie, livrea sperimentale TEE, ep. IV**

FS, schwere sechssachsige Elektrolokomotive der Reihe E.656, 1. Serie in experimenteller TEE-Farbgebung, Ep. IV

FS, locomotive électrique E.656, 1<sup>ère</sup> série, livrée expérimentale TEE, ép. IV

FS, locomotora eléctrica E.656, primera serie, decoración "TEE" experimental, ép. IV

FS, six-axle electric locomotive E.656, 1<sup>st</sup> series in experimental TEE livery, ep. IV**E.656**

- Nuovi stampi per cassa, carrelli e relative parti riportate, con riproduzione accurata di tutte le caratteristiche tipiche delle diverse serie costruttive su frontali, fiancate e tetto.
- Affidabile meccanica con telaio articolato e scatole ingranaggi in metallo, potente motore centrale a 5 poli con trasmissione a doppio albero cardanico su entrambi gli assi dei carrelli di estremità, due ruote con anello di aderenza.
- Impianto elettrico interamente nuovo, con presa 21 poli NEM 660/21MTC per decoder DCC e DCC Sound, con predisposizione per altoparlante "sugar cube" 11 x 15 mm.
- Versioni "S" con decoder sonoro Hornby HM7000 ed altoparlante installati di serie, con suoni specifici per il modello.
- Luci bianche di testa e rosse di coda con commutazione automatica in base al senso di marcia e con possibilità di esclusione indipendente tra le due cabine. Posizione dei fanali rossi coerentemente differenziata in base all'unità riprodotta.
- Terzo faro con comando indipendente dai fanali bassi.
- Illuminazione interna di entrambe le cabine e del corridoio laterale con comando indipendente.
- Possibilità di installazione del pattino centrale per funzionamento su sistemi a 3 rotaie, con commutazione del sistema tramite jumper sul circuito stampato.

**HM DCC**Fotomontage / Fotomontaje / Photomontage / Fotomontaggio  
L'immagine mostra il modello in scala N / Abb. zeigt Spur-N-Modell / Picture shows N-scale model**HR2966 /HR2966S****FS****NEW****FS, locomotiva elettrica E.656, 2a serie, livrea di origine, con gocciolatoio, ep. IV**

FS, schwere sechssachsige Elektrolokomotive der Reihe E.656, 2. Serie in Originalfarbgebung, mit Regenrinne, Ep. IV

FS, locomotive électrique E.656, 2<sup>e</sup> série, livrée d'origine, avec gouttière, ép. IV

FS, locomotora eléctrica E.656, segunda serie, con vierteaguas, decoración original 2, ép. IV

FS, six-axle electric locomotive E.656, 2nd series original livery, with gutter, ep. IV

**E.656**

- Portagancio NEM 362 con timone di allontanamento per aggancio corto su entrambe le testate, con possibilità di smontaggio del portagancio per allestire i frontali con tutti i particolari realistici.
- Riproduzione accurata dei pantografi Tipo 52 FS interamente in metallo con possibilità di captazione di corrente; posizione di riposo estremamente piatta e realistica.
- Riproduzione accurata del tetto con numerose parti riportate, griglie dei praticabili in fotoincisione conformi al vero, condizionatori completi di tubazioni dove presenti.
- Interni cabina e parete corridoio fedelmente riprodotti, con parti riportate e decorazioni differenziate tra cabine A e B come al vero.
- Carrelli Um1250 estremamente realistici, con sospensione secondaria e trave oscillante come pezzi riportati; con o senza riproduzione degli smorzatori antiserpeggio e con 4 o 12 sabbie, a seconda del periodo di ambientazione; riproduzione dei captatori della Ripetizione Segnali in cabina con boe SCMT dove presenti.
- Numerosi particolari riportati in metallo o plastica per il massimo realismo.

**HM DCC**Fotomontage / Fotomontaje / Photomontage / Fotomontaggio  
L'immagine mostra il modello in scala N / Abb. zeigt Spur-N-Modell / Picture shows N-scale model





HR2967/HR2967S



FS

**NEW**

**FS, locomotiva elettrica E.655, 2a serie, livrea XMPR, ep. V-VI**

FS, schwere sechssachsige Elektrolokomotive der Reihe E.655, 2. Serie in XMPR-Farbgebung, Ep. V-VI

FS, locomotive électrique E.655, 2<sup>ème</sup> série, livrée XMPR, ép. V-VI

FS, locomotora eléctrica E.655, segunda serie, decoración "XMPR", ép. V-VI

FS, six-axle electric locomotive E.655, 2nd series XMPR livery, ep. V-VI



Fotomontage / Fotomontaje / Photomontage / Fotomontaggio  
L'immagine mostra il modello in scala N / Abb. zeigt Spur-N-Modell / Picture shows N-scale model



HR2968/HR2968S



FS

**NEW**

**FS, locomotiva elettrica E.656, 4a serie, livrea di origine, senza gocciolatoio, con smorzatori, ep. V**

FS, schwere sechssachsige Elektrolokomotive der Reihe E.656, 4. Serie in OriginalFarbgebung, ohne Regenrinne, mit Dämpfern, Ep. V

FS, locomotive électrique E.656, 4<sup>ème</sup> série, livrée d'origine, sans gouttière et avec ventilateurs, ép. V

FS, locomotora eléctrica E.656, cuarta serie, sin vierteaguas y con amortiguadores, decoración original, ép. V

FS, six-axle electric locomotive E.656, 4th series original livery, without gutter, with dampers, ep. V



Fotomontage / Fotomontaje / Photomontage / Fotomontaggio  
L'immagine mostra il modello in scala N / Abb. zeigt Spur-N-Modell / Picture shows N-scale model

# E.645



© Donato Rossi

### Il nuovissimo modello Rivarossi nei punti chiave:

- Nuovi stampi per le carrozzerie, con riproduzione accurata di tutte le caratteristiche tipiche delle macchine di prima serie nell'ambientazione da fine anni '80, con modifiche ai gocciolatoi delle cabine, pannelli laterali, fregio FS frontale in diverse posizioni a seconda dell'unità riprodotta, serpentina sul ricasco del tetto, scalette e corrimani coerenti con l'epoca
- Collaudata ed affidabile meccanica con telaio articolato e scatole ingranaggi in metallo, potente motore centrale a 5 poli con trasmissione a doppio albero cardanico su entrambi gli assi dei carrelli di estremità, due ruote con anello di aderenza
- Nuovo impianto elettrico con presa 21 poli NEM 660/21MTC per decoder DCC e DCC Sound, con predisposizione per altoparlante circolare da 23 mm oppure di tipo "sugar cube" da 11x15 mm
- Versioni "S" con decoder sonoro ESU Loksound V5 ed altoparlante installati di serie, con suoni specifici per il modello
- Luci bianche di testa e rosse di coda con commutazione automatica in base al senso di marcia e con possibilità di esclusione indipendente tra le due cabine, sia in analogico (tramite DIP SWITCH sulla PCB principale) che in digitale (tramite decoder)
- Possibilità di installazione del pattino centrale per funzionamento su sistemi a 3 rotaie, con commutazione del sistema tramite jumper sul circuito stampato
- Portagancio NEM 362 con timone di allontanamento per aggancio corto su entrambe le testate, con possibilità di smontaggio del portagancio per allestire i frontali con tutti i particolari realistici
- Riproduzione accurata dei pantografi Tipo 52 o 42U FS (a seconda dell'unità riprodotta) interamente in metallo con possibilità di captazione di corrente; posizione di riposo estremamente piatta e realistica
- Carrelli U1250 con 4 o 12 sabbie, a seconda del periodo di ambientazione; riproduzione dei cacciapietre di origine oppure dotati di captatori della Ripetizione Segnali, a seconda della versione riprodotta
- Numerosi particolari riportati in metallo o plastica per il massimo realismo, tra cui nuovi supporti reggibattenti sui panconi in fotoincisione installati in fabbrica



HR2934/HR2934S



### FS, locomotiva elettrica E.645, 1a serie, livrea castano/Isabella con logo FS semplificato, pantografi 42U, ep. IV-V

FS, Elektrolokomotive E.645, 1. Serie, castano/Isabella-Lackierung mit vereinfachtem FS-Logo, Stromabnehmer 42U, ep. IV-V

FS, locomotive électrique E.645, 1<sup>ère</sup> série, livrée castano/Isabella avec logo FS simplifié, pantographes 42U, ép. IV-V

FS, locomotora eléctrica E.645, primera serie, decoración castano/Isabella con logo FS simplificado, pantógrafos 42U, ép. IV-V

FS, electric locomotive E.645, 1st series, castano/Isabella livery with simplified FS logo, pantographs 42U, period IV-V



- Livrea castano/isabella con carrelli neri
- Fregio FS a scudo senza baffi in posizione alta, con sfondo castano
- Cabine con gocciolatoio lato macchinista ridotto e senza gocciolatoio frontale
- Epoca IVb-Va (fine anni '80/inizio '90)
- 12 sabbie sui carrelli
- Serpentina su ricasco tetto semicassa B
- Cacciapietre con captatori della Ripetizione Segnali
- Pantografi Tipo 42U FS con strisciante curvo
- Vomeri a lame curve con strisce gialle/neri

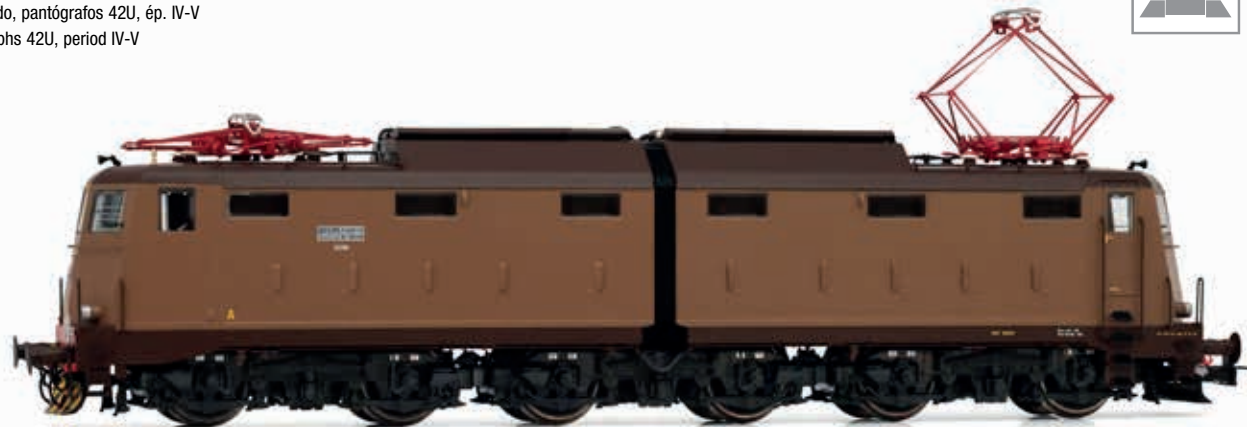



**HR2935/HR2935S****FS****FS, locomotiva elettrica E.645, 1a serie, livrea Isabella con logo FS rosso semplificato, pantografi 52, ep. V**

FS, Elektrolokomotive E.645, 1. Serie, Isabella-Lackierung mit vereinfachtem FS-Logo, Stromabnehmer 52, ep. V

FS, locomotive électrique E.645, 1<sup>ère</sup> série, livrée Isabella avec logo rouge simplifié FS, pantographe 52, ep. V

FS, locomotora eléctrica E.645, primera serie, decoración Isabella con logo FS rojo simplificado, pantógrafos 52, ép. V

FS, electric locomotive E.645, 1st series, Isabella livery with simplified red FS logo, pantographs 52, period V



- Livrea isabella con carrelli neri
- Fregio FS a scudo senza baffi in posizione bassa, con sfondo rosso
- Cabine con gocciolatoio lato macchinista ridotto e senza gocciolatoio frontale
- Epoca V (anni '90/2000)
- 4 sabbie sui carrelli
- Serpentina su ricasco tetto semicassa B
- Sportellino dispositivo "Willy Vogel" su semicassa B
- Cacciapietre con captatori della Ripetizione Segnali
- Pantografi Tipo 52 FS con strisciante piano
- Vomeri a lame curve con strisce gialle/neri

**HR2933/HR2933S****FS****FS, locomotiva elettrica E.645, 1a serie, livrea castano/Isabella con logo FS semplificato, pantografi 52, ep. IV-V**

FS, Elektrolokomotive E.645, 1. Serie, castano/Isabella-Lackierung mit vereinfachtem FS-Logo, Stromabnehmer 52, Ep. IV-V

FS, locomotive électrique E.645, 1<sup>ère</sup> série, livrée castano/Isabella avec logo FS simplifié, pantographes 52, ép. IV-V

FS, locomotora eléctrica E.645, primera serie, decoración castano/Isabella con logo FS simplificado, pantógrafos 52, ép. IV-V

FS, electric locomotive E.645, 1st series, castano/Isabella livery with simplified FS logo, pantographs 52, period IV-V



- Livrea castano/isabella con carrelli neri
- Fregio FS a scudo senza baffi in posizione alta, con sfondo castano
- Cabine con gocciolatoio lato macchinista ridotto e senza gocciolatoio frontale
- Epoca IVb-Va (fine anni '80/inizio '90)
- 12 sabbie sui carrelli
- Serpentina su ricasco tetto semicassa B
- Cacciapietre di origine
- Pantografi Tipo 52 FS con strisciante curvo
- Vomeri a lame curve con strisce gialle/neri







# E.636

## Locomotiva E.636

Nel 1938 l'ingegner Alfredo d'Arbela e la sua équipe presentarono un nuovo tipo di rotabile. La costruzione della prima serie di dieci unità, numerate E.636.001-010, fu ordinata il 1° settembre 1938 e le macchine furono consegnate tra il maggio ed il settembre 1940.

Le nasciture E.636 concettualmente erano nient'altro che una versione meccanicamente aggiornata delle vecchie E.626, e ne mantenevano alcuni problemi di progettazione: qualche problema di rumorosità causato dal sistema di trasmissione non impedì a questo nuovo gruppo di affermarsi. Vennero studiati due diversi rapporti di trasmissione: uno più corto (21/65) per i tratti in pendenza o per i treni pesanti, con velocità massima di 95 km/h (poi accresciuta a 105 nel 1948) ed uno più lungo (28/65) con velocità massima di 120 km/h.

Il primo esemplare, la E.636.001, entrò in servizio nel maggio 1940, e durante la guerra altre 107 unità furono consegnate fino al 1943 da diverse industrie quali Breda, OM, CGE, Officine Meccaniche Reggiane, Magneti Marelli e Officine Ferroviarie Savigliano. Il gruppo E.636 è stato prodotto in tre serie di locomotive. La prima serie (001 - 108) costruita dal 1940 al 1942. La seconda serie (109 - 243) costruita dal 1952 al 1956. E la terza serie (244 - 469), costruita dal 1957 al 1962.





HR2936/HR2936S



**FS, locomotiva elettrica E.636, 3a serie, senza gocciolatoi frontali, livrea castano/Isabella, ep. IV-V**

FS, Elektrolokomotive E.636, 3. Bauserie ohne Regenrinnen in brauner Castano/Isabella-Lackierung, Ep. IV-V

FS, locomotive électrique E.636, 3ème série, livrée castano/Isabella, sans gouttières, ép. IV-V

FS, locomotora eléctrica E.636, tercera serie, sin vierteaguas, decoración castano/Isabella, ép. IV-V

FS, electric locomotive E.636, 3rd series, without gutters, castano/Isabella livery, period IV-V



HR2937/HR2937S



**FS, locomotiva elettrica E.636, 3a serie, senza gocciolatoi frontali, livrea Isabella, ep. V**

FS, Elektrolokomotive E.636, 3. Bauserie ohne Regenrinnen in Isabella-Lackierung, Ep. V

FS, locomotive électrique E.636, 3ème série, livrée Isabella, sans gouttières, ép. V

FS, locomotora eléctrica E.636, tercera serie, sin vierteaguas, decoración Isabella, ép. V

FS, electric locomotive E.636, 3rd series, without gutters, Isabella livery, period V





HR2941/HR2941S



**NEW**

**DR, locomotiva elettrica E251 001, livrea verde con carrelli neri, ep. III**

DR, schwere sechssachsige Elektrolokomotive E251 001 in grüner Farbgebung mit schwarzen Drehgestellen, Ep. III

DR, locomotive électrique E251 001, livrée verte avec bogies noirs, ép. III

DR, locomotora eléctrica E251 001, decoración verde con bogies negros, ép. III

DR, six-axle electric locomotive E251 001, green livery with black bogies, ep. III



HR2942/HR2942S



**NEW**

**DR, locomotiva elettrica 251 015-4, livrea verde con carrelli rossi, ep. IV**

DR, schwere sechssachsige Elektrolokomotive 251 015-4 in grüner Farbgebung mit roten Drehgestellen, Ep. IV

DR, locomotive électrique 251 015-4, livrée verte avec bogies rouges, ép. IV

DR, locomotora eléctrica 251 015-4, decoración verde con bogies rojos, ép. IV

DR, six-axle electric locomotive 251 015-4, green livery with red bogies, ep. IV







HR2961/HR2961S



DB AG

**NEW**

### DB AG, locomotiva elettrica, BR 171, livrea rosso traffico, ep. V

DB AG, schwere sechssachsige Elektrolokomotive der Baureihe 171 in verkehrsroter Farbgebung, Ep. V

DB AG, locomotive électrique, BR 171, livrée rouge trafic, ép. V

DB AG, locomotora eléctrica BR 171, decoración rojo tráfico, ép. V

DB AG, heavy six-axle electric locomotive, BR 171, traffic red livery, ep. V



### Das neue Rivarossi-Modell im Detail

- Chassis aus Metalldruckguss
- Kurzkupplungskinematik
- 21-polige Digitalchnittstelle (MTC)
- mittlere Achse im Drehgestell federnd gelagert
- 4 Haftreifen für maximale Zugkraft
- 2 Schwungmassen
- funktionsfähige Stromabnehmer
- Zurüstteile für den Einsatz als Vitrinenmodell
- Dreilicht-Spitzensignal und rotes Schlusslicht mit der Fahrtrichtung wechselnd, Rangierlicht im Digitalbetrieb schaltbar
- Vorbereitet für den Einbau eines Sound-Decoders
- Individuelle Nachbildung der Dachlaufstege (Holz bzw. Metall)
- Individuelle Nachbildung der Signalhörner (verschiedene Bauarten)
- Individuelle Nachbildung der Bremslüfter, je nach Loknummer und Bauzustand
- Individuelle Nachbildung der Sifa, je nach Loknummer und Bauzustand



© Roland Lange



HR2938/HR2938S



ÖBB

**ÖBB, locomotiva elettrica 1040 003, livrea rosso vermiglio con una fascia decorativa, ventola di origine, tetto basso, predellini frontali, ep. V**

ÖBB, Elektrolokomotive 1040 003, blutorange Lackierung mit Zierlinie, Ursprungslüfter, Flachdach, Trittstufen, Ep. V

ÖBB, locomotive électrique 1040 003, livrée rouge vermillon avec une bande décorative, ventilateur d'origine, toit bas et marchepieds avant, ép. V

ÖBB, locomotora eléctrica 1040 003, decoración rojo bermellón con franja, ventilador de origen, techo bajo y estribos frontales, ép. V

ÖBB, electric locomotive 1040 003, vermillion livery with one decoration line, old fan, low roof, steps on front, ep. V







HR2939/HR2939S



ÖBB

**ÖBB, locomotiva elettrica 1040.10, nuove griglie di ventilazione laterali, livrea verde, con reostato di frenatura sul tetto, ep. IV**

ÖBB, Elektrolokomotive 1040.10, neue seitliche Lüftungsgitter, grüne Lackierung, mit Bremswiderständen auf dem Dach, Ep. IV

ÖBB, locomotive électrique 1040.10, livrée verte avec grilles de ventilation modernes et équipement de freinage rhéostatique sur le toit, ép. IV

ÖBB, locomotora eléctrica 1040.10, decoración verde con rejillas de ventilación modernas y freno reostático en el techo, ép. IV

ÖBB, electric locomotive 1040.10, new lateral air vents, green livery, with brake resistors on the roof, ep. IV



HR2940/HR2940S



ÖBB

**ÖBB, locomotiva elettrica 1040 007-5, nuove griglie di ventilazione laterali, livrea rosso vermiglio con tre fasce decorative, tetto basso, predellini frontali, ep. V**

ÖBB, Elektrolokomotive 1040 007-5, neue seitliche Lüftungsgitter, blutorange Lackierung mit drei Zierlinien, niedriges Dach, Rangiertritte vorn und hinten, Ep. V

ÖBB, locomotive électrique 1040 007-5, livrée rouge vermillon avec trois bandes décoratives, grilles de ventilation modernes, toit bas et marchepieds avant, ép. V

ÖBB, locomotora eléctrica 1040 007-5, decoración rojo bermellón con tres franjas, con rejillas de ventilación laterales modernas, techo bajo y estribos frontales, ép. V

ÖBB, electric locomotive 1040 007-5, new lateral air vents, vermillion livery with three decoration lines, low roof, steps on front, ep. V



# 60 Jahre Re 4/4<sup>II</sup> der BLS

GIPFELSTÜMER



Photo: Staatarchiv des Kantons Bern



Anlässlich des 60. Jubiläums wird dieses Modell in einer attraktiven Sonderverpackung geliefert.

## Der elektrische Universallokomotive der ehemaligen Bern-Lötschberg-Simplon-Bahn

Die BLS Ae 4/4II wurde von 1964 bis 1983 als Universallokomotive mit guter Bergleistung beschafft, um die Züge mit höheren Geschwindigkeiten befördern zu können und um die Lokomotiven der Gründungsjahre abzulösen.

Aufgrund der sehr erfolgreichen Konstruktion der Ae 4/4 der BLS, der ersten laufachslosen Hochleistungslokomotive der Welt, leiteten die BLS und SLM die Neuentwicklung von dieser Reihe ab. Das ist auch an der Kastenform eindeutig zu erkennen: Die Anordnung der Einstiege an der Lokfront wurde von der Ae 4/4 übernommen. Das Fahrgestell ist ähnlich demjenigen der SBB Re 4/4II. Doch da hören die Gemeinsamkeiten zu dieser auch sehr erfolgreichen Baureihe auf. So wird die Kraft mit einer anders konstruierten Tiefzuganlenkung und Seilzug auf die Schienen gebracht. Statt Sandereinrichtungen besitzt die Lok Schienendüsen. Bei vielen Versuchen und Vergleichen mit z. T. ausländischen Lokomotiven stellt die Re 4/4 noch heute ihre enorme Leistungsfähigkeit am Berg unter Beweis. Einen 630-Tonnen-Zug kann die Lok auf einer 26-‰-Steigung mit 80 km/h befördern. Die Stundenzugkraft beträgt 226 kN bei 77,5 km/h.

Die ersten fünf Maschinen waren bei Ablieferung nur für 125 km/h zugelassen und wurden dementsprechend Ae 4/4II 261–265 bezeichnet. 1969 wurden sie nach Änderung der Kastenabstützung auf Schraubenfedern und ausgedehnten Versuchsfahrten für die Reihe R zugelassen und die Höchstgeschwindigkeit auf 140 km/h hinaufgesetzt. Seither tragen die Lokomotiven die Bezeichnung Re 4/4 161–165.

HR2958/HR2958S/HR2958ACS



BLS

NEW

## BLS, locomotiva elettrica a 4 assi Re 4/4 167 "Ausserberg", livrea marrone, ep. IV-V

BLS, vierachsige elektrische Mehrzwecklokomotive Re 4/4 167 „Ausserberg“, braun, Ep. IV-V

BLS, locomotive électrique à 4 essieux Re 4/4 167 « Ausserberg », livrée marron, ép. IV-V

BLS, locomotora eléctrica Re 4/4 167 "Ausserberg" corta, edición aniversario BLS, ép. IV-V

BLS, 4-axle electric locomotive Re 4/4 167 "Ausserberg", brown, epoch IV-V



Fotomontage / Fotomontaje / Photomontage / Fotomontaggio







**HR2959/HR2959S/HR2959ACS**



**BLS**

**NEW**

**BLS, locomotiva elettrica a 4 assi Re 4/4 181 "Interlaken", livrea marrone, ep. IV**

BLS, vierachsige elektrische Mehrzwecklokomotive Re 4/4 181 „Interlaken“, braun, Ep. IV

BLS, locomotive électrique à 4 essieux Re 4/4 181 « Interlaken », livrée marron, ép. IV

BLS, locomotora eléctrica Re 4/4 181 "Interlaken" larga, ép. IV

BLS, 4-axle electric locomotive Re 4/4 181 "Interlaken », brown, epoch IV



*Fotomontage / Fotomontaje / Photomontage / Fotomontaggio*



**HR2960/HR2960S/HR2960ACS**



**BLS**

**NEW**

**BLS, locomotiva elettrica a 4 assi Re 4/4 191 "Reichenbach", con pantografo monobraccio, livrea marrone, ep. IV-V**

BLS, vierachsige elektrische Mehrzwecklokomotive Re 4/4 191 „Reichenbach“, mit Einholmstromabnehmer, braun, Ep. IV-V

BLS, locomotive électrique à 4 essieux Re 4/4 191 « Reichenbach », avec pantographe unijambiste, livrée marron, ép. IV-V

BLS, locomotora eléctrica Re 4/4 191 "Reichenbach" larga con pantógrafo de brazo, ép. IV-V

BLS, 4-axle electric locomotive Re 4/4 191 "Reichenbach », with single-arm pantograph, brown, epoch IV-V



*Fotomontage / Fotomontaje / Photomontage / Fotomontaggio*



HR2943/HR2943HM



**NEW**

**Tram DUEWAG GT8, versione Graz, livrea blu/beige, ep. IV-V**

Straßenbahn, Typ DUEWAG GT8, Version Graz in grün/beiger Lackierung, Ep. IV-V

Tram DUEWAG GT8, version Graz, livrée bleue/beige, ép. IV-V

Tranvia DUEWAG GT8, versión Graz, decoración azul/beige, ép. IV-V

DUEWAG tram GT8, Graz version, blue/beige livery, period IV-V



HR2944/HR2944HM



**NEW**

**Tram N8, versione Dortmund, livrea marrone/beige, ep. IV**

Straßenbahn, Typ N8, Version Dortmund in braun/beiger Lackierung, Ep. IV

Tram N8, version Dortmund, livrée marron/beige, ép. IV

Tranvia N8, versión Dortmund, decoración marrón/beige, ép. IV

Tram N8, Dortmund version, brown/beige livery, period IV







## HR2945/HR2945HM



# NEW

### Tram M6, versione Norimberga, livrea rossa/bianca, ep. IV-V

Straßenbahn, Typ M6, Version Nürnberg in rot/weißer Lackierung, Ep. IV-V

Tram M6, version Nuremberg, livrée rouge/blanche, ép. IV-V

Tranvia M6, versión Nüremberg, decoración roja/blanca, ép. IV-V

Tram M6, Nuremberg version, red/white livery, period IV-V

#### Die ersten Rivarossi-Modelle mit HM7000-Bluetooth®-Digitaldecodern

Die Digitalversionen unserer neuen Rivarossi-Straßenbahnmodelle HR2943HM, HR2944HM, HR2945HM und HR2861HM sind die ersten Rivarossi-Modelle, die mit den neuen Hornby HM7000 Bluetooth®-Decodern ausgestattet sind. Diese können über Ihr Smartphone oder Tablet gesteuert werden, ohne dass Sie dazu eine Digitalzentrale benötigen. Mehr über alle revolutionären Funktionen des neuen Systems erfahren Sie hier: <https://de.rivarossi.com/hm7000>



## HR2861/HR2861HM



### Tram DUEWAG GT6 Heidelberger, livrea "Coca Cola", ep. IV-V

Straßenbahn, Typ DUEWAG GT6, Version Heidelberger in „Coca Cola“-Lackierung, Ep. IV-V

Tram DUEWAG GT6 Heidelberger, livrée « Coca Cola », ép. IV-V

Tranvia DUEWAG GT6 Heidelberger, decoración «Coca Cola», ép. IV-V

DUEWAG tram GT6 Heidelberger, "Coca Cola" livery, period IV-V

#### First Rivarossi models with HM7000 Bluetooth® digital decoders

The digital versions of our new Rivarossi tram models HR2943HM, HR2944HM, HR2945HM and HR2861HM are the first Rivarossi models to come equipped with the new Hornby HM7000 Bluetooth® decoders that can be controlled via your smartphone or tablet without the need of a digital central. More about all the revolutionary features of new system here: <https://uk.rivarossi.com/hm7000>



Fotomontage / Fotomontaje / Photomontage / Fotomontaggio



# FS ETR 460



## ETR 460

Gli ETR.460 sono caratterizzati dagli attuatori dell'assetto variabile posti in posizione quasi orizzontale fra cassa e carrello, ottenendo quindi un minor ingombro di tali dispositivi rispetto a convogli del passato che li prevedevano in posizione verticale. Come gli ETR-450, inizialmente anche gli ETR-460 erano stati concepiti come treni di sola I classe, ma nell'estate 1993, quando era già iniziata la costruzione dei primi esemplari, le FS decisero di includere anche il servizio di II classe, rendendo quindi necessaria una parziale riprogettazione che portò a un ritardo nella consegna dei primi treni: il 12 Giugno 1994 il primo convoglio uscì dai cancelli della FIAT Ferroviaria nella composizione provvisoria di soli 6 elementi (due unità di trazione) di sola I classe, cosa che avvenne anche per i successivi due treni. Nel corso dei mesi seguenti le composizioni vennero poi riorganizzate e completate con tutti gli elementi di II classe e le carrozze Bar/Ristoro. Gli ETR-460 debuttarono in servizio nei primi mesi del 1995, assumendo quindi il ruolo di rotabili di punta delle FS; dapprima sostituirono gradualmente gli ETR-450 sulla relazione Milano-Roma, dopodiché, man mano che vennero completate le consegne di tutti e dieci i convogli (numerati da 21 a 30), vennero inseriti anche sulle relazioni tra Torino e Venezia e tra Torino, Genova e Roma. A partire dall'autunno 1996 tuttavia persero il primato sulla relazione Milano-Roma, venendo progressivamente sostituiti dai nuovi ETR-500 e venendo quindi dirottati su altre relazioni.





HR2962/HR2962S



FS

**NEW**

**FS, set di 4 unità, treno ad alta velocità ad assetto variabile ETR 460, livrea “Frecciabianca”, ep. VI**

FS, Hochgeschwindigkeitszug mit Neigetechnik der Reihe ETR 460 „Frecciabianca“, 4-tlg. Grundset, Ep. VI

FS, coffret de 4 unités de train pendulaire à grande vitesse ETR 460 « Frecciabianca », ép. VI

FS, automotor eléctrico ETR 460 “Frecciabianca”, set base de 4 unidades, ép. VI

FS, tilting high-speed train type ETR 460 “Frecciabianca”, 4-unit base set, ep. VI



HR3024



FS

**NEW**

**FS, set di 5 carrozze intermedie per il treno ad alta velocità ad assetto variabile ETR 460, livrea “Frecciabianca”, ep. VI**

FS, 5-tlg. Set Zwischenwagen für Hochgeschwindigkeitszug mit Neigetechnik der Reihe ETR 460 „Frecciabianca“, Ep. VI

FS, coffret de 5 voitures intermédiaires du train pendulaire à grande vitesse ETR 460 « Frecciabianca », ép. VI

FS, set de 5 coches intermedios del automotor ETR 460 “Frecciabianca”, ép. VI

FS, tilting high-speed train type ETR 460 “Frecciabianca”, 5-unit pack intermediate coaches, ep. VI



Archivio Rivarossi

**HR2963/HR2963S****Cisalpino****NEW****Cisalpino, set base di 4 unità, treno ad alta velocità ad assetto variabile ETR 470, livrea d'origine con fascia anteriore rossa, ep. V**

Cisalpino, Hochgeschwindigkeitszug mit Neigetechnik der Reihe ETR 470, 4-tlg. Grundset, Ep. V

Cisalpino, coffret de base de 4 unités, train pendulaire à grande vitesse ETR 470, livrée d'origine avec bande frontale rouge, ép. V

Cisalpino, automor eléctrico ETR 470, decoración original con franja roja frontal, set base de 4 unidades, ép. V

Cisalpino, tilting high-speed train type ETR 470 in original livery with red front stripe, 4-unit base set, ep. V

**HR3025****Cisalpino****NEW****Cisalpino, set di 5 carrozze intermedie per il treno ad alta velocità ad assetto variabile ETR 470, livrea originale, ep. V**

Cisalpino, 5-tlg. Set Zwischenwagen für Hochgeschwindigkeitszug mit Neigetechnik der Reihe ETR 470, Ep. V

Cisalpino, coffret de 5 voitures intermédiaires supplémentaires, train pendulaire à grande vitesse ETR 470, livrée d'origine, ép. V

Cisalpino, set de 5 coches intermedios del automotor ETR 470, decoración original, ép. V

Cisalpino, tilting high-speed train type ETR 470 in original livery, 5-unit pack additional intermediate coaches, ep. V



Enrique Dopico





HR2964/HR2964S



SBB CFF FFS

**NEW**

**FFS, set di 3 unità, treno ad alta velocità ad assetto variabile ETR 470, livrea argento con strisce blu, ep. V**

SBB, Hochgeschwindigkeitszug mit Neigetechnik der Reihe ETR 470, 4-tlg. Grundset, Ep. V

FFS, coffret de 3 unités, train pendulaire à grande vitesse ETR 470, livrée argentée avec bande bleue, ép. V

SBB, automotor eléctrico ETR 470, decoración plata con franja azul, set base de 4 unidades, ép. V

SBB, tilting high-speed train type ETR 470 silver livery with blue stripe, 4-unit base set, ep. V



HR3026



SBB CFF FFS

**NEW**

**FFS, set di 5 carrozze intermedie per il treno ad alta velocità ad assetto variabile ETR 470, livrea argento con striscia blu, ep. V**

SBB, 5-tlg. Set Zwischenwagen für Hochgeschwindigkeitszug mit Neigetechnik der Reihe ETR 470, Ep. V

FFS, coffret de 5 voitures intermédiaires supplémentaires pour le train pendulaire à grande vitesse ETR 470, livrée argentée avec bande bleue, ép. V

SBB, set de 5 coches intermedios del automotor ETR 470, decoración plata con franja azul, ép. V

SBB, tilting high-speed train type ETR 470 in silver livery with blue stripe, 5-unit pack additional intermediate coaches, ep. V



Enrique Dopico





# EDELWEISS PULLMAN EXPRESS

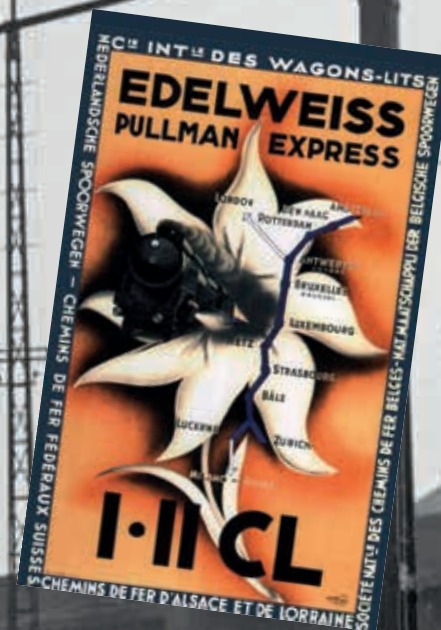

## Der Edelweiss Pullman Express

Der „Edelweiss“ verkehrte von 1928 bis 1979 mit kriegsbedingter Unterbrechung als Zugpaar zwischen der Schweiz und den Niederlanden über das Elsass und Luxemburg. Bis 1939 verkehrte der Zug als von der Internationalen Schlafwagengesellschaft CIWL betriebener Luxuszug von Amsterdam nach Basel und zweitweise auch Luzern. Nach dem Zweiten Weltkrieg zunächst als normaler Schnellzug geführt, wurde der Edelweiss ab 1957 eines der ersten Zugpaare des neuen Trans-Europ-Express-Systems (TEE). 1979 wurde er eingestellt.

Wenig bekannt ist, dass der Edelweiss Pullman Express der CIWL damals ein direkter Konkurrent des damaligen Rheingolds war. Bis zum Kriegsausbruch verkehrte der Zug südlich von Basel aber auch zusammen mit den Kurswagen des Rheingolds.

Die CIWL setzte im „Edelweiss“ bis 1939 als Fahrzeuge ausschließlich ihre ab 1925 beschafften Pullmanwagen ein. Da diese mit Küche und Am-Platz-Service ausgestattet waren, gab es in der Regel keinen gesonderten Speisewagen und darüber hinaus nur Gepäckwagen. Als Tageszug führte der Edelweiss keine Schlafwagen mit. Im Regelfall bestand der „Edelweiss“ aus mindestens vier Pullmanwagen sowie zwei Gepäckwagen.

Pullman-Edelweiss-Zug Bahnhof Basel. 1937.  
© Wagons-Lits Diffusion





HR4390



CIWL

**NEW**

**CIWL, set di 3 unità "Edelweiss Pullman Express", set 1/2 (DD3, VPC Côte d'Azur + VP Étoile du Nord), ep. II**

CIWL, 3-tlg. Zugset „Edelweiss Pullman Express“, Set 1/2 (DD3, VPC Côte d’Azur + VP Étoile du Nord), Ep. II

CIWL, coffret de 3 unités « Edelweiss Pullman Express », set 1/2 (DD3, VPC Côte d’Azur + VP Étoile du Nord), ép. II

CIWL, primer set de 3 coches "Edelweiss Pullman Express", compuesto de un coche DD3, un VPC "Côte d'Azur" y un VP "Étoile du Nord", ép. II

CIWL, 3-unit pack "Edelweiss Pullman Express", train set 1/2 (DD3, VPC Côte d'Azur + VP Étoile du Nord), ep. II

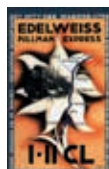

**Vetture dotate di illuminazione interna con touch control per attivare e variare l'intensità**

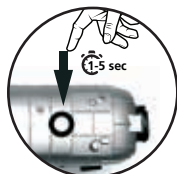

HR4391



CIWL

**NEW**

**CIWL, set di 3 unità "Edelweiss Pullman Express", set 2/2 (DD3, VPC Flèche d'Or + VP Étoile du Nord), ep. II**

CIWL, 3-tlg. Zugset „Edelweiss Pullman Express“, Set 2/2 (DD3, VPC Flèche d’Or + VP Étoile du Nord), Ep. II

CIWL, coffret de 3 unités « Edelweiss Pullman Express », set 2/2 (DD3, VPC Flèche d’Or + VP Étoile du Nord), ép. II

CIWL, segundo set de 3 coches "Edelweiss Pullman Express", compuesto de un coche DD3, un VPC "Flèche d'Or" y un VP "Étoile du Nord", ép. II

CIWL, 3-unit pack "Edelweiss Pullman Express", train set 2/2 (DD3, VPC Flèche d'Or + VP Étoile du Nord), ep. II

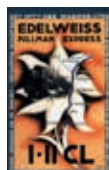

**Vetture dotate di illuminazione interna con touch control per attivare e variare l'intensità**

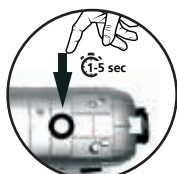



HR4360

IV

873

L

K

←

FS

**NEW**

**FS, set di 3 carrozze "Rapido 904-905", composto da 1 ristorante CIWL 1925T "Pistoiesi", 1 UIC-X '68 di 1a cl. e 1 UIC-X '68 di 2a cl. livrea grigia, fasciar rossa, ep. IV**

FS, 3-tlg. Set Reisezugwagen „Rapido 904-905“, bestehend aus 1 x CIWL Speisewagen 1925T, 1 x 1.Kl. Wagen UIC-X '68 und 1 x 2.Kl. Wagen in grauer Farbgebung mit rotem Streifen, Ep. IV

FS, coffret de 3 voitures Rapido 904-905, composé de 1 voiture-restaurant CIWL WR 1925T, 1 voiture de 1ère classe UIC-X '68 et 1 voiture de 2ème classe en livrée grise avec bande rouge, ép. IV

FS, set de 3 coches "Rapido 904-905", compuesto de un coche restaurante CIWL WR 1925T, uno de primera clase UIC-X '68 y uno segunda en decoración gris con franja roja, ép. IV

FS, 3-unit pack of coaches "Rapido 904-905" including 1 CIWL restaurant coach WR 1925T, 1 x 1st class coach UIC-X '68 and 1 x 2nd class coach in grey livery with red stripe, ep. IV



Assi sostitutivi per corrente alternata: HC6102 (10.50 x 24.50 mm)



### Dettagli modello

#### Carrozza ristorante WR 1925T "Pistoiesi" ex CIWL

- Nuovi stampi per cassa, vetri e telaio della ristorante WR 1925T "Pistoiesi", tipologia di carrozza mai prodotta in precedenza da Rivarossi.
- Riproduzione dettagliata delle nuove apparecchiature sottocassa, del tetto, delle testate ricostruite e dei dettagli sulle fiancate.
- Interni coerentemente modificati.
- Versione con testate ricostruite ed intercomunicanti tubolari.
- Carrelli M4p.
- Livrea CIWL con emblema a centro cassa e fascia rossa "alta velocità" indicante l'abilitazione ai 180 km/h.
- Cinematismo di aggancio corto a norma NEM 362.
- Targhe di percorrenza specifiche in fotoincisione fornite in bustina

#### Carrozze UIC-X

- Carrozze tipo 1968 con carrelli MDfd di 1ª o 2ª classe.
- Livrea grigio ardesia con fascia rossa "alta velocità" indicante l'abilitazione ai 180 km/h.
- Nuovi predellini sulle porte di salita.
- Nuova riproduzione dei freni a disco sui carrelli.
- Numerazioni inedite.
- Cinematismo di aggancio corto a norma NEM 362.
- Targhe di percorrenza specifiche in fotoincisione fornite in bustina.



**HR4361**

IV

**FS****NEW****FS, set di 3 carrozze "Alpen-Express", composto da 1 ristorante ex CIWL 1925T "Pistoiesi", 1 UIC-X di 1a cl. rosso fegato e 1 UIC-X di 2a cl. grigio ardesia, ep. IV**

FS, 3-tlg. Set Reisezugwagen „Alpen-Express“, bestehend aus 1 x CIWL Speisewagen 1925T, 1 x 1.Kl. Wagen UIC-X in rot/grauer Farbgebung und 1 x 2.Kl. Wagen UIC-X in grauer Farbgebung, Ep. IV  
 FS, coffret de 3 voitures « Alpen-Express », composé de 1 voiture-restaurant CIWL WR 1925T, 1 voiture de 1ère classe UIC-X en livrée rouge/grise et 1 voiture de 2ème classe UIC-X en livrée grise, ép. IV  
 FS, set de 3 coches "Alpen-Express", compuesto de 1 coche restaurante CIWL WR 1925T, 1 coche de primera clase UIC-X en decoración roja/gris y 1 coche de segunda clase UIC-X en decoración gris, ép. IV  
 FS, 3-unit pack of coaches "Alpen-Express", including 1 restaurant coach CIWL WR 1925T, 1 x 1st class coach UIC-X in red/grey livery and 1 x 2nd class coach UIC-X in grey livery, ep. IV-V



Assi sostitutivi per corrente alternata: HC6102 (10.50 x 24.50 mm)

**Espresso 280/281 "Alpen Express"**

I primi collegamenti tra Roma Termini ed il nord Europa lungo l'asse del Brennero denominati "Alpen Express" risalgono al 1952, con sezioni dirette per Germania, Danimarca, Belgio o Olanda. Negli anni vi sono stati numerosi cambiamenti di percorso, con composizioni variabili che comprendevano carrozze tedesche, italiane, danesi e in carico alla CIWL. Nel 1981 il treno perse la sezione danese, dal 1984 definitivamente limitato a Monaco ed effettuato con solo materiale FS, per poi essere sostituito nel 1987 dall'Eurocity "Michelangelo" sullo stesso percorso. Su questo treno hanno sempre fatto presenza fissa le carrozze ristorante ex CIWL 1925T "Pistoiesi".

**HR4362**

IV

**FS****NEW****FS, set di 3 carrozze "Alpen-Express", composto da 2 carrozze UIC-X di 2a classe in livrea rosso fegato e 1 bagagliaio UIC-X '70 in livrea grigio ardesia, ep. IV**

FS, 3-tlg. Set Reisezugwagen „Alpen-Express“, bestehend aus 2 x 2.Kl. Wagen UIC-X in rot/grauer Farbgebung und 1 x Gepäckwagen UIC-X '70, Ep. IV  
 FS, coffret de 3 voitures « Alpen-Express », composé de 2 voitures de 2ème classe UIC-X en livrée rouge/grise et 1 fourgon UIC-X '70 en livrée grise, ép. IV  
 FS, set de 3 coches "Alpen-Express", compuesto de 2 coches de segunda clase UIC-X en decoración roja/gris y 1 furgón UIC-X '70 en decoración gris, ép. IV  
 FS, 3-unit pack of coaches "Alpen-Express", including 2 x 2nd coaches UIC-X in red/grey livery and 1 x luggage van UIC-X '70 in grey livery, ep. IV



Assi sostitutivi per corrente alternata: HC6102 (10.50 x 24.50 mm)

**Carrozze UIC-X FS**

- Carrozze di 1ª o 2ª classe dei tipi 1968, 1975 o 1982 e bagagliaio Tipo 1970 senza carenature in livrea rosso fegato o grigio ardesia in base alla versione riprodotta, in numerazioni e varianti inedite
- Nuovi predellini sulle porte di salita
- Nuova riproduzione dei freni a disco sui carrelli
- Targhe di percorrenza specifiche in fotoincisione fornite in bustina





HR4374



FS/DB/NS

**NEW**

**“Italien-Holland Express”, set di 4 carrozze, 1 letti MU NS livrea TEN, 1 cuccetta DB Bcm 243 blu/beige, 1 UIC-X 2° cl. FS rosso fegato e 1 cuccetta UIC-X '68 FS rosso fegato, ep. V**

„Italien-Holland-Express“, 4-tlg. Set Reisezugwagen, bestehend aus 1 x NS WLABm MU, in TEN-Farbgebung, 1 x DB Bcm 243, in blau/beiger Farbgebung, 1 x FS 2.Kl. UIC-X, in rot/grauer Farbgebung und 1 x FS Liegewagen UIC-X '68, in rot/grauer Farbgebung, Ep. V

« Italien-Holland-Express », composé de 1 voiture NS WLABm MU en livrée TEN, 1 voiture DB Bcm 243 en livrée bleue/beige, 1 voiture FS de 2ème classe UIC-X en livrée rouge/grise et 1 voiture-couchette FS en livrée rouge/grise UIC-X '68, ép. V

“Italien-Holland Express”, set de 4 coches, compuesto de un coche WLABm MU de la NS en decoración “TEN”, un Bcm 243 de la DB en azul/beige, un 2º clase UIC-X de la FS en rojo/gris y un literas UIC-X '68 de la FS en rojo/gris, ép. V

“Italien-Holland-Express”, 4-unit pack of coaches, including 1 x NS coach WLABm MU in TEN livery, 1 x DB coach Bcm 243 in blue/beige livery, 1 x FS 2nd class coach UIC-X in red/grey livery and 1 x FS couchette coach UIC-X '68 in red/grey livery, ep. V

Assi sostitutivi per corrente alternata: HC6102 (10.50 x 24.50 mm)



**Espresso 200 “Italien-Holland Express” / 201 “Holland-Italien Express”**

Nell'ambito della grande rete di treni espressi internazionali circolanti in Europa sin dagli anni '50, la relazione denominata “Italien-Holland Express” oppure “Holland-Italien Express” (se in direzione sud-nord oppure nord-sud) che collegava Roma con Amsterdam ha sempre giocato un ruolo di primo piano, dovendo attraversare, oltre ad Italia ed Olanda, anche la Svizzera via Chiasso/Gottardo e la Germania lungo la valle del Reno, con fermate intermedie nelle città più importanti incontrate nel percorso come Milano, Basilea, Bonn, Colonia e Utrecht solo per citarne alcune. Come sempre in questi casi, la composizione era notevolmente variabile lungo il percorso, data la presenza di sezioni non solo per Amsterdam ma anche limitate in Svizzera o Germania (es. per Basilea, Dortmund, Francoforte o Emmerich in base al periodo) o con origine da Svizzera o Germania; in alcuni periodi dell'anno (estate o festività) il treno aveva origine in Italia da località turistiche come Ventimiglia (per la Riviera Ligure) o Rimini (per la Riviera Romagnola), mentre ad inizio anni '90 venne limitato a Milano anziché Roma.

Data la lunga percorrenza, oltre a normali carrozze diurne e bagagliai, questo treno ha sempre avuto in composizione anche carrozze letti e cuccette, generalmente in carico alle FS, DB e NS, ma occasionalmente si sono viste in composizione anche carrozze letti SNCF o SBB, in particolare nel periodo del pool TEN quando potevano capitare nella rotazione dei turni anche su questa tratta.



**Dettagli modello**

**Carrozze cuccette Bcm243 DB / UIC-X 1968 cuccette FS**

Nuovi stampi per cassa, vetri, interni, sottocassa e dettagli separati. Differenze tra versioni DB, FS e tra sottoserie diverse correttamente riprodotte. Riproduzione dettagliata delle nuove apparecchiature sottocassa, del tetto, delle testate, differenziate in base al tipo di carrozza ed alla sottoserie. Interni interamente riprodotti, con cuccette aperte e scalette in fotoincisione. Nuovi predellini sulle porte di salita, differenziati in base alla sottoserie (fissi o ribaltabili). Carrelli MD36, MDf o 24au in base alla serie della carrozza.

**Carrozze UIC-X FS**

Carrozze UIC-X di 2° classe FS dei tipi 1975, 1979 o 1982 in livrea rosso fegato o grigio ardesia in base alla versione riprodotta, in numerazioni e varianti inedite. Nuovi predellini sulle porte di salita. Nuova riproduzione dei freni a disco sui carrelli.

**Carrozze letti MU**

Carrozze tipo MU 1973 con freni a disco, in livrea TEN con tetto blu, in carico alle Ferrovie Olandesi (NS), versione mai prodotta da Rivarossi. Nuova riproduzione dei freni a disco sui carrelli.

**Per tutte le carrozze**

Cinematismo di aggancio corto a norma NEM 362. Respingenti e tubolari degli intercomunicanti molleggiati, Targhe di percorrenza specifiche in fotoincisione fornite in bustina, secondo l'Orario Invernale 1993-1994.





HR4375



FS/DB

**NEW**

**“Italien-Holland Express”, set di 4 carrozze, 1 cuccetta DB Bcm 243 blu/beige, 1 UIC-X 2a cl. FS rosso fegato, 1 UIC-X 2° cl. FS grigio ardesia e 1 cuccetta UIC-X '68 FS rosso fegato, ep. V**

„Italien-Holland-Express“, 4-tlg. Set Reisezugwagen, bestehend aus 1 x DB Bcm 243, in blau/beiger Farbgebung, 1 x FS 2.Kl. UIC-X, in rot/grauer Farbgebung, 1 x FS 2.Kl. UIC-X, in grauer Farbgebung und 1 x FS-Liegewagen UIC-X '68, in rot/grauer Farbgebung, Ep. V

« Italien-Holland-Express », composé de 1 voiture DB Bcm 243 en livrée bleue/beige, 1 voiture FS de 2ème classe UIC-X en livrée rouge/grise, 1 voiture FS de 2ème classe UIC-X en livrée grise et 1 voiture-couchette FS en livrée rouge/grise UIC-X '68, ép. V

“Italien-Holland Express”, set de 4 coches, compuesto de un coche Bcm 243 de la DB en azul/beige, un 2º clase UIC-X de la FS en rojo/gris, un 2º clase UIC-X de la FS en gris y un literas UIC-X '68 de la FS en rojo/gris, ép. V

“Italien-Holland-Express”, 4-unit pack of coaches, including 1 x DB coach Bcm 243 in blue/beige livery, 1 x FS 2nd class coach UIC-X in red/grey livery, 1 x FS 2nd class coach UIC-X in grey livery and 1 x FS couchette coach UIC-X '68 in red/grey livery, ep. V

Assi sostitutivi per corrente alternata: HC6102 (10.50 x 24.50 mm)



Photo: Giorgio Stagni

**HR4376****FS****NEW****FS, set di 2 carrozze cuccette UIC-X Tipo 1968, livrea XMPR, ep. V**

FS, 2-tlg. Set Liegewagen UIC-X '68, in XMPR-Farbgebung, Ep. V

FS, coffret de 2 voitures couchettes UIC-X Type 1968, livrée XMPR, ép. V

FS, set de dos coches literas UIC-X '68, decoración "XMPR", ép. V

FS, 2-unit pack of couchette coaches UIC-X '68, XMPR livery, ep. V



Assi sostitutivi per corrente alternata: HC6102 (10.50 x 24.50 mm)

**Carrozze UIC-X 1968 a cuccette delle FS**

Le cuccette Tipo 1968 rappresentano la prima serie di carrozze di questo tipo costruite sulla piattaforma UIC-X per le FS; derivate direttamente dalle UIC-X 1968 diurne costruite in contemporanea, ne mantengono la stessa struttura della cassa ma diversa organizzazione degli interni, presentando 10 scompartimenti per i viaggiatori più 1 per l'accudiente, con 4 lavabi oltre alle 2 ritirate. La prima sottoserie di 92 carrozze venne consegnata tra il 1968 ed il 1970, caratterizzata dai carrelli 24au, aria soffiata di tipo

Westclimat e riscaldamento a vapore, subito seguita nel 1970-71 da un'altra sottoserie di 160 carrozze identiche alla prima ma senza riscaldamento a vapore, per finire la fornitura nel 1973 con un'ultima sottoserie di 30 unità dotate di carrelli MDfd con freni a disco, che garantivano migliori qualità di marcia, ed impianto ad aria soffiata Friedmann, analogamente alle carrozze diurne della stessa serie. Nel corso degli anni, come tutte le carrozze UIC-X, hanno subito diverse modifiche come l'installazione di

nuove porte in lega, gradini di salita ribaltabili ed altri aggiornamenti tecnici; anche la livrea è cambiata nel tempo, passando dall'originale grigio ardesia al rosso fegato/grigio beige negli anni '80 ed all'XMPR negli anni '90, quest'ultima mantenuta fino a fine carriera avvenuta attorno al 2010 per questa serie di carrozze.

**HR4349****DB****NEW****DB, set di 3 carrozze, treno notturno "Luna", composto da 1 carrozza Club WGMh 854 in livrea rosso/beige e 2 carrozze Bcm 246 in livrea blu oceano/beige, ep. IV**

DB, 3-tlg. Set Nachtschnellzug „Luna“, bestehend aus 1 x Bar-Gesellschaftswagen WGMh 854, in rot/beiger Farbgebung und 2 x Bcm 246, in ozeanblauer Farbgebung, Ep. IV

DB, coffret de 3 voitures, train de nuit « Luna », composé de 1 voiture Club WGMh 854 en livrée rouge/beige et 2 voitures Bcm 246 en livrée bleu océan, ép. IV

DB, set de 3 coches, tren nocturno "Luna", compuesto de 1 coche Club WGMh 854 en decoración rojo/beige y 2 coches bcm 246 en decoración océano azul, ép. IV

DB, 3-unit pack, night train "Luna", including 1 Club coach WGMh 854 in red/beige livery and 2 coaches Bcm 246 in ocean blue livery, ep. IV



Assi sostitutivi per corrente alternata: HC6102 (10.50 x 24.50 mm)







HR4377



DB

**NEW**

**DB, set di 2 carrozze cuccette Bcm<sup>243</sup>, livrea verde, ep. III**

DB, 2-tlg. Set Liegewagen Bcm<sup>243</sup>, in grüner Farbgebung, Ep. III

DB, coffret de 2 voitures couchettes Bcm<sup>243</sup>, livrée verte, ép. III

DB, set de dos coches literas Bcm<sup>243</sup>, decoración verde, ép. III

DB, 2-unit pack of couchette coaches Bcm<sup>243</sup>, green livery, ep. III



Assi sostitutivi per corrente alternata: HC6102 (10.50 x 24.50 mm)



HR4378



Nightjet

**NEW**

**NightJet, set di 2 carrozze cuccette Bvcmz<sup>248.5</sup>, livrea blu, ep. VI**

NightJet, 2-tlg. Set Liegewagen Bvcmz<sup>248.5</sup>, in blauer Farbgebung, Ep. VI

NightJet, coffret de 2 voitures couchettes Bvcmz<sup>248.5</sup>, livrée bleue, ép. III

NightJet, set de dos coches literas Bvcmz<sup>248.5</sup>, decoración azul, ép. VI

NightJet, 2-unit pack of couchette coaches Bvcmz<sup>248.5</sup>, blue livery, ep. VI



Assi sostitutivi per corrente alternata: HC6102 (10.50 x 24.50 mm)



**HR4365****III** **FS****NEW****FS, set di 3 carrozze Tipo 1946, composto da 1 bagagliaio Dz 83000, 1 carrozza di 1a classe Az 13010 e 1 carrozza di 2a classe Bz 33010, livrea castano, ep. III**

FS, 3-tlg. Set Reisezugwagen, in brauner Castano-Farbgebung, bestehend aus 1 x Gepäckwagen Dz 83000, 1 x 1.Kl. Wagen Az 13010 - Typ 1946 und 1 x 2.Kl. Wagen Bz33010 - Typ 1946, Ep. III

FS, coffret de 3 voitures, livrée castano, composé de 1 fourgon Dz 83000, 1 voiture de 1ère classe Az 13010 Type 1946 et 1 voiture de 2ème classe Bz33010 Type 1946, ép. III

FS, set de 3 coches, compuesto de un furgón Dz 83000, un coche de primera clase Az 13010 Tipo 1946 y uno de segunda clase Bz 33010 Tipo 1946, decoración "castaño", ép. III

FS, 3-unit pack of coaches, castano livery, including 1 x luggage van Dz 83000, 1 x 1st class coach Az 13010 Type 1946 and 1 x 2nd class coach Bz33010 Type 1946, ep. III

Assi sostitutivi per corrente alternata: HC6102 (10.50 x 24.50 mm)

*Fotomontage / Fotomontaje / Photomontage / Fotomontaggio***HR4366****IV** **FS****NEW****FS, set di 2 carrozze Tipo 1946, composto da 1 bagagliaio per trasporto biciclette Dz 83000 e 1 carrozza di 2a classe Bz 33010, livrea grigia, ep. IV**

FS, 2-tlg. Set Reisezugwagen, in grauer Farbgebung, bestehend aus 1 x Gepäckwagen Dz 83000 für Fahrradtransport und 1 x 2.Kl. Wagen Bz33010 - Typ 1946, Ep. IV

FS, coffret de 2 voitures, livrée grise, composé de 1 fourgon Dz 83000 pour le transport de vélos et 1 voiture de 2ème classe Bz33010 Type 1946, ép. IV

FS, set de 2 coches, compuesto de un furgón para el transporte de bicicletas Dz 83000 y un coche de segunda clase Bz 33010 Tipo 1946, decoración gris, ép. IV

FS, 2-unit pack of coaches, grey livery, including 1 luggage van for bicycles transport Dz 83000 and 1 2nd class coach Bz 33010 Type 1946, ep. IV

Assi sostitutivi per corrente alternata: HC6102 (10.50 x 24.50 mm)

*Fotomontage / Fotomontaje / Photomontage / Fotomontaggio*



**HR4367****III****523****L****K****FS****NEW****FS, set di 2 carrozze Tipo 1946, composto da 2 carrozze di 2a classe Bz 33010, una con comparto ristoro, livrea castano/Isabella, ep. III**

FS, 2-tlg. Set 2.Klasse Reisezugwagen Bz 33010 - Typ 1946, in brauner Castano/Isabella-Farbgebung, einer davon mit Buffett-Abteil, Ep. III

FS, coffret de 2 voitures, livrée castano/Isabella, composé de 1 voiture de 2ème classe avec compartiment buffet Bz 33010 Type 1946 et 1 voiture de 2ème classe Bz 33010 Type 1946, ép. III

FS, set de 2 coches, compuesto de un coche de segunda clase Bz 33010 Tipo 1946 con cabina "ristoro" y uno de segunda clase Bz 33010, decoración "castaño/Isabella", ép. III

FS, 2-unit pack of coaches, Castano/Isabella livery, including 1 x 2nd class coach Bz 33010 Type 1946 with "ristoro" compartment and 1 x 2nd class coach Bz 33010, ep. III

Assi sostitutivi per corrente alternata: HC6102 (10.50 x 24.50 mm)

*Fotomontage / Fotomontaje / Photomontage / Fotomontaggio***HR4368****III-IV****523****L****K****FS****NEW****FS, set di 2 carrozze Tipo 1946, composto da 2 carrozze di 2a classe Bz 33010, una con comparto ristoro, livrea grigio ardesia, marcatura FS, ep. III-IV**

FS, 2-tlg. Set, bestehend aus einem Wagen 2. Kl. Bz 33010 der Bauart 1946 mit „Ristoro“-Abteil und einem Wagen 2. Kl. Bz 33010 in „grigio ardesia“ mit FS-Anschriften, Ep. III-V

FS, coffret de 2 voitures, composé d'une voiture de 2e cl. Bz 33010 du type 1946 avec compartiment « Ristoro » et d'une voiture de 2e cl. Bz 33010 en « grigio ardesia » avec inscriptions FS, ép. III-IV

FS, set de 2 coches, compuesto de un coche de segunda clase Bz 33010 Tipo 1946 con cabina "ristoro" y uno de segunda clase Bz 33010, decoración "grigio ardesia" con inscripciones FS, ép. III-IV

FS, 2-unit pack Bz 33010 Type 1946 2nd class, one with "ristoro" compartment, FS markings, grey livery, ep. III-IV

Assi sostitutivi per corrente alternata: HC6102 (10.50 x 24.50 mm)

*Fotomontage / Fotomontaje / Photomontage / Fotomontaggio*

171



HR4399

IV FS

**NEW**

**FS, carrozza letti MU '73 in livrea TEN, tetto color alluminio, logo FS a "televisore" + logo "Raitour", ep. IV**

FS, Schlafwagen der Bauart MU '73 in TEN-Lackierung, Aluminiumdach, abgerundetes FS-Logo + „Raitour“-Logo, Ep. IV

FS, voiture-lits MU '73 en livrée TEN, toit en couleur aluminium, logo FS arrondi + logo « Raitour », ép. IV

FS, coche cama MU '73 en livrea TEN, techo en color aluminio, logotipo FS redondeado + logotipo "Raitour", ep. IV

FS, sleeping coach MU '73 in TEN livery, aluminium roof, rounded FS logo + "Raitour" logo, ep. IV

Assi sostitutivi per corrente alternata: HC6102 (10.50 x 24.50 mm)

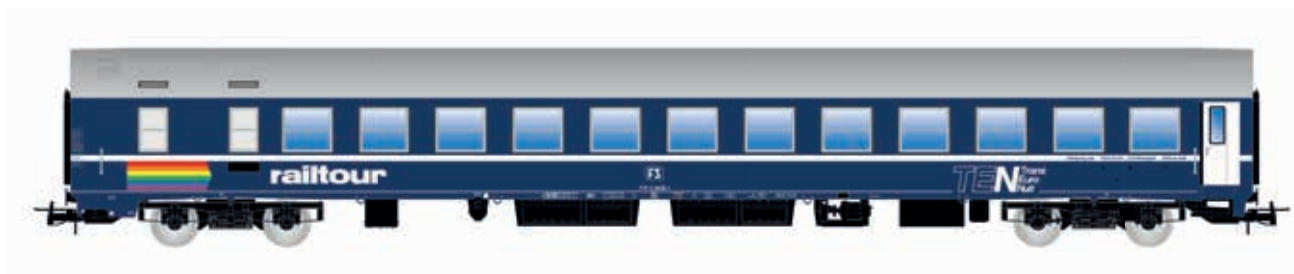

HR4400

IV FS

**NEW**

**FS, carrozza letti tipo MU '73 in livrea CIWL con emblema, ep. IV**

FS, Schlafwagen der Bauart MU '73 in CIWL-Farbgebung mit Emblem, Ep. IV

FS, voiture-lits type MU '73 en livrée CIWL avec emblème, ép. IV

FS, coche cama tipo MU '73, decoración CIWL con escudo, ép. IV

FS, sleeping coach type MU '73 in CIWL livery with emblem, ep. IV

Assi sostitutivi per corrente alternata: HC6102 (10.50 x 24.50 mm)







HR4389



DB

**NEW**

**DB, set di 5 carrozze passeggeri "Blauer Enzian", livrea blu, ep. III**

DB, 5-tlg. Zugset „Blauer Enzian“ in blauer Farbgebung, Ep. III

DB, coffret de 5 voitures voyageurs « Blauer Enzian », livrée bleue, ép. III

DB, set de 5 coches del tren "Blauer Enzian", decoración azul, ép. III

DB, 5-unit pack luxury passenger train "Blauer Enzian", blue livery, ep. III



Photo: Collezione Rivarossi

**Blauer Enzian-Zug**

Ab Sommerfahrplan 1953 wurde der Zug durch die eingesetzten Wagen aus den Fernschnellzügen herausgehoben. Die Garnitur des früheren Henschel-Wegmann-Zuges, die einen Aussichts-Schlusswagen nach US-Vorbild führte (Kanzelwagen), wurde speziell für diesen Einsatz aufgearbeitet. Wegen Problemen beim Umbau der Zuggarnitur, die ursprünglich aus Wagen mit Abteilen zweiter und dritter Klasse bestand, entschied die DB, den Zug generell auf die (damalige) zweite Wagenklasse umzurüsten.

Der Name „Blauer Enzian“, den die Verbindung seit Sommerfahrplan 1952 trug, war das Ergebnis eines Preisausschreibens, das die DB unter ihren Fahrgästen 1951 veranstaltete. Insgesamt wurden so für neun F-Zug-Paare Namen vergeben. Für den F 55/56 kristallisierte sich der Name „Blauer Enzian“ als Gewinner heraus. Enzian ist wie das Edelweiß – namensgebend für den Edelweiss-Express – eine Alpenblume und Heilpflanze. In Europa wachsen etwa 35 Enzian-Arten vorwiegend in den Alpen. Möglicherweise wegen ihrer im Pflanzenreich seltenen reinblauen und leuchtenden Blütenfarbe, wurden und werden sie als Symbol für die Treue betrachtet und werden so in Gedichten und Liedern erwähnt. Streckenführung und Farbgebung des Zugs können die Assoziation erklären.



HR4346

IV

1224

L

K

DB

**DB, 4-tlg. Set Reisezugwagen „TEE Rheingold“, in beige/roter Lackierung, bestehend aus 2 x 1. Kl. Wagen Avmz, 1 x 1 Kl. Wagen Apmz und 1 x Speisewagen WRmh<sup>132</sup>, Ep. IV**

DB, set di 4 carrozze "TEE Rheingold", livrea beige/rossa, composto da 2 carrozze di 1a classe Avmz, 1 carrozza di 1a classe Apmz e 1 carrozza ristorante WRmh<sup>132</sup>, ep. IV

DB, coffret de 4 voitures « TEE Rheingold », livrée beige/rouge, composé de 2 voitures de 1ère classe Avmz, 1 voiture de 1ère classe Apmz et 1 voiture restaurant WRmh<sup>132</sup>, ép. IV

DB, set de 4 coches «TEE Rheingold», decoración beige/roja, compuesto de 2 coches de primera clase Avmz, 1 coche de primera clase Apmz y 1 coche restaurante WRmh<sup>132</sup>, ép. IV

DB, 4-unit set of coaches "TEE Rheingold", beige/red livery, including 2 1st class coaches Avmz, 1 1st class coach Apmz and 1 restaurant coach WRmh<sup>132</sup>, period IV



Assi sostitutivi per corrente alternata: HC6102 (10.50 x 24.50 mm)





**HR4347****IV****1212****L****K****DB****DB, 4-tlg. Set Reisezugwagen „TEE Rheingold“, in beige/roter Lackierung, bestehend aus 2 x 1. Kl. Wagen Avmz<sup>111</sup>, 1 x 1. Kl. Wagen Apmz<sup>121</sup> und 1 x Clubwagen WGmh<sup>804</sup>, Ep. IV**DB, set di 4 carrozze «TEE Rheingold», livrea beige/rossa, composto da 2 carrozze di 1a classe Avmz<sup>111</sup>, 1 carrozza di 1a classe Apmz<sup>121</sup> e 1 carrozza Club WGmh<sup>804</sup>, ep. IVDB, coffret de 4 voitures «TEE Rheingold», livrée beige/rouge, composé de 2 voitures de 1ère classe Avmz<sup>111</sup>, 1 de 1ère classe Apmz<sup>121</sup> et 1 voiture Club WGmh<sup>804</sup>, ép. IVDB, set de 4 coches «TEE Rheingold», decoración beige/roja, compuesto de 2 coches de primera clase Avmz<sup>111</sup>, 1 coche de primera clase Apmz<sup>121</sup> y 1 coche Club WGmh<sup>804</sup>, ép. IVDB, 4-unit set of coaches «TEE Rheingold», beige/red livery, including 2 1st class coaches Avmz<sup>111</sup>, 1 1st class coach Apmz<sup>121</sup> and 1 Club coach WGmh<sup>804</sup>, period IV

Assi sostitutivi per corrente alternata: HC6102 (10.50 x 24.50 mm)

**Reisezugwagen „TEE Rheingold“**

Mit Einführung des zweiklassigen „IC 79“-Systems, wurden nach und nach immer mehr TEE-Züge in dieses integriert. Eine der wenigen Ausnahmen war der TEE „Rheingold“. Die Deutsche Bundesbahn entschloss sich Anfang der achtziger Jahre diesen Zug wieder zu einem Luxuszug aufzuwerten.

Dazu wurden mehrere InterCity-Wagen sowie Speisewagen umgebaut und modernisiert. Zu erkennen waren diese Wagen an ihrer rot-beigen Lackierung, die nun unterhalb der Fenster einen orangen Zierstreifen besaß. Ebenso war der Schriftzug „Restaurant“ an den Speisewagen in Orange ausgeführt.

Der Zug verkehrte auf wechselnden Laufwegen von Amsterdam nach Basel mit einem Flügelzug nach München bzw. Salzburg. Der 30. Mai 1987 war der letzte Verkehrstag des TEE „Rheingold“. Mit ihm endete die Ära der Trans-Europ-Express-Züge in Deutschland.



**HR4397****IV****606****L****K****DB****NEW****DB, set di 2 carrozze di 1a classe del tipo Avmz<sup>111</sup> in colorazione Rheingold-'83, ep. IV (per completare i set HR4346 e HR4347)**DB, 2-tlg. Set 1.-Kl.-Wagen der Bauart Avmz<sup>111</sup> in Rheingold-'83-Farbgebung, Ep. IV (zur Komplettierung der Sets HR4346 und HR4347)DB, coffret de 2 voitures de 1ère classe du type Avmz<sup>111</sup> en livrée Rheingold '83, ép. IV (pour compléter les coffrets HR4346 et HR4347)DB, set de dos coches tipo Avmz<sup>111</sup>, decoración "Rheingold 1983", ép. IV (para completar los sets HR4346 y HR4347)DB, 2-unit pack Avmz<sup>111</sup> 1st cl. coaches in Rheingold 1983 livery, ep. IV (they complete the packs HR4346 and HR4347)

Assi sostitutivi per corrente alternata: HC6102 (10.50 x 24.50 mm)

*Fotomontage / Fotomontaje / Photomontage / Fotomontaggio***HR4348****IV****303****L****K****DB****DB, carrozza Club WGmh<sup>854</sup>, livrea "InterRegio", ep. IV**DB, Bar-Gesellschaftswagen WGmh<sup>854</sup>, in „InterRegio“-Farbgebung, Ep. IVDB, voiture Club WGmh<sup>854</sup>, livrée « InterRegio », ép. IVDB, coche Club WGmh<sup>854</sup>, decoración «InterRegio», ép. IVDB, Club coach WGmh<sup>854</sup>, "InterRegio" Livery, ep. IV

Assi sostitutivi per corrente alternata: HC6102 (10.50 x 24.50 mm)





**HR4395****VI****303****E****K****DB****NEW****DB, carrozza bar WGmh<sup>804</sup> per treni storici in livrea originale, ep. VI**DB, Barwagen WGmh<sup>804</sup> in Ursprungsfarbgebung für historische Züge, Ep. VIDB, voiture-bar WGmh<sup>804</sup> pour trains historiques en livrée d'origine, ép. VIDB, coche bar tipo WGmh<sup>804</sup>, para trenes históricos, ép. VIDB, bar coach WGmh<sup>804</sup> for historic trains in original livery, ep. VI

Assi sostitutivi per corrente alternata: HC6102 (10.50 x 24.50 mm)

*Fotomontage / Fotomontaje / Photomontage / Fotomontaggio***HR4350****VI****619****E****K****EURO-EXPRESS****Euro-Express, set di 2 carrozze, composto da 1 carrozza "Partywagen" WGmh 804/854 e 1 carrozza ristorante WRmh 132, ep. VI**

Euro-Express, 2-tlg. Set Reisezugwagen, bestehend aus 1 x Partywagen WGmh 804/854 und 1 x Speisewagen WRmh 132, Ep. VI

Euro-Express, coffret de 2 voitures, composé de 1 voiture « Partywagen » WGmh 804/854 et 1 voiture restaurant WRmh 132, ép. VI

Euro-Express, set de 2 coches, compuesto de 1 coche "Partywagen" WGmh 804/854 y 1 coche restaurante WRmh 132, ép. VI

Euro-Express, 2-unit set of coaches, including 1 "Partywagen" coach WGmh 804/854 and 1 restaurant coach WRmh 132, ep. VI



Assi sostitutivi per corrente alternata: HC6102 (10.50 x 24.50 mm)



**HR4373****VI****922****L****K****DB****DB, set di 3 carrozze "TEE Bavaria", livrea rossa/beige, composto da 1 carrozza Apmz, 1 carrozza Avmz e 1 carrozza ARDm, ep. IV**

DB, 3-tlg. Set Reisezugwagen „TEE Bavaria“ in rot/beiger Farbgebung, bestehend aus 1 x Apmz, 1 x Avmz, 1 x ARDm, Ep. IV

DB, coffret de 3 voitures « TEE Bavaria », livrée rouge/beige, composé de 1 voiture Apmz, 1 voiture Avmz et 1 voiture ARDm, ép. IV

DB, set de 3 coches «TEE Bavaria», decoración roja/beige, compuesto de 1 coche Apmz, 1 coche Avmz y 1 coche ARDm, ép. IV

DB,3-unit set of coaches "TEE Bavaria", red/beige livery, including 1 coach Apmz, 1 coach Avmz and 1 coach ARDm, ep. IV

Assi sostitutivi per corrente alternata: HC6102 (10.50 x 24.50 mm)

**TEE Bavaria**

Ein sehr bekannter, internationaler Fernzug, war der „Bavaria“. Von 1969 bis 1977 war er Bestandteil des Trans-Europäischen-Eisenbahn-Netzes, kurz TEE genannt. Er verkehrte in der Relation München – Zürich und befuhr dabei die landschaftlich schöne Allgäubahn bis Lindau. Die zunächst eingesetzten 4-teiligen Dieseltriebzüge des Typs RAm wurden nach einem schweren Unfall 1971 dort nicht mehr eingesetzt.

Als Nachfolge wurden die deutschen TEE-Wagen des Typs Avmz 111 (Abteilwagen) und Apmz 121 (Großraumwagen) sowie als Besonderheit der extra in TEE-Farben lackierte SBB-Speisewagen WRm eingesetzt. Mit den goldbedampften Einstiegstüren, den Aufschriften „TEE“ mit Ring-Umrandung sowie „Restaurant“ war dieser schon von weitem von allen anderen TEE-Wagen leicht zu unterscheiden. Der Zug verkehrte drei- bzw. vierteilig, je nach Auslastung.

Als Zuglokomotiven kam die neue Baureihe 210 zwischen München und Lindau zum Einsatz, ersatzweise auch die Baureihe 218, zunächst im ursprünglichen purpurrot, ab Mitte der 1970-er Jahre auch in den neuen Farben ozeanblau/beige.

Ab 1977 wurde der TEE 66/67 „Bavaria“ zum D-Zug herabgestuft und Ende 2002 verlor die Zugverbindung München – Zürich endgültig den Namen „Bavaria“.





**HR4392**

845

**DR****NEW****DR, set di 4 carrozze a due piani con carrozza pilota, livrea verde con con tetto grigio, ep. III**

DR, 4-tlg. Doppelstockeinheit mit Steuerabteil, in grüner Farbgebung mit grauem Dach, Ep. III

DR, coffret de 4 voitures à deux niveaux avec voiture-pilote, livrée verte toit gris, ép. III

DR, set de 4 coches de doble piso con coche piloto, con techo verde/gris, ép. III

DR, 4-unit double-decker coach with cab-control unit, with green/grey roof, ep. III

*Fotomontage / Fotomontaje / Photomontage / Fotomontaggio***DR Doppelstockwagen**

In der DDR entwickelte 1952 der VEB Waggonbau Görlitz (ehemals Waggon- und Maschinenbau AG (WUMAG)) für die Deutsche Reichsbahn auf den LBE-Fahrzeugen aufbauende zwei- und vierteilige Doppelstockzüge. Von den 39,9 Meter langen und 76 Tonnen schweren Zweiteilern DB7, später DBz, lieferte Görlitz 1955 nur zwölf Einheiten aus. Sie verfügten über 228 Sitz- und 210 Stehplätze. Die vierteiligen 73,4 Meter langen DB13, später DBv, waren mit 152 Exemplaren im Betriebsmittelpark der DR vertreten. Sie boten insgesamt 906 Fahrgästen Platz. Zwei- und vierteilige Einheiten waren fast identisch, bei den zweiteiligen fehlten nur die Mittelwagen.

Wie bei den LBE-Wagen lagen je zwei einzelne Wagen auf einem Jakobsdrehgestell auf, die Türen befanden sich über den Drehgestellen. Aus Achslastgründen insbesondere beim Einsatz auf Nebenbahnen waren die Jakobsdrehgestelle im Gegensatz zu denen der LBE-Wagen dreiachsig. Der Wagenkasten war in selbsttragender Ganzstahl-Leichtbauweise ausgeführt.

Lauftechnisch waren die Fahrzeuge für 120 km/h ausgelegt, bremstechnisch betrug die zulässige Geschwindigkeit anfangs 100 km/h. Die Einheiten wurden mit Hildebrand-Knorr-Personenzugbremse geliefert, wegen des hohen Anteils der Reisenden an der Gesamtmasse von Anfang an mit automatischer Lastabbremmung (Hik-GP-A).

Die Wagen hatten beidseitig zwei Doppeltüren mit einer lichten Breite von 1,5 Metern im einstöckigen Bereich über den Drehgestellen. In den Endwagen befanden sich im einstöckigen Bereich auch eine Toilette und ein Dienstabteil. Innentüren zwischen Einstiegs- und Fahrgasträumen wurden bei den zwei- und vierteiligen Einheiten nicht vorgesehen. Die Fenster im Oberstock waren geteilt, der untere, senkrechte Teil konnte mit einer Kurbel geöffnet werden. Bei den übrigen Fenstern war das obere Drittel nach innen klappbar. Die Sitzplatzanordnung betrug 2+3 bei halbhohen Rückenlehnen, bei der Abschaffung der dritten Wagenklasse wurden die Fahrzeuge in die zweite Klasse umgestuft.

Hornby archive



179



HR4393

IV

845

L

K

DR

DR

**NEW**

**DR, set di 4 carrozze a due piani senza carrozza pilota, livrea verde con con tetto grigio, ep. IV**

DR, 4-tlg. Doppelstockeinheit ohne Steuerabteil, in grüner Farbgebung mit grauem Dach, Ep. IV

DR, coffret de 4 voitures à deux niveaux sans voiture-pilote, livrée verte toit gris, ép. IV

DR, set de 4 coches de doble piso sin coche piloto, con techo verde/gris, ép. IV

DR, 4-unit double-decker coach without cab-control unit, with green/grey roof, ep. IV



Fotomontage / Fotomontaje / Photomontage / Fotomontaggio





HR4394



DR

**NEW**

**DR, serie di 4 carrozze a due piani con scomparto di comando e pannelli frontali di destra in livrea verde/grigia, grande logo "DR", scritte IV**

DR, 4-tlg. Doppelstockeinheit mit Steuerabteil und gerade Frontseiten in grün/grauer Farbgebung, großes „DR“-Logo, Ep. IV

DR, coffret de 4 voitures à deux niveaux avec compartiment de commande et faces avant droites en livrée verte/grise, grand logo « DR », ép. IV

DR, set de 4 coches de dos pisos con coche piloto y testeros rectos en livrea verde/gris, gran logotipo "DR", ep. IV

DR, 4-unit double-decker coach with driver's cab, straight fronts, green and grey livery "DR", ep. IV



Fotomontage / Fotomontaje / Photomontage / Fotomontaggio

**HR4380****IV****606****K****DR****DR, set di 2 carri DDm<sup>916</sup> per trasporto auto al seguito, livrea verde, ep. IV**DR, 2-tlg. Set Autotransportwagen DDm<sup>916</sup>, in grüner Farbgebung, Ep. IVDR, coffret de 2 unités, fourgon porte-autos DDm<sup>916</sup>, livrée verte, ép. IVDR, set de 2 unidades, vagón plataforma DDm<sup>916</sup> para coches, decoración verde, ép. IVDR, 2-unit pack of car transporters DDm<sup>916</sup>, green livery, ep. IV*Fotomontage / Fotomontaje / Photomontage / Fotomontaggio***HR4381****V****303****K****DB AG****DB AG, carro DDm<sup>916</sup> per trasporto auto al seguito, livrea verde, ep. V**DB AG, Autotransportwagen DDm<sup>916</sup>, in grüner Farbgebung, Ep. VDB AG, fourgon porte-autos DDm<sup>916</sup>, livrée verte, ép. VDB AG, vagón plataforma portacoaches DDm<sup>916</sup> para coches, decoración verde, ép. VDB AG, car transporter DDm<sup>916</sup>, green livery, ep. V**Die neuen Autotransportwagen der Bauart DDm916**

- Vollständige Neukonstruktion
- Modell mit Chassis aus Zinkdruckguss für einigen tiefliegenden Schwerpunkt
- Unterschiedliche Detaillierung je nach Ausführung
- Viele separate angesetzte Details, teilweise aus rostfreiem Edelstahl geätzt
- Kurzkupplungskulissen nach NEM 352
- Kupplungsaufnahmen nach NEM 362
- Fein profilierte und dunkel vernickelte Radsätze

*Fotomontage / Fotomontaje / Photomontage / Fotomontaggio*



**HR4382****V****303****K****DB Autozug****DB AG, carro DDm<sup>916</sup> per trasporto auto al seguito, livrea rossa, "DB Autozug", ep. V**DB AG, Autotransportwagen DDm<sup>916</sup>, in roter Farbgebung, „DB Autozug“, Ep. VDB AG, fourgon porte-autos DDm<sup>916</sup>, livrée rouge, « DB Autozug », ép. VDB AG, vagón plataforma portacoaches DDm<sup>916</sup> para coches, decoración roja, "DB Autozug", ép. VDB AG, car transporter DDm<sup>916</sup>, red livery, "DB Autozug", ep. V*Fotomontage / Fotomontaje / Photomontage / Fotomontaggio***HR4383****III****303****K****ZXBENET****ZXBENET, carro DDm<sup>916</sup> per trasporto auto al seguito, con griglie protettive, livrea blu, ep. VI**ZXBENET, Autotransportwagen DDm<sup>916</sup>, mit Schutzgittern in blauer Farbgebung, Ep. VIZXBENET, fourgon porte-autos DDm<sup>916</sup> avec des grilles de protection, livrée bleue, ép. VIZXBENET, vagón plataforma portacoaches DDm<sup>916</sup> para coches, con rejillas de protección, decoración azul, ép. VIZXBENET, car transporter DDm<sup>916</sup> with protective lateral grills, blue livery, ep. VI*Fotomontage / Fotomontaje / Photomontage / Fotomontaggio*

**HR6645****IV**242  
C-3**K****FS****NEW****FS, set di 2 carri Gs, cassa a doghe in legno, uno con luci di coda, ep. IV**

FS, 2-tg. Set gedeckter Güterwagen der Bauart Gs (holzbeplante Wände), einer mit roten Schlusslichtern, Ep. IV

FS, coffret de 2 wagons Gs, parois frises de bois, un avec feux fin de convoi, ép. IV

FS, set de dos vagones cerrados tipo Gs, de paredes de tablones, uno con luz de cola, ép. IV

FS, 2-unit pack Gs wagons (walls made from wooden planks), one with red rear lights, ep. IV

Assi sostitutivi per corrente alternata: HC6101 (11.27 x 24.25 mm)



Con luci di coda  
Mit roten Schlusslichtern  
Avec feux fin de convoi  
Con luz de cola  
With red rear lights

**Luci di coda**

- Esatta riproduzione delle lanterne di coda di tipo FS.
- Le luci rosse sono funzionanti, con un realistico lampeggio asincrono tra le due lanterne.
- L'alimentazione è garantita da una pila a bottone all'interno del carro (non fornita).
- Il funzionamento delle luci di coda è controllato da un magnete (incluso nella confezione). Sulla testata del carro equipaggiato con luci di coda vi è un contatto reed nascosto subito sotto il tetto del carro. Avvicinando il magnete vicino alla fine del tetto di questo carro, il contatto reed viene attivato e le luci di coda vengono accese o spente.

**HR6599****IV**534  
C-3**K****DB****DB, set di 2 carri a pareti scorrevoli, livrea argento, "Cargowaggon", ep. IV**

DB, 2-tg. Set Schiebewandwagen in silberner Farbgebung, „Cargowaggon“, Ep. IV

DB, coffret de 2 wagons à parois coulissantes, livrée argent, « Cargowaggon », ép. IV

DB, set de 2 vagones de paredes correzidas, decoración plata, «Cargowaggon», ép. IV

DR, 2-unit set of sliding walls wagons, silver livery, "Cargowaggon", ep. IV

Assi sostitutivi per corrente alternata: HC6102 (10.50 x 24.50 mm)





**HR6597****V**534  
←→**K****FS****FS, set di 2 carri a pareti scorrevoli Habillss, livrea argento/marrone, ep. V**

FS, 2-tlg. Set Schiebewandwagen Habillss in silber/brauner Farbgebung, Ep. V

FS, coffret de 2 wagons à parois coulissantes Habillss, livrée argent/marron, ép. V

FS, set de 2 wagones de paredes correzidas Habillss, decoración plata/marrón, ép. V

FS, 2-unit set of sliding walls wagon Habillss, silver/brown livery, ep. V

Assi sostitutivi per corrente alternata: HC6102 (10.50 x 24.50 mm)

*Fotomontage / Fotomontaje / Photomontage / Fotomontaggio***HR6598****V-VI**534  
←→**K****FS****FS, set di 2 carri a pareti scorrevoli Habillss, livrea XMPR, ep. V-VI**

FS, 2-tlg. Set Schiebewandwagen Habillss in XMPR-Farbgebung, Ep. V-VI

FS, coffret de 2 wagons à parois coulissantes Habillss, livrée XMPR, ép. V-VI

FS, set de 2 wagones de paredes correzidas Habillss, decoración XMPR, ép. V-VI

FS, 2-unit set of sliding walls wagon Habillss, XMPR livery, ep. V-VI

Assi sostitutivi per corrente alternata: HC6102 (10.50 x 24.50 mm)

*Fotomontage / Fotomontaje / Photomontage / Fotomontaggio*

**HR6552****VI****229**  
←→**K****FS****NEW****FS, carro pianale a stanti a 4 assi Res, livrea verde, ep. VI**

FS, vierachsiger Rungenwagen der Bauart Res, in grüner Farbgebung, Ep. VI

FS, wagon plateforme à 4 essieux Res, livrée verte, ép. VI

FS, vagón plataforma de teleros tipo Res, decoración verde, ép. VI

FS, 4-axle stake wagon Res, green livery, ep. VI

Assi sostitutivi per corrente alternata: HC6100 (10.27 x 25.20 mm)

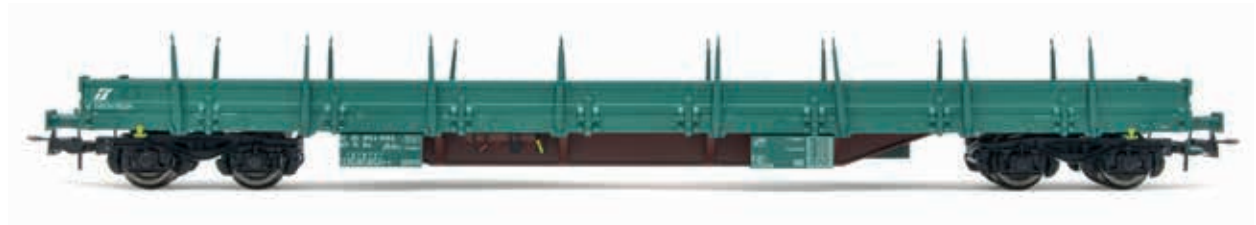
*Fotomontage / Fotomontaje / Photomontage / Fotomontaggio***HR6553****VI****229**  
←→**K****FS****NEW****FS, carro pianale a stanti a 4 assi Res, livrea verde, caricato con bobine di filo, ep. VI**

FS, vierachsiger Rungenwagen der Bauart Res, in grüner Farbgebung, beladen mit Drahtrollen, Ep. VI

FS, wagon plateforme à 4 essieux Res, livrée verte, chargement bobines de fil, ép. VI

FS, vagón plataforma de teleros tipo Res, decoración verde, cargado con bobinas de alambre, ép. VI

FS, 4-axle stake wagon Res, green livery, loaded with wire coils, ep. VI

Assi sostitutivi per corrente alternata: HC6100 (10.27 x 25.20 mm)

*Fotomontage / Fotomontaje / Photomontage / Fotomontaggio*



**HR6612****IV-V****388****K****FS****NEW****FS, set di 2 carri pianale a 4 assi composto da 1 carro Rgs caricato con 2 container da 20 piedi e 1 carro Rgmms caricato con 2 veicoli militari M113, ep. IV-V**

FS, 2-tlg. Set Flachwagen, bestehend aus 1 x Rgs beladen mit 2 x 20' Container und 1 x Rgmms beladen mit zwei Militärfahrzeugen vom Typ M113, Ep. IV-V

FS, coffret de 2 wagons plateforme à 4 essieux, composé d' 1 wagon Rgs chargé avec 2 conteneurs de 20' et 1 wagon Rgmms chargé avec 2 véhicules militaires M113, ép. IV-V

FS, set de 2 wagons plateforme de 4 ejes, compuesto de un vagón Rgs cargado con 2 contenedores de 20' y un Rgmms cargado con 2 vehículos militares, ép. IV-V

FS, 2-unit pack of flat wagons, including 1 x Rgs wagon loaded with 2 x 20' containers and 1 x Rgmms wagon loaded with two military vehicles M113, ep. IV-V

Assi sostitutivi per corrente alternata: HC6100 (10.27 x 25.20 mm)

**HR6647****V-VI****350****K****DB Bahnbau****NEW****DB Bahnbau, set di 2 carri manutenzione, composto da 1 x Res carico di traversine e 1 x Gs, livrea gialla, ep. V-VI**

DB Bahnbau, 2-tlg. Set Bauwagen, beinhaltet 1 x Res beladen mit Schwellen sowie 1 x Gs, beide in gelber Farbgebung, Ep. V-VI

DB Bahnbau, coffret de 2 wagons de maintenance, composé de 1 x Res chargé de traverses et 1 x Gs, livrée jaune, ép. V-VI

DB Bahnbau, set de dos wagons de mantenimiento, compuesto por un vagón Res cargado con traviesas y un Gs, decoración amarillo, yellow livery, ép. V-VI

DB Bahnbau, 2-unit pack maintenance wagons, contains 1 x Res loaded with sleepers and 1 x Gs, both in yellow livery, ep. V-VI

Assi sostitutivi per corrente alternata: (9.60 x 26.00 mm)



**HR6555****FS****NEW****FS, carro pianale a 4 assi Rgs, caricato con 2 coil container “Gruppo Bernardini” da 20 piedi, ep. V**

FS, 4-achs. Flachwagen Rgs, beladen mit 2 x 20' Coil-Container „Gruppo Bernardini“, Ep. V

FS, wagon plateforme à 4 essieux Rgs, chargé avec 2 conteneurs porte-bobines de 20' « Gruppo Bernardini », ép. V

FS, vagón plataforma de teleros tipo Rgs, cargado con 2 Coil-container de 20' “Gruppo Bernardini”, ép. V

FS, flat wagon Rgs, loaded with 2 x 20' coil containers “Gruppo Bernardini”, ep. V

Assi sostitutivi per corrente alternata: HC6100 (10.27 x 25.20 mm)

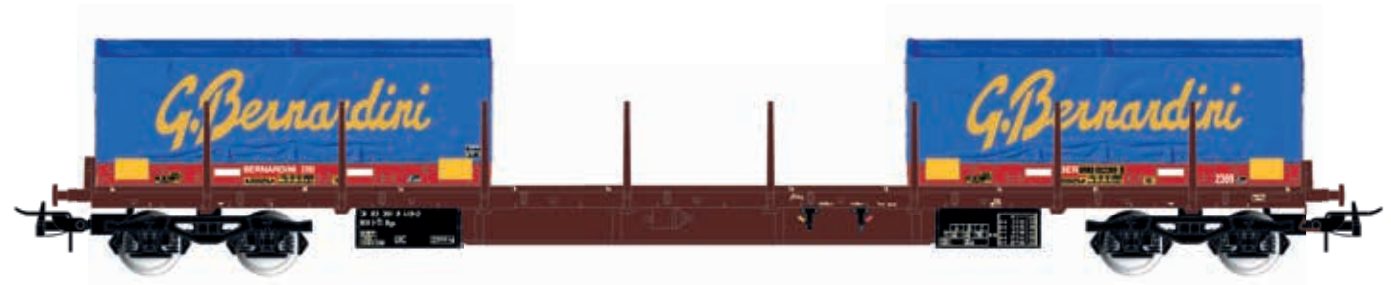
**HR6558****DB Schenker****NEW****DB, carro porta container a 4 assi Rglns, livrea rossa, caricato con 2 Coil-container da 20' “Rheinkraft”, ep. VI**

DB, 4-achs. Containerwagen Rglns, in roter Farbgebung, beladen mit 2 x 20' Coil-Container „Rheinkraft“, Ep. VI

DB, wagon porte-conteneurs à 4 essieux Rglns, livrée rouge, chargé avec 2 conteneurs porte-bobines de 20' « Rheinkraft », ép. VI

DB, vagón portacontenedores tipo Rglns, cargado con 2 Coil-container de 20' “Rheinkraft”, decoración rojo, ép. VI

DB, 4-axle container wagon Rglns, red livery, loaded with 2 x 20' coil containers “Rheinkraft”, ep. VI

Assi sostitutivi per corrente alternata: HC6100 (10.27 x 25.20 mm)



HR6589

VI 465 K

PKP Cargo

**NEW**

**PKP Cargo, set di 3 carri tramoggia a scarico automatico a 4 assi Fals, livrea blu/gialla, ep. VI**

PKP Cargo, 3-tlg. Set 4-achs.Selbstentladwagen Fals, in blau/gelber Farbgebung, Ep. VI

PKP Cargo, coffret de 3 wagons à déchargement automatique à 4 essieux Fals, livrée bleue/jaune, ép. VI

PKP Cargo, set de 3 wagones con autodescarga de 4 ejes Fals, decoración azul/amarillo, ép. VI

PKP Cargo, 3-unit pack of 4-axle self-discharging wagons Fals, blue/yellow livery, ep. VI



HR6590

VI 465 K

AWT

**NEW**

**AWT, set di 3 carri tramoggia a scarico automatico a 4 assi Fals, livrea grigia, ep. VI**

AWT, 3-tlg. Set 4-achs.Selbstentladwagen Fals, in grauer Farbgebung, Ep. VI

AWT, coffret de 3 wagons à déchargement automatique à 4 essieux Fals, livrée gris, ép. VI

AWT, set de 3 wagones con autodescarga de 4 ejes Fals, decoración gris, ép. VI

AWT, 3-unit pack of 4-axle self-discharging wagons Fals, grey livery, ep. VI







HR6625

VI

177

K

DB

**NEW**

**DB, carro tramoggia a 4 assi per il trasporto di cereali con pareti tonde, "Aurora", ep. V**

DB, 4-achs. Schwenkdachwagen mit gewölbten Silowänden für den Getreidetransport, „Aurora“, Ep. V

DB, wagon-trémie à 4 essieux avec parois rondes pour le transport de céréales, « Aurora », ép. V

DB, vagón tolva de 4 ejes con paredes redondas para cereales, «Aurora», ép. V

DB, 4-axle hopper wagon with rounded walls for cereal transport, "Aurora", ep. V



HR6624

VI

342

K

CZ-Interfracht

**NEW**

**CZ-Interfracht, set di 2 carri tramoggia a 4 assi con pareti tonde, ep. VI**

CZ-Interfracht, 2-tlg. Set 4-achs. Schwenkdachwagen mit gewölbten Silowänden, Ep. VI

CZ-Interfracht, coffret de 2 wagons trémies à 4 essieux avec parois rondes, ép. VI

CZ-Interfracht, set de 2 wagones tolva de 4 ejes con paredes redondas, ép. VI

CZ-Interfracht, 2-unit set of 4-axle hopper wagons with rounded walls, ep. VI



**HR6546****VI****362****K****NACCO****NEW****NACCO, set di 2 carri tramoggia a 4 assi Taos, livrea gialla, "Josera", ep. VI**

NACCO, 2-tlg. Set 4-achs. Schwenkdachwagen Taos, in gelber Farbgebung, „Josera“, Ep. VI

NACCO, coffret de 2 wagons trémie à 4 essieux Taos, livrée jaune, « Josera », ép. VI

NACCO, set de dos vagones tolva tipo Taos, decoración amarilla "Josera", ép. VI

NACCO, 2-unit pack of 4-axle hopper wagons Taos, yellow livery, "Josera", ep. VI

**Die neuen Schwenkdachwagen der Bauart Taos**

Die Schwenkdachwagen des Typs Taos wurden ab den 1970er Jahren beschafft. Bis heute werden sie hauptsächlich für den Transport von Quarzsand, Kalk und Tierfutter verwendet und kommen häufig in Ganzzügen zum Einsatz. Aufgrund der über die vergangenen Jahrzehnte wechselnden Besitzer und Mieter dieser Waggonen werden uns die neuen Rivarossi-Modelle in den nächsten Jahren interessante Varianten an Formen und Beschriftungen bieten.



Assi sostitutivi per corrente alternata: HC6100 (10.27 x 25.20 mm)

**HR6547****VI****362****K****D-VTGCH****NEW****D-VTGCH, set di 2 carri tramoggia a 4 assi Taos, livrea grigia, ep. VI**

D-VTGCH, 2-tlg. Set 4-achs. Schwenkdachwagen Taos, in grauer Farbgebung, Ep. VI

D-VTGCH, coffret de 2 wagons trémie à 4 essieux Taos, livrée gris, ép. VI

D-VTGCH, set de dos vagones tolva tipo Taos, decoración gris, ép. VI

D-VTGCH, 2-unit pack of 4-axle hopper wagons Taos, grey livery, ep. VI



Assi sostitutivi per corrente alternata: HC6100 (10.27 x 25.20 mm)





HR6620

IV

242

K

FS

**NEW**

**FS, set di 2 carri cisterna a 2 assi Zgkk, "Agipgas", ep. IV**

FS, 2-tlg. Set 2-achs. Gaskesselwagen, „Agipgas“, Ep. IV

FS, coffret de 2 wagons-citernes à gaz à 2 essieux Zgkk, « Agipgas », ép. IV

FS, set de 2 wagones cisterna de gas de 2 ejes Zgkk, «Agipgas», ép. IV

FS, 2-unit set of 2-axle gas tank wagons, "Agipgas", ep. IV



Assi sostitutivi per corrente alternata: HC6101 (11.27 x 24.25 mm)



HR6621

IV

242

K

FS

**NEW**

**FS, set di 2 carri cisterna a 2 assi per trasporto gas, livrea argento, "Pibigas", ep. IV**

FS, 2-tlg. Set 2-achs. Gaskesselwagen in silberner Farbgebung, „Pibigas“, Ep. IV

FS, coffret de 2 wagons citernes à 2 essieux à gaz, livrée argent, « Pibigas », ép. IV

FS, set de 2 wagones cisternas, decoración plata, «Pibigas», ép. IV

FS, 2-unit set of 2-axle gas tank wagons, silver livery, "Pibigas", ep. IV



Assi sostitutivi per corrente alternata: HC6101 (11.27 x 24.25 mm)

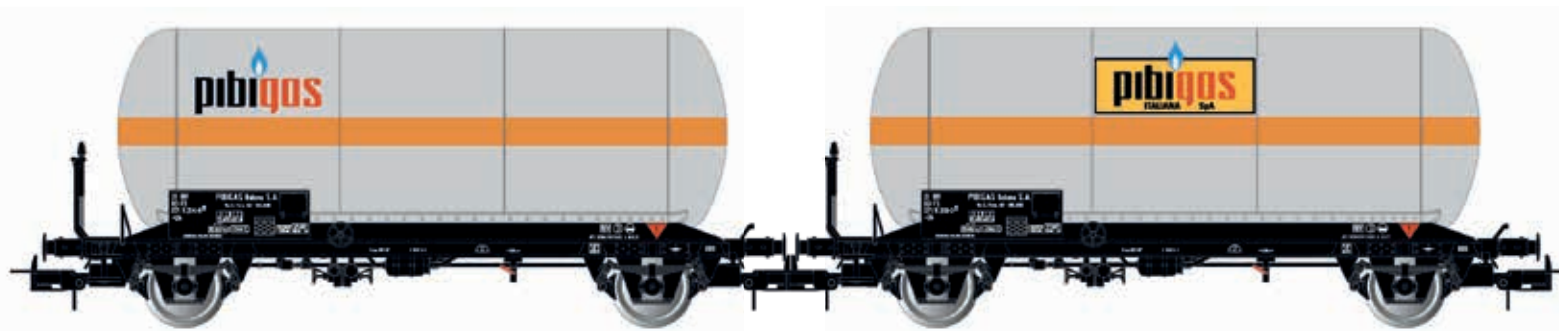





HR6618 **IV-V** <sup>242</sup><sub>← →</sub> **K** **DB**

**NEW**

**DB, set di 2 carri cisterna a 2 assi Zgs per trasporto gas, "BASF", ep. IV-V**

DB, 2-tlg. Set 2-achs. Gaskesselwagen Zgs, „BASF“, Ep. IV-V  
DB, coffret de 2 wagons citernes à 2 essieux Zgs à gaz, « BASF », ép. IV-V  
DB, set de 2 wagons cisternas de 2 ejes Zgs, «BASF», ép. IV-V  
DB, 2-unit set of 2-axle gas tank wagons Zgs, "BASF", ep. IV-V

Assi sostitutivi per corrente alternata: HC6101 (11.27 x 24.25 mm)



HR6619 **V** <sup>242</sup><sub>← →</sub> **K** **DB**

**NEW**

**DB, set di 2 carri cisterna a 2 assi Zgkk con tetto apribile, "VTG", ep. V**

DB, 2-tlg. Set 2-achs. Gaskesselwagen mit Sonnenschutzdach, „VTG“, Ep. V  
DB, coffret de 2 wagons-citernes à gaz à 2 essieux Zgkk avec toit ouvrant, « VTG », ép. V  
DB, set de 2 wagons cisterna de gas de 2 ejes Zgkk con techo solar, «VTG», ép. V  
DB, 2-unit set of 2-axle gas tank wagons with sun roof, "VTG", ep. V

Assi sostitutivi per corrente alternata: HC6101 (11.27 x 24.25 mm)



HR6622 **V** <sup>242</sup><sub>← →</sub> **K** **SBB**

**NEW**

**SBB, set di 2 carri cisterna a 2 assi per trasporto gas, "Wascosa", ep. V**

SBB, 2-tlg. Set 2-achs. Gaskesselwagen, „Wascosa“, Ep. V  
SBB, coffret de 2 wagons citernes à 2 essieux à gaz, « Wascosa », ép. V  
SBB, set de 2 wagons cisterna de 2 ejes, «Wascosa», ép. V  
SBB, 2-unit set of 2-axle gas tank wagons, "Wascosa", ep. V

Assi sostitutivi per corrente alternata: HC6101 (11.27 x 24.25 mm)



  
HR6646VI   

TRANSFESA

**NEW****TRANSFESA/Hispanauto, carro trasporto auto a 3 assi tipo Laeks "Mega Car Carrier", livrea argento, ep. VI**

TRANSFESA/Hispanauto, dreiachsiger Autotransportwagen der Bauart Laeks „Mega Car Carrier“, silberne Farbgebung, Ep. VI

TRANSFESA/Hispanauto, wagon porte-autos à 3 essieux Laeks « Mega Car Carrier », livrée argent, ép. VI

TRANSFESA/Hispanauto, vagón portacoche tipo Laeks "Mega Car Carrier", decoración azul/plata, ép. VI

TRANSFESA/Hispanauto, 3-axle car transporter Laeks "Mega Car Carrier", silver livery, ep. VI

Assi sostitutivi per corrente alternata: HC6103

  
HR6600IV-V   

FS

**FS, carro articolato a 3 assi telonato tipo Lails, "Ausiliare Milano", ep. IV-V**

FS, dreiachsiger Schiebepflanwagen Lails, „Ausiliare Milano“, Ep. IV-V

FS, wagon bâché à 3 essieux type Lails, « Ausiliare Milano », ép. IV-V

FS, vagón articulado entoldado tipo Lails de 3 ejes, "Ausiliare Milano", ép. IV-V

FS, 3-axle tarpaulin wagon Lails, "Ausiliare Milano", ep. IV-V

Assi sostitutivi per corrente alternata: HC6103





**HR6601** **V** **304** **K** **FS**

**FS, carro articolato a 3 assi telonato tipo Lails, "Indesit", ep. V**

FS, dreiaxssiger Schiebepplanenwagen Lails, „Indesit“, Ep. V  
FS, wagon bâché à 3 essieux type Lails, « Indesit », ép. V  
FS, vagón articulado entoldado tipo Lails de 3 ejes, "Indesit", ép. V  
FS, 3-axle tarpaulin wagon Lails, "Indesit », ep. V

Assi sostitutivi per corrente alternata: HC6103



**HR6602** **V** **304** **K** **FS**

**FS, carro articolato a 3 assi telonato tipo Lails, "Indesit + Ariston + Scholtès", ep. V**

FS, dreiaxssiger Schiebepplanenwagen Lails, „Indesit + Ariston + Scholtès“, Ep. V  
FS, wagon bâché à 3 essieux type Lails, « Indesit + Ariston + Scholtès », ép. V  
FS, vagón articulado entoldado tipo Lails de 3 ejes, "Indesit + Ariston + Scholtès", ép. V  
FS, 3-axle tarpaulin wagon Lails, "Indesit + Ariston + Scholtès », ep. V

Assi sostitutivi per corrente alternata: HC6103



**HR6603** **V** **304** **K**

**Carro articolato a 3 assi telonato tipo Lails, "Delacher + Co", ep. V**

Dreiaxssiger Schiebepplanenwagen Lails, „Delacher + Co“, Ep. V  
Wagon bâché à 3 essieux type Lails, « Delacher + Co », ép. V  
Vagón articulado entoldado tipo Lails de 3 ejes, "Delacher + Co", ép. V  
3-axle tarpaulin wagon Lails, "Delacher + Co », ep. V

Assi sostitutivi per corrente alternata: HC6103







© Gary Everhart



HR2950/HR2950S



Chesapeake & Ohio

**NEW**

### Chesapeake & Ohio, locomotiva a vapore articolata 2-6-6-6 "Allegheny", n. 1601

Chesapeake & Ohio, schwere Güterzugdampflokomotive der Bauart 2-6-6-6 „Allegheny“, Betriebsnummer 1601

Chesapeake & Ohio, locomotive à vapeur articulée 2-6-6-6 « Allegheny », #1601

Chesapeake & Ohio, locomotora de vapor articulada 2-6-6-6 "Allegheny" 1601

Chesapeake & Ohio, articulated steam locomotive 2-6-6-6 "Allegheny", #1601



- Con forno illuminato (DC) o scoppiettante (in digitale)
- Mit glühender (DC) bzw. flackerner (im Digitalbetrieb) Feuerbüchse
- Avec boîte à feu lumineuse (DC) ou scintillant (en mode digital)
- Con fogón iluminado (DC) o parpadeando (en modo digital)
- With glowing (DC) or flickering (in digital mode) firebox

196



HR2951/HR2951S



Chesapeake & Ohio

**NEW**

**Chesapeake & Ohio, locomotiva a vapore articolata 2-6-6-6 "Allegheny", n. 1632**

Chesapeake & Ohio, schwere Güterzugdampflokomotive der Bauart 2-6-6-6 „Allegheny“, Betriebsnummer 1632

Chesapeake & Ohio, locomotive à vapeur articulée 2-6-6-6 « Allegheny », #1632

Chesapeake & Ohio, locomotora de vapor articulada 2-6-6-6 "Allegheny" 1632

Chesapeake & Ohio, articulated steam locomotive 2-6-6-6 "Allegheny", #1632



- Con forno illuminato (DC) o scoppiettante (in digitale)
- Mit glühender (DC) bzw. flackerner (im Digitalbetrieb) Feuerbüchse
- Avec boîte à feu lumineuse (DC) ou scintillant (en mode digital)
- Con fogón iluminado (DC) o parpadeando (en modo digital)
- With glowing (DC) or flickering (in digital mode) firebox



HR2952/HR2952S



Chesapeake & Ohio

**NEW**

**Chesapeake & Ohio, locomotiva a vapore articolata 2-6-6-6 "Allegheny", n. 1653**

Chesapeake & Ohio, schwere Güterzugdampflokomotive der Bauart 2-6-6-6 „Allegheny“, Betriebsnummer 1653

Chesapeake & Ohio, locomotive à vapeur articulée 2-6-6-6 « Allegheny », #1653

Chesapeake & Ohio, locomotora de vapor articulada 2-6-6-6 "Allegheny" 1653

Chesapeake & Ohio, articulated steam locomotive 2-6-6-6 "Allegheny", #1653



- Con forno illuminato (DC) o scoppiettante (in digitale)
- Mit glühender (DC) bzw. flackerner (im Digitalbetrieb) Feuerbüchse
- Avec boîte à feu lumineuse (DC) ou scintillant (en mode digital)
- Con fogón iluminado (DC) o parpadeando (en modo digital)
- With glowing (DC) or flickering (in digital mode) firebox

**HR3023****Union Pacific****NEW****Union Pacific, tender per olio combustibile “Centipede”, ad esempio per locomotive della serie 4000 “Big Boy”**

Union Pacific, „Centipede” Öltender, u.a. für Lokomotiven der Reihe 4000 „Big Boy”

Union Pacific, tender à carburant « Centipede », par exemple pour les locomotives de la série 4000 « Big Boy »

Union Pacific, tender de fuel “Ciempiés”, por ejemplo para locomotoras de la serie 4000 “Big Boy”

Union Pacific, “Centipede” fuel tender, among others for class 4000 locomotives “Big Boy”

**HR6661A****ATSF****NEW****ATSF, carro a porte scorrevoli “San Francisco Chief” senza passerella sul tetto, n. 12711**

ATSF, gedeckter Güterwagen mit Schiebetüren „San Francisco Chief” ohne Dachsteg, Betriebsnr. 12711

ATSF, wagon couvert à portes coulissantes « San Francisco Chief » sans passerelle de toit, n° 12711

ATSF, US Boxcar 12711, con pasarela de techo, decoración “San Francisco Chief”

ATSF, sliding door boxcar “San Francisco Chief” without roof walkway, #12711

**Other running numbers available under the following references:**

HR6661B: ATSF, sliding door boxcar “San Francisco Chief” without roof walkway, #12712

HR6661C: ATSF, sliding door boxcar “San Francisco Chief” without roof walkway, #12746

HR6661D: ATSF, sliding door boxcar “San Francisco Chief” without roof walkway, #12755

Assi sostitutivi per corrente alternata: (9.60 x 26.00 mm)

**HR6662A****ATSF****NEW****ATSF, carro a porte scorrevoli “Texas Chief” senza passerella sul tetto, n. 12801**

ATSF, gedeckter Güterwagen mit Schiebetüren „Texas Chief” ohne Dachsteg, Betriebsnr. 12801

ATSF, wagon couvert à portes coulissantes « Texas Chief » sans passerelle de toit, n° 12801

ATSF, US Boxcar 12801, sin pasarela de techo, decoración “Texas Chief”

ATSF, sliding door boxcar “Texas Chief” without roof walkway, #12801

**Other running numbers available under the following references:**

HR6662B: ATSF, sliding door boxcar “Texas Chief” without roof walkway, #12821

HR6662C: ATSF, sliding door boxcar “Texas Chief” without roof walkway, #12844

HR6662D: ATSF, sliding door boxcar “Texas Chief” without roof walkway, #12850

Assi sostitutivi per corrente alternata: (9.60 x 26.00 mm)





**HR6663A****P&LE****NEW****P&LE, carro con portelloni ad espulsione/scorrevoli, livrea blu chiaro senza passerella sul tetto, n. 6458**

P&amp;LE, gedeckter Güterwagen mit Schwenkschiebetüren, hellblaue Farbgebung ohne Dachsteg, Betriebsnr. 6458

P&amp;LE, wagon couvert, portes coulissantes-pivotantes, livrée bleu clair sans passerelle de toit, n° 6458

P&amp;LE, US Boxcar 6458, decoración azul claro

P&amp;LE, plug door boxcar, light blue livery without roof walkway, #6458

**Other running numbers available under the following references:**

HR6663B: P&amp;LE, plug door boxcar, light blue livery without roof walkway, #6450

HR6663C: P&amp;LE, plug door boxcar, light blue livery without roof walkway, #6499

HR6663D: P&amp;LE, plug door boxcar, light blue livery without roof walkway, #6467

**HR6664A****Erie Lackawanna****NEW****Erie Lackawanna, carro con portelloni ad espulsione/scorrevoli, con passerella sul tetto, n. 68398**

Erie Lackawanna, gedeckter Güterwagen mit Schwenkschiebetüren und Dachsteg, Betriebsnr. 68398

Erie Lackawanna, wagon couvert, portes coulissantes-pivotantes, avec passerelle de toit, n° 68398

Erie Lackawanna, US Boxcar 68398, con pasarela de techo

Erie Lackawanna, plug door boxcar, with roof walkway, #68398

**Other running numbers available under the following references:**

HR6664B: Erie Lackawanna, plug door boxcar, with roof walkway, #68439

HR6664C: Erie Lackawanna, plug door boxcar, with roof walkway, #68360

HR6664D: Erie Lackawanna, plug door boxcar, with roof walkway, #68386

Assi sostitutivi per corrente alternata: (9.60 x 26.00 mm)

**HR6665A****Northern Pacific****NEW****Northern Pacific, carro con portelloni ad espulsione/scorrevoli, livrea verde senza passerella sul tetto, n. 98111**

Northern Pacific, gedeckter Güterwagen mit Schwenkschiebetüren, grüne Farbgebung ohne Dachsteg, Betriebsnr. 98111

Northern Pacific, wagon couvert, portes coulissantes-pivotantes, livrée verte sans passerelle de toit, n° 98111

Northern Pacific, US Boxcar 98111, decoración verde

Northern Pacific, plug door boxcar, green livery without roof walkway, #98111

**Other running numbers available under the following references:**

HR6665B: Northern Pacific, plug door boxcar, green livery without roof walkway, #98030

HR6665C: Northern Pacific, plug door boxcar, green livery without roof walkway, #98149

HR6665D: Northern Pacific, plug door boxcar, green livery without roof walkway, #98058

Assi sostitutivi per corrente alternata: (9.60 x 26.00 mm)



# Già disponibile • Schon verfügbar • Déjà disponible • Ya disponible • Already Available

*Certains produits annoncés comme encore « en stock » pourraient être déjà épuisés*

*Einige der hier als bereits verfügbar gekennzeichneten Produkte können bereits ab Lager ausverkauft sein.*

*I prodotti qui mostrati come disponibili potrebbero essere già esauriti.*

*Algunos de los productos marcados como ya disponibles podrían estar agotados ya.*

*Some items shown here as still available could already be sold out ex-works.*

## HR2787/HR2787S

FS, steam locomotive Gr. 835, oil lamps, riveted lateral water tanks, period III-IV



## HR2788/HR2888S

FS, steam locomotive Gr. 835, oil lamps, soldered lateral water tanks, period III-IV



## HR2789/HR2789S

FS, steam locomotive Gr. 835, electric lamps, big Westinghouse pump, period III-IV



## HR2790/HR2790S

FS, steam locomotive Gr. 835, electric lamps, big Westinghouse pump, period III-IV



## HR2807/HR2807S

KPEV, steam locomotive G 8.1, green/black livery, period I



## HR2808/HR2808S

DRG, steam locomotive class 55.25 (ex Pr. G 8.1), black/red livery, period II



## HR2809/HR2809S

DB, steam locomotive class 55.25 (ex Pr. G 8.1), black/red livery, period III



## HR2811

FS, steam locomotive Gr. 460, 3-dome boiler, oxide red/black livery, white markings, period II



## HR2917/HR2917S

FS, steam locomotive Gr. 835 with oil lamps, period III





**HR2918/HR2918S**

FS, steam locomotive Gr. 835 with electric lamps and white wheel rims, period III-IV



**HR2882/HR2882S**

Heisler Steam locomotive, 2-Truck model, "The Curtiss Lumber Co. #2", period III



**HR2883/HR2883S**

Heisler Steam locomotive, 2-Truck model, "Northern Redwood Lumber Company #4", period III



**HR2793/HR2793S**

FS, diesel locomotive class D.245, green livery with modern handrails, period V



**HR2794/HR2794S**

FS, diesel locomotive D.250 2001, orange livery, period V



**HR2795/HR2795S**

FS, diesel locomotive D.250 2001, orange livery, period V



**HR2796/HR2796/S**

FS, diesel locomotive D.250 2001, orange livery, period V-VI



**HR2877**

AGIP, shunting tractor ABL "Sogliola", yellow livery, with 2 2-axle tank wagons "Agip" livery, period III



**HR2897/HR2897S**

Mercitalia Shunting & Terminal, diesel shunting locomotive EffiShunter 1000, red/grey livery with white stripes, period VI



**HR2898/HR2898S**

Rail Traction Company, diesel shunting locomotive EffiShunter 1000, white/black livery, period VI



**HR2900/HR2900S**

Mercitalia Rail, diesel shunting locomotive EffiShunter 1000, silver livery with red stripes, period VI



**HR2928/HR2928S**

AWT, diesel locomotive class D.753.7, orange/grey livery, period V-VI





**HR2929/HR2929S**

HUPAC, diesel locomotive class D.753.7, red/light grey livery, period V-VI

**HR2930/HR2930S**

Mercitalia S&T, diesel locomotive class D.753, red/grey livery with white stripes, period VI

**HR2816S**

ÖBB, diesel locomotive 2050.08, vermilion livery, period IV-V, with DCC-Sounddecoder

**HR2818/HR2818S**

ÖBB, diesel locomotive 2050 005-4, traffic red livery, period IV-V

**HR2851/HR2851S**

ÖBB, diesel locomotive class 2050.002, with generator, green livery, period IV

**HR2797/HR2797D**

FS, electric locomotive E.652 108, silver/red "FS Mercitalia" livery, period IV

**HR2867/HR2867S**

FS, electric locomotive E.646, 2nd series, green/grey livery with aluminium stripes, period IIIb

**HR2868S**

FS, electric locomotive E.646, 2nd series, "Treno Azzurro" livery, period IIIb, with DCC-sounddecoder

**HR2871/HR2871S**

FS, electric locomotive E.646, 2nd series, "Navetta" MDVC livery and dark grey roof, period IVb

**HR2873/HR2873S**

FS, electric locomotive E.424, castano/isabella livery, period IV

**HR2874/HR2874S**

FS, electric locomotive E.424, isabella livery, period V

**HR2875/HR2875S**

FS, 2-unit set electric locomotives E.633 200 series, blue/grey livery, period IV-V



**HR2876/JR2876S**

FS, electric locomotive E.632 with pantographs 52, blue/grey livery with FS "a losanga" logo, period V

**HR2902/HR2902S**

FS, electric locomotive E.428, semi-aerodynamic design, driving wheels with original transmission, period IVa

**HR2904/HR2904S**

FS, electric locomotive E.402B, new "Frecciabianca" livery, ep. VI

**HR2905/HR2905S**

FS RFI, electric locomotive E.402B, yellow/blue livery, period VI

**HR2699D**

FS, electric locomotive class E.652 004 prototype, with type 52 pantograph, original livery, period IV-V

**HR2701D**

FS, electric locomotive class E.652 088, original livery with big running number on the frontal sides, period IV-V

**HR2854/HR2854S**

ÖBB, electric locomotive 1046 009-5, "Valousek" livery, period IV-V

**HR2855/HR2855S**

ÖBB, electric locomotive 4061.17, vermillion livery, period IV

**HR2856/HR2856S**

ÖBB, electric locomotive 1046 001-2, red/grey livery, period V

**HR2819D/HR2819S**

ÖBB, electric locomotive class 1040, green livery, period III-IV

**HR2820D/HR2820S**

ÖBB, electric locomotive class 1040, vermillion livery with old logo, period IV

**HR2853S**

DB, electric locomotive E 33 020, green livery, period III-IV





**HR4286**

FS, 2-unit set of coaches UIC-Z renovated (progetto 901/300), XMPR livery, including 1 2nd class (ex 1st class) coach and 1 2nd class coach, period VI

**HR4351**

FS, 2-unit set of 1st class coaches Gran Confort '85 "Progetto 901", "Frecciabianca" livery with red doors, period VI

**HR4355**

FS, 2-unit set of 2nd class coaches UIC-Z1 "Progetto 901", "Frecciabianca" livery with red doors, period VI

**HR4363**

FS, luggage van UIC-X '70 with large fairings, grey livery, ep. IV

**HR4318**

FS, 3-unit set "Celerone", including 1 x Ulz 1400 mail van in grey livery, 1 x DUz 93100 luggage/mail van in grey livery and 1 x closed wagon Hcs-uvvy with bellows, period IV

**HR4353**

FS, 2-units set of Gran Confort 1985 open space coaches, "Bandiera" livery, including 1 coach A and 1 coach AH with handicap seats, period V

**HR4357**

FS, 2-units pack UIC-Z1 rebuilt 2nd class, Intercity Notte Basic livery blue with red stripe, ep. VI

**HR4369**

FS, 3-unit set of 2-axle "Corbellini" 1947 3rd class coaches for historic trains, castano/Isabella livery, period V-IV

**HR4324**

FS, 4-unit set of "Treno Azzurro" coaches, including 2 1st class Type 1946 Az13025 coaches and 2 2nd class Type 1946 Bz33010 coaches, one with "ristoro" compartment, period IIIb

**HR4354**

FS, 2-units set of Gran Confort 1985 open space coaches, XMPR livery, including 1 coach A and 1 coach AH with handicap seats, period V-VI

**HR4358**

FS, 3-unit set of IC 572/579 coaches "Petruzzelli", Milan - Bari, "Bandiera" livery, including 1 salon coach Gran Confort 1985, 1 coach with compartments Gran Confort 1985 and 1 restaurant coach Gran Confort WR83 with smooth roof, period V

**HR4370**

FS, 2-unit set of "Corbellini" 1947 coaches, grey livery, including 1 2-axle coach and 1 4-axle coach, period IV





**HR4333**

CIWL, sleeping coach MU '64 WMD, matriculated in the fleet of the DB, period IV

**HR4334**

SBB, sleeping coach MU '64 WMD with big skirts, TEN livery with aluminium roof, period IV

**HR4335**

SBB, sleeping coach MU '68, "Mond und Sterne" livery, period V

**HR4301**

ÖBB, sleeping coach MU, "TEN" livery with blue roof, period IV-V

**HR4302**

DB, sleeping coach MU, "TEN" livery with aluminium roof, period IV

**HR4293**

ALEX, 3-unit pack passenger coaches type UIC-Z, 2nd class in grey/white livery, period VI

**HR4305**

3-unit pack "TEE Helvetia", ARD+mh<sup>105</sup>, Apümh<sup>121</sup> and Avümh<sup>111</sup>

**HR4306**

3-unit pack "TEE Helvetia" Hamburg-Zürich, WRmh<sup>132</sup> DB + 2 Avmz<sup>111</sup> DB, TEE livery, ep. IV

**HR4327**

DR, 3-unit set of coaches, green livery, including 1 1st class coach, 1 1st/2nd class coach and 1 sleeperette coach, period III

**HR4328**

DR, 3-unit set of coaches, including 2 2nd class coaches in green livery and 1 Mitropa restaurant coach, period III

**HR4344**

DR, 3-unit set of OSShD Type B coaches, beige/green livery, including 1 1st class coach A, 1 1st/2nd class coach AB and 1 2nd class coach Bc, period IV

**HR4345**

DR, 3-unit set of OSShD Type B coaches, including 2 2nd class coach B in beige/green livery and 1 restaurant coach WR in red livery, period IV



**HR4371**

DR, 4-unit of double-decker coaches without cab-control unit, blue/light grey livery, period IV

**HR4372**

DR, 2-unit of double-decker coaches with cab-control unit, blue/light grey livery, period IV

**HR4379**

DR, 4-unit set of OSShD type B coaches "Tourex", red livery, including 2 coaches WLAB, 1 coach WLABD and 1 coach WR, period IV

**HR6480**

DB, 2-axle closed wagon Gmhs, "MAK", period III

**HR6495**

BR, 4-axle tarpaulin wagon, red "Railfreight Metal" livery, period IV

**HR6496**

BR, 4-axle tarpaulin wagon, blue "Easiloader" livery, period IV

**HR6497**

BR, 4-axle tarpaulin wagon, blue "Cargowaggon" livery, period IV

**HR6502**

ERR, 4-axle flat wagon Sg, brown livery, loaded with 2 20' container "CMA CGM", period VI

**HR6503**

DB, 2-axle closed wagon Gmhs 55 with rear light, period III

**HR6504**

DR, 2-axle closed wagon Gs with rear light, period IV

**HR6505**

FS, 2-unit set of closed wagons Gs with flat walls, brown livery, period IV-V

**HR6506**

FS, 2-unit set of closed wagons Gs with flat walls, brown livery, FS "a losanga" logo, period IV-V



 **HR6507**

FS, 2-unit set of closed wagons Ghs with low aerators, brown livery, period IV-V



 **HR6508**

FS, 2-unit set of service wagons, brown and light grey livery, including 1 x VGs wagon with flat walls and 1 x VGhs wagon with low aerators, period V



 **HR6511**

FS, 2-unit set of 4-axle gas tank wagons Zagkks, "ermewa Autogas" + "Autogas", with orange stripe, period V



 **HR6512**

VTG, 2-unit set of 4-axle gas tank wagons Zags for vinyl chloride transport, grey livery with orange stripe, period V



 **HR6513**

FS, 2-unit set of 4-axle tank wagons Zags/Zas, white livery with and without orange stripe, "Sogetank", period V



 **HR6516**

FS, 4-axle tank wagon Zaes, silver/blue livery, "Montedison", period IV



 **HR6517**

FS, 3-unit set of 2-axle tank wagons VZekk, 27 m³ tank, silver livery with black stripe, period IV-V



 **HR6518**

FS, 2-unit set of 2-axle tank wagons Mop, 27 m³ tank, silver silvery, "Shell", period III



 **HR6519**

FS, 2-unit set of 2-axle tank wagons Md, 27 m³ tank, "Montecatini", period III



 **HR6548**

NACCO, 4-axle tank wagon Zans, blue livery, "Amberger Kaolinwerke", period VI



 **HR6549**

ERMEWA, 4-axle tank wagon Zaens, silver/white livery, "Hoyer", period VI



 **HR6520**

DB AG, 3-unit set of 4-axle self-discharging wagons Fals 164, brown livery, period V







### HR6521

DR, 3-unit set of 4-axle self-discharging wagons Fal-zz, brown livery, period IV



### HR6551

FS, 3-units pack refrigerated wagons Hgb 2-axes (2 without brakeman's cab, 1 with), white, red stripe, UK loading gauge, ep. III



### HR6562

FS, 2-units pack refrigerated wagons Ifms 2-axes without brakeman's cab, metallic doors, white, red stripe, UK loading gauge, ep. IV



### HR6563

FS, 2-units pack refrigerated wagons Ifms 2-axes without brakeman's cab, metallic doors, white, red stripe, UK loading gauge, ep. IV



### HR6569

FS, 3-axle tarpaulin wagon Las, blue livery, "Ausiliare", period IV



### HR6570

FS, 3-axle tarpaulin wagon Lails, grey livery, "Inesit", period V



### HR6572

FS, 4-axle tank wagon Us, blue livery, "Ausiliare", period IV



### HR6573

FS, 2-axle silo wagon, blue livery, "Ausiliare", period IV



### HR6574

DB, 2-unit set of silo wagons Ucs, grey livery, "Höchst", period IV



### HR6576

FS CEMAT, 4-axle container wagon Sgnss, brown livery, loaded with 45' container "Trenitalia", period V-VI



### HR6578

4-axle container wagon Sgnss, green livery, loaded with 45' container "Warsteiner", period V-VI



### HR6591

DB, 2-unit set of silo wagons Ucs, grey livery, "Dyckerhoff", period IV





### HR6592

DR-Miet, 2-unit set of silo wagons Ucs, grey and blue livery, "VTG", period IV



### HR6604

FS, 2-unit set of 2-axle refrigerated wagons lfms with metallic doors, UK loading gauge, silver livery with red stripe, period IV



### HR6605

FS, 3-unit set of 2-axle refrigerated wagons Hgb (2 without brakeman's cab, 1 with), UK loading gauge, silver livery with red stripe, period III



### HR6606

FS, 2-unit set of 2-axle refrigerated wagons Hgb, metallic body, UK loading gauge, silver livery, "Cinzano", period III



### HR6607

FS, 2-unit of 2-axle tank wagons (1 without brakeman's cab, 1 with), "Mobil", period III



### HR6608

ÖBB, 2-axle tank wagon (ex FS), dark grey livery, "ÖMV", period III



### HR6609

ÖBB, 2-axle tank wagon (ex FS), dark grey livery, "ÖROP", period III



### HR6610

FS, 2-axle closed wagon Gs with flat walls, "Coca-Cola", period IV



### HR6611

DB, 2-axle closed wagon Gs with flat walls, "Coca-Cola", period IV



### HR6613

CEMAT, 4-axle container wagon Sgnss, green livery, new CEMAT logo, with 45' container "nothegger", ep. VI



### HR6614

Mercitalia Intermodal, 4-axle 2-unit pack Sgnss container wagons, blue livery, with 45' containers "P&O Ferrymasters" (blue and yellow), ep. VI



### HR6615

FS CEMAT, 4-axle container wagon Sgnss, loaded with 2 20' coil containers "Nizzi", period V-VI





### HR6616

FS CEMAT, 4-axle container wagon Sgns, green livery, loaded with 2 20' coil containers "Dani Trasporti", period V-VI



### HR6617

FS CEMAT, 4-axle container wagon Sgns, green livery, loaded with 45' container "Italia", period V-VI



### HR6634B

Great Northern, US-Boxcar, running number 36829, period III



### HR6636C

Canadian Pacific, US-Boxcar with roof walkaway "Newsprint Service Only", running number 80920, period III



### HC8061

Locomotive shed one place (without door)



### HC8059

Small railway station with good shed and high platform



### HC8062

Small toilet



### HC8060

Water Tank with small depot below







# Indice • Index

Locomotive elettriche . . .	.214
Carrozze . . . . .	.220
Prodotti disponibili . . . .	.222

<i>Electric locomotives . . . .</i>	<i>214</i>
<i>Coaches . . . . .</i>	<i>220</i>
<i>Available Products . . . . .</i>	<i>222</i>

## LimaEXPERT®

LIMA è tra i più importanti marchi nel mondo del modellismo ferroviario sin dal 1946. Dieci anni fa è nata LIMA Expert, la linea di prodotti per gli appassionati di modellismo ferroviario esperti ed esigenti che hanno un occhio di riguardo anche per il budget riservato all'hobby.

Con i treni ad alta velocità ICE1 delle Ferrovie Tedesche in diverse versioni, gli elettrotreni ETR 610, le locomotive elettriche E464 e le carrozze a due piani Vivalto di Trenitalia ci siamo posti l'obiettivo di ricreare lo spirito storico del marchio, attento alle novità del mondo reale ed alla "modernità", non soltanto per il mercato italiano ma con un respiro internazionale, come è sempre stato per LIMA.

Questi modelli sono quindi dettagliati, fedeli al vero e con livree attraenti, ma allo stesso tempo robusti e "senza fronzoli", orientati al gioco ed al divertimento, caratteristiche che accomunano tutte le riproduzioni del marchio.

LIMA Expert ti introduce nel migliore dei modi nell'affascinante mondo del fermodellismo!



[www.limamodel.com](http://www.limamodel.com)









HL1750

IV-V

MEM

1078

← →

⚡

Ⓚ

⚙️

⚙️

DB

**DB, set di 4 unità, elettrotreno ad alta velocità ICE 1 BR 401, livrea bianca/rossa, composto da locomotiva motorizzata, locomotiva folle e 2 carrozze intermedie, ep. IV-V**

DB, 4-tlg. Set elektrischer Triebzug Baureihe 401 (ICE 1) in weiß/roter Lackierung, bestehend aus 2 Triebköpfen (einer davon angetrieben) sowie 2 Zwischenwagen, Ep. IV-V

DB, coffret de 4 unités, automotrice électrique ICE 1 BR 401, livrée blanche/rouge, composé de locomotive motorisé, locomotive sans motor et 2 voitures, ép. IV-V

DB, set de 4 unidades, automotor eléctrico clase 401 ICE 1, decoración blanca/roja, compuesto de locomotora motorizada, locomotora sin motor y 2 coches intermedios, ép. IV-V

DB, 4-unit set, highspeed EMU ICE 1 class 401, white/red livery, including motorized head, dummy head and 2 intermediate coaches, period IV-V



**Start der Bundesbahn ins Hochgeschwindigkeitszeitalter**

1992 begann mit dem Sommerfahrplan bei der DB das Zeitalter des ICE-Linienverkehrs. Mit ihrer Höchstgeschwindigkeit von 280 km/h und 9600 kW Dauerleistung gehörten sie damals schon zu den Stars auf den Schienen. Bald waren die eleganten Züge zwischen Hamburg und Stuttgart/München und zwischen Köln und Berlin alltäglich anzutreffen. Später verkehrten sie darüber hinaus bis nach Wien oder auch nach Zürich/Interlaken, wobei sie für letztere Ziele mit zusätzlichen Stromabnehmern nach Schweizer Vorschriften auf den Triebköpfen und auch mit den Schweizer Sicherungssystemen ausgerüstet wurden. Nach 1998 änderte sich das Erscheinungsbild geringfügig, wurde doch der Rotton des Zierstreifens von Orientrot zu Verkehrsrot geändert und der pastellviolette Streifen entfiel. Heute sind einige dieser Züge mit grünen Zierstreifen am Triebkopf unterwegs. Mittlerweile haben nach fast 30 Einsatzjahren die Züge mehrere Millionen Kilometer „auf der Uhr“, aber derzeitigen Planungen zu Folge, werden diese Züge auch nach 2030 noch im Einsatz bleiben.

**HL4674**

IV-V

908

L

K

DB

**DB, set di 3 carrozze aggiuntive ICE 1 BR 401, livrea bianca/rossa, composto da 1 carrozza ristorante e 2 carrozze di 2a classe, ep. IV-V**

DB, 3-tlg. Set Ergänzungsset ICE 1 Baureihe 401 in weiß/roter Lackierung, bestehend aus 1 x Speisewagen und 2 x 2.-Klasse-Wagen, Ep. IV-V

DB, coffret de 3 voitures supplémentaires ICE 1 BR 401, livrée blanche/rouge, composé de 1 voiture restaurant et 2 voitures de 2ème classe, ép. IV-V

DB, set de 3 coches adicionales ICE 1 BR 401, decoración blanca/roja, compuesto de 1 coche restaurante y 2 coches de segunda clase, ép. IV-V

DB, 3-unit set of additional coaches ICE 1 BR 401, white/red livery, including 1 restaurant coach and 2 2nd class coaches, period IV-V

**HL4677**

IV-V

606

L

K

DB

**DB, set di 2 carrozze aggiuntive ICE 1 BR 401, livrea bianca/rossa, composto da 1 carrozza di 1a classe e 1 carrozza di 2a classe, ep. IV-V**

DB, 2-tlg. Set Ergänzungsset ICE 1 Baureihe 401 in weiß/roter Lackierung, bestehend aus 1 x 1.-Klasse-Wagen und 1 x 2.-Klasse-Wagen, Ep. IV-V

DB, coffret de 2 voitures supplémentaires ICE 1 BR 401, livrée blanche/rouge, composé de 1 voiture de 1ère classe et 1 voiture de 2ème classe, ép. IV-V

DB, set de 2 coches adicionales ICE 1 BR 401, decoración blanca/roja, compuesto de 1 coche de primera clase y 1 coche de primera clase, ép. IV-V

DB, 2-unit set of additional coaches ICE 1 BR 401, white/red livery, including 1 1st class coach and 1 2nd class coach, period IV-V





HL1751



DB AG

**DB AG, set di 4 unità, elettrotreno ad alta velocità ICE 1 BR 401, livrea bianca/rossa, composto da locomotiva motorizzata, locomotiva folle e 2 carrozze intermedie, Tz 157 "Landshut", ep. VI**

DB AG, 4-tlg. Set elektrischer Triebzug Baureihe 401 (ICE 1) in weiß/roter Lackierung, bestehend aus 2 Triebköpfen (einer davon angetrieben) sowie 2 Zwischenwagen, Tz 157 „Landshut“, Ep. VI

DB AG, coffret de 4 unités, automotrice électrique ICE 1 BR 401, livrée blanche/rouge, composé de locomotive motorisé, locomotive sans motor et 2 voitures, Tz 157 « Landshut », ép. VI

DB AG, set de 4 unidades, automotor eléctrico clase 401 ICE 1, decoración blanca/roja, compuesto de locomotora motorizada, locomotora sin motor y 2 coches intermedios, locomotoras y coches intermedios, Tz 157 «Landshut», ép. VI

DB AG, 4-unit set, highspeed EMU ICE 1 class 401, white/red livery, including motorized head, dummy head and 2 intermediate coaches, Tz 157 "Landshut", period VI



**Das neue LIMA-Expert-Modell im Detail**

- Triebköpfe und Zwischenwagen exakt im Maßstab 1:87
- Kurzkupplungsdeichseln mit funktionsfähigen Scharfenberg-Kupplungen tauschbar (Art.-Nr. HC8040)
- Kräftiger Fünfpolmotor mit Schwungmassen
- Spitzenlicht und Schlusslichter je nach Fahrtrichtung beleuchtet
- Führerstände und Zwischenwagen mit Inneneinrichtung
- Digitalschnittstelle: 21-pol MTC (NEM 660)
- Vorbereitet für den Einbau eines Rechtecklautsprechers (15x11 mm) ohne Löten
- Mindestradius: 356,5 mm (fährt jedoch besser in großzügigeren Kurvenradien)



Feine Stromabnehmer, größtenteils aus Metall gefertigt





HL4675 VI     DB AG

**DB AG, set di 3 carrozze aggiuntive ICE 1 BR 401, livrea bianca/rossa, composto da 1 carrozza ristorante e 2 carrozze di 2a classe, Tz 157 "Landshut", ep. VI**

DB AG, 3-tlg. Set Ergänzungsset ICE 1 Baureihe 401 in weiß/roter Lackierung, bestehend aus 1 x Speisewagen und 2 x 2.-Klasse-Wagen, Tz 157 „Landshut“, Ep. VI

DB AG, coffret de 3 voitures supplémentaires ICE 1 BR 401, livrée blanche/rouge, composé de 1 voiture restaurant et 2 voitures de 2ème classe, Tz 157 « Landshut », ép. VI

DB AG, set de 3 coches adicionales ICE 1 BR 401, decoración blanca/roja, compuesto de 1 coche restaurante y 2 coches de segunda clase, Tz 157 «Landshut», ép. VI

DB AG, 3-unit set of additional coaches ICE 1 BR 401, white/red livery, including 1 restaurant coach and 2 2nd class coaches, Tz 157 "Landshut", period VI



HL4678 VI     DB AG

**DB AG, set di 2 carrozze aggiuntive ICE 1 BR 401, livrea bianca/rossa, composto da 1 carrozza di 1a classe e 1 carrozza di 2a classe, Tz 157 "Landshut", ep. VI**

DB AG, 2-tlg. Set Ergänzungsset ICE 1 Baureihe 401 in weiß/roter Lackierung, bestehend aus 1 x 1.-Klasse-Wagen und 1 x 2.-Klasse-Wagen, Tz 157 „Landshut“, Ep. VI

DB AG, coffret de 2 voitures supplémentaires ICE 1 BR 401, livrée blanche/rouge, composé de 1 voiture de 1ère classe et 1 voiture de 2ème classe, Tz 157 « Landshut », ép. VI

DB AG, set de 2 coches adicionales ICE 1 BR 401, decoración blanca/roja, compuesto de 1 coche de primera clase y 1 coche de primera clase, Tz 157 «Landshut», ép. VI

DB AG, 2-unit set of additional coaches ICE 1 BR 401, white/red livery, including 1 1st class coach and 1 2nd class coach, Tz 157 "Landshut", period VI





HL2663



FS Trenitalia

**FS Trenitalia, set di 2 locomotive elettriche E.464 (entrambe motorizzate), livrea "Frecciabianca", ep. VI**

FS Trenitalia, 2-tlg. Set Elektrolokomotiven E.464 (beide motorisiert) in „Frecciabianca“-Lackierung, Ep. VI  
FS Trenitalia, coffret de 2 locomotives électriques E.464 (tous deux motorisés), livrée « Frecciabianca », ép. VI  
FS Trenitalia, set de 2 locomotoras eléctricas E.464 (ambos motorizados), decoración «Frecciabianca»,ép. VI  
FS Trenitalia, 2-unit set of electric locomotives E.464 (both motorized), "Frecciabianca" livery, period VI



HL2664



FS Trenitalia

**FS Trenitalia, locomotiva elettrica E.464 464, livrea "Quattroseiquattro", ep. VI**

FS Trenitalia, Elektrolokomotive E.464 464 in „Quattroseiquattro“-Lackierung, Ep. VI  
FS Trenitalia, locomotive électrique E.464 464, livrée « Quattroseiquattro », ép. VI  
FS Trenitalia, locomotora eléctrica E.464 464, decoración «Quattroseiquattro», ép. VI  
FS Trenitalia, electric locomotive E.464 464, "Quattroseiquattro" livery, period VI





HL2665



FS Trenitalia

**FS Trenitalia, locomotiva elettrica E.464, livrea "Intercity", ep. VI**

FS Trenitalia, Elektrolokomotive E.464 in „Intercity“-Lackierung, Ep. VI

FS Trenitalia, locomotive électrique E.464, livrée « Intercity », ép. VI

FS Trenitalia, locomotora eléctrica E.464, decoración «Intercity», ép. VI

FS Trenitalia, electric locomotive E.464, "Intercity" livery, period VI



HL2667



FER

**FER, set di 2 automotrici diesel ALn 668 serie 1000, livrea FER, motorizzata + folle, ep. V-VI**

FER, 2-tlg. Set Dieseltriebwagen ALn 668 Serie 1000 in „FER“-Lackierung, 1 x motorisiert + 1 x unmotorisiert, Ep. V-VI

FER, coffret de 2 automoteurs ALn 668 série 1000, livrée FER, motorisé + neutre, ép. V-VI

FER, set de 2 unidades, automotor diesel ALn 668 serie 1000, decoración FER, motorizado + sin motor, ép. V-VI

FER, 2-unit set of diesel railcars ALn 668 series 1000, FER livery, motorized + dummy, period, period V-VI







HL5056

VI



920



← →



K



FS Trenitalia

**FS Trenitalia, set di 3 carrozze Vivalto, livrea DPR con vecchio logo Vivalto, composto da 1 carrozza pilota e 2 carrozze intermedie, ep. VI**

FS Trenitalia, 3-tlg. Set Vivalto in „DPR“-Lackierung mit altem „Vivalto“-Logo, bestehend aus 1 x Steuerwagen mit Führerstand und 2 x Zwischwagen, Ep. VI

FS Trenitalia, coffret de 3 voitures Vivalto, livrée DPR avec ancien logo « Vivalto », composé de 1 voiture pilote et voitures intermédiaires, ép. VI

FS Trenitalia, set de 3 coches Vivalto, decoración DPR con logo «Vivalto» antiguo, compuesto de 1 coche piloto e 2 coches intermedios, ép. VI

FS Trenitalia, 3-unit set of Vivalto coaches, DPR livery with old "Vivalto" logo, including 1 coach with driver's cab and 2 intermediate coaches, period VI



Fotomontage / Fotomontaje / Photomontage / Fotomontaggio



HL5057

VI



608



← →



K

FS Trenitalia

**FS Trenitalia, set di 2 carrozze intermedie Vivalto, livrea DPR con vecchio logo Vivalto, ep. VI**

FS Trenitalia, 2-tlg. Ergänzungssset Vivalto in „DPR“-Lackierung mit altem „Vivalto“-Logo, Ep. VI

FS Trenitalia, coffret de 2 voitures intermédiaires Vivalto, livrée DPR avec ancien logo « Vivalto », ép. VI

FS Trenitalia, set de 2 coches intermedios Vivalto, decoración DPR con logo «Vivalto» antiguo, ép. VI

FS Trenitalia, 2-unit set of Vivalto intermediate coaches, DPR livery with old "Vivalto" logo, period VI



Fotomontage / Fotomontaje / Photomontage / Fotomontaggio



HL5058

VI



920



L

K



FS Trenitalia

**FS Trenitalia, set di 3 carrozze Vivalto, livrea Vivalto con nuovo logo Vivalto, composto da 1 carrozza pilota e 2 carrozze intermedie, ep. VI**

FS Trenitalia, 3-tlg. Set Vivalto in „Vivalto“-Lackierung mit neuem „Vivalto“-Logo, bestehend aus 1 x Steuerwagen mit Führerstand und 2 x Zwischwagen, Ep. VI

FS Trenitalia, coffret de 3 voitures Vivalto, livrée Vivalto avec nouveau logo « Vivalto », composé de 1 voiture pilote et voitures intermédiaires, ép. VI

FS Trenitalia, set de 3 coches Vivalto, décoration Vivalto con logo «Vivalto» nuevo, compuesto de 1 coche piloto e 2 coches intermedios, ép. VI

FS Trenitalia, 3-unit set of Vivalto coaches, Vivalto livery with new "Vivalto" logo, including 1 coach with driver's cab and 2 intermediate coaches, period VI



Fotomontage / Fotomontaje / Photomontage / Fotomontaggio



Giovanni Lorusso



# Già disponibile • Schon verfügbar • Déjà disponible • Ya disponible • Already Available

**Certains produits annoncés comme encore « en stock » pourraient être déjà épuisés**

*Einige der hier als bereits verfügbar gekennzeichneten Produkte können bereits ab Lager ausverkauft sein.*

*I prodotti qui mostrati come disponibili potrebbero essere già esauriti.*

*Algunos de los productos marcados como ya disponibles podrían estar agotados ya.*

*Some items shown here as still available could already be sold out ex-works.*

## HL2655

Trenord, 2-unit set of diesel railcars ALn 668 series 1000, flat glasses, period VI



## HL2656

FSF, 2-unit set railcars ALn 668 light blue/grey livery, "Freccia Orobianca", curved glass, period IV



## HL2660

FS Trenitalia, electric locomotive E.464, XMPR livery, period VI



## HL2661

FS Trenitalia, electric locomotive E.464, DPR livery, epoca VI



## HL2662

Trenord, electric locomotive E.464, period VI



## HL1680

SBB, 4-unit base set EMU RABe 503 018 "Astoro", "ECE 190 München – Zürich", period VI



## HL4050

FS, 2nd class coach UIC-Z1, grey/white "Intercity Giorno" livery with red stripe, period VI



## HL4051

FS, 2nd class coach UIC-Z1, blue "Intercity Notte Basic" livery with red stripe, period VI



## HL5050

FS Trenitalia, 3-unit set of Vivalto coaches, "Vivalto" white livery with green/blue stripes, including 1 x driver's cab and 2 x intermediate coaches, period VI







**HL5053**

FS Trenitalia, 2-unit set of Vivalto intermediate coaches, "Vivalto" white livery with green/blue stripes, period VI



**HC5000**

Crepes Trailer



**HC5002**

Pizza Food Trailer



**HL5055**

Trenord, 2-unit set of Vivalto intermediate coaches, Trenord livery, period VI



**HC5001**

Bratwurst Food Trailer



**HC5003**

Paella Food Trailer



**HL8000**

**JUNIOR LINE**

Container Crane with 2 containers



## HC2104

### Ladegut: Betonschwellen für Wagen der Bauarten Rs, Res etc. - Maße: 199 x 28 mm

Cargaison : Traverses en béton pour wagons type Rs, Res etc. - Dimensions : 199 x 28 mm

Carico: Carico di traversine in calcestruzzo per carri tipo Res, Rgs e Rs etc. - Dimensioni: 199 x 28 mm

Carga: Traviesas de hormigón para vagones tipo Rs, Res, etc. - Dimensiones: 199 x 28 mm

Load: Concrete sleepers for wagons type Rs, Res etc. - Dimensions: 199 x 28 mm

### Betonschwellen

#### Ladegut für Wagen der Bauarten Rs, Res u.ä.

Da Holzschwellen aus einem teuren Rohstoff bestehen, wurde schon früh experimentiert, welche Materialien sich für die Unterkonstruktion eines Gleises noch bieten würden. Beton lässt sich leicht verarbeiten und bietet somit eine Reihe von Möglichkeiten der Formgestaltung. Die ersten Betonschwellen wurden bereits um 1890 eingeführt, in Deutschland begann die Erprobung von Schwellen aus Beton in den 1920er-Jahren. In größerem Umfang wurden sie allerdings erst ab 1949 gefertigt. Bei der Bundesbahn waren bis 1974 bereits 25 Millionen Betonschwellen verbaut. Der Transport erfolgt heute meist mit standardisierten Wagen der Typen Res, Rs o.ä.

Mit etwa 199 x 28 mm passt unser neues Ladegut auf fast alle HO-Modelle dieser Güterwagen. Unsere HEICO-Schwellen sind aus hochwertigem Resin gefertigt und alle einzeln handbemalt.

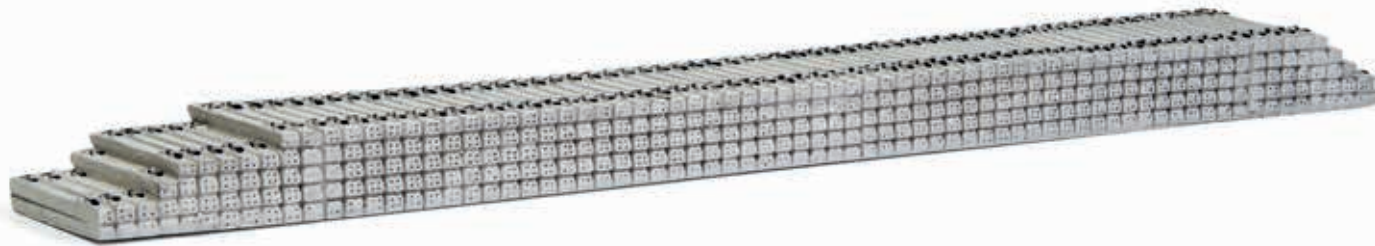

## HC2100

### Ladegut: 4 Oberklasse-Pkw in weißem Neuwagentransportschutz

Cargaison : 4 voitures de luxe recouvertes d'une bâche blanche

Carico: 4 auto di lusso coperte da telo bianco

Carga: 4 coches de lujo con protección de transporte de vehículo nuevo, blanco

Load: 4 luxury class cars with white transport cover



Je hochwertiger der Neuwagen desto besser wird es für den Transport per Bahn und Lkw verpackt. Seit einigen Jahren gibt es dafür sogar komplett geschlossene Autotransportwagen. Doch nicht alle Wagen sind so modern oder besitzen einen ausreichenden Transportschutz. Daher hat es sich bei einigen der namhaften Autohersteller aus dem württembergischen und bayerischen Raum eingebürgert, ihre Neufahrzeuge komplett in einen weißen, maßgeschneiderten Transportschutz zu hüllen. Sogar die Felgen sind dazu mit speziellen Radkappen abgedeckt. Um die so verhüllten Pkw damit trotzdem noch auf die Autotransportwagen fahren zu können, sind in den Transportschutz lediglich Fensterausschnitte eingenäht.

Unsere HEICO-Neuwagenmodelle sind komplett aus hochwertigem Resin gefertigt und passen mit **56 x 22 mm** (Höhe: 15 mm) in bzw. auf fast alle bekannten H0-Modelle von Autotransportwagen.

## HC2103

### Ladegut: Drahtrollen

Cargaison : bobines de fil

Carico: bobine

Carga: rollos

Load: wire coils



Stahldraht ist ein Erzeugnis der Stahlindustrie, das in großen Mengen in alle Welt versandt wird. Von den Stahlwerken aus werden Großkunden z.B. aus der Auto- oder Bauindustrie meist mit der Eisenbahn beliefert. Oft sind ganze Züge damit beladen und auf ihrem Weg quer durch Europa zu beobachten. Meist kommen dafür Wagen der Typen Res, Rs und ähnliche Güterwagentypen zum Einsatz.

Mit etwa **205 x 29 mm** passt unser neues Ladegut auf die meisten H0-Modelle dieser Güterwagen. Unsere HEICO-Drahtrollen sind aus hochwertigem Resin gefertigt und alle einzeln handbemalt.



## HC6100

**Set di assi AC (4 pcs.), lunghezza dell'asse: 25,20 mm, diametro della ruota: 10,27mm, utilizzato in diversi carri con carrelli Y25 (Rivarossi, Jouef, Electrotren)**

Wechselstromradsätze (4 Stück), Achslänge: 25,20 mm, Raddurchmesser: 10,27 mm, passend z.B. für viele Güterwagen mit Y25-Drehgestellen (Rivarossi, Jouef, Electrotren)

Jeu de roues pour courant alternatif (4 pcs.), Longueur de l'essieu: 25,20 mm, diamètre de la roue: 10,27 mm, utilisé sur plusieurs wagons équipés de bogies Y25 (Rivarossi, Jouef, Electrotren)

Set de ejes AC (4 pcs.), longitud del eje: 25,20 mm, diametro de la rueda: 10,27mm, utilizado en varios vagones con bogies Y25 (Rivarossi, Jouef, Electrotren)

AC wheel sets (4 pcs.), axle length: 25,20 mm, wheel diameter: 10,27 mm, e.g. fits for many wagons with type Y25 bogies (Rivarossi, Jouef, Electrotren)



## HC6101

**Set di assi AC (2 pcs.), lunghezza dell'asse: 24,25 mm, diametro della ruota: 11,27mm, utilizzato in diversi carri a due assi (Rivarossi, Jouef, Electrotren)**

Wechselstromradsätze (2 Stück), Achslänge: 24,25 mm, Raddurchmesser: 11,27 mm, passend z.B. für viele 2-achsige Güterwagen (Rivarossi, Jouef, Electrotren)

Jeu de roues pour courant alternatif (2 pcs.), Longueur de l'essieu: 24,25 mm, diamètre de la roue: 11,27 mm, utilisé sur plusieurs wagons à 2 essieux (Rivarossi, Jouef, Electrotren)

Set de ejes AC (2 pcs.), longitud del eje: 24,25 mm, diametro de la rueda: 11,27mm, utilizado en varios vagones de dos ejes (Rivarossi, Jouef, Electrotren)

AC wheel sets (2 pcs.), axle length: 24,25 mm, wheel diameter: 11,27 mm, e.g. fits for many 2-axle wagons (Rivarossi, Jouef, Electrotren)



## HC6102

**Set di assi AC (4 pcs.), lunghezza dell'asse: 24,25 mm, diametro della ruota: 10,50mm, utilizzato in carrozze tipo UIC-X (Rivarossi, Electrotren) e treni Talgo III e Pendular (Electrotren)**

Wechselstromradsätze (4 Stück), Achslänge: 24,25 mm, Raddurchmesser: 10,50 mm, passend z.B. für Reisezugwagen des Typs UIC X (Rivarossi, Electrotren) sowie Talgo III und Talgo Pendular (Electrotren)

Jeu de roues pour courant alternatif (4 pcs.), Longueur de l'essieu: 24,25 mm, diamètre de la roue: 10,50 mm, utilisé sur plusieurs voitures type UIC-X (Rivarossi, Electrotren) et compositions Talgo III et Talgo Pendular (Electrotren)

Set de ejes AC (4 pcs.), longitud del eje: 24,25 mm, diametro de la rueda: 10,50mm, utilizado en coches tipo UIC-X (Rivarossi, Electrotren) así como en trenes Talgo III y Pendular (Electrotren)

AC wheel sets (4 pcs.), axle length: 24,25 mm, wheel diameter: 10,50 mm, e.g. fits for UIC X coaches (Rivarossi, Electrotren) as well as Talgo III and Talgo Pendular trains (Electrotren)



## HC6103

**Set di assi AC (3 pcs.), utilizzato in diversi carri con tre assi (Rivarossi, Jouef, Electrotren)**

Wechselstromradsätze, passend für alle unsere Autotransportwagen und Schiebeplanwagen mit drei Achsen (Rivarossi, Electrotren, Jouef)

Jeu de roues pour courant alternatif (3 pcs.), utilisable sur plusieurs wagons porte-automobiles et wagons à bache coulissant équipés de trois essieux (Jouef, Electrotren, Rivarossi)

Set de ejes AC (3 pcs.) para todos nuestros vagones porta-coches y vagones de plataforma con toldo corredizo de tres ejes (Electrotren, Jouef, Rivarossi)

AC wheel sets (3 pcs.), fits for all our car-transporter and tarpaulin wagons with three axles (Electrotren, Jouef, Rivarossi)



## HC6104

**Set di assi AC (4 pcs.), lunghezza dell'asse: 24,00 mm, diametro della ruota: 11,50mm, utilizzato in carrozze tedesche tipo B OSShD (Rivarossi)**

Wechselstromradsätze (4 Stück), Achslänge: 24,00 mm, Raddurchmesser: 11,50 mm, passend z.B. für Reisezugwagen der Bauart OSShD, Typ B (Rivarossi)

Jeu de roues pour courant alternatif (4 pcs.), Longueur de l'essieu: 24,00 mm, diamètre de la roue: 11,50 mm, utilisé sur voitures type B allemand (Rivarossi)

Set de ejes AC (4 pcs.), longitud del eje: 24,00 mm, diametro de la rueda: 11,50mm, utilizado en coches alemanes tipo B OSShD (Rivarossi)

AC wheel sets (4 pcs.), axle length: 24,00 mm, wheel diameter: 11,50 mm, e.g. fits for German OSShD, type B coaches (Rivarossi)



## HC6105

**Set di assi AC (4 pcs.), lunghezza dell'asse: 23,50 mm, diametro della ruota: 10,30 mm, utilizzato in diversi carrozze SNCF (Jouef)**

Wechselstromradsätze (4 Stück), Achslänge: 23,50 mm, Raddurchmesser: 10,30 mm, passend z.B. für verschiedenen SNCF-Reisezugwagen wie Mistral '69 oder Gran Confort (Jouef)

Jeu de roues pour courant alternatif (4 pcs.), Longueur de l'essieu: 23,50 mm, diamètre de la roue: 10,30 mm, utilisé sur les voitures SNCF Mistral '69 et Gran Confort (Jouef)

Set de ejes AC (4 pcs.), longitud del eje: 23,50 mm, diametro de la rueda: 10,30 mm, utilizado en varios coches SNCF de los tipos Mistral '69 y Gran Confort (Jouef)

AC wheel sets (4 pcs.), axle length: 23,50 mm, wheel diameter: 10,30 mm, e.g. fits for many SNCF coaches like the types Mistral '69 and Gran Confort (Jouef)



## HC8040

**Set di quattro ganci automatici tipo Scharfenberg funzionanti; innesto a norme NEM 362 e 363, con presganciamento automatico e regolabili in altezza. Nella realtà questi ganci sono usati principalmente per automotrici, elettromotrici, metropolitane e tram. Questo gancio può essere utilizzato su tutti i modelli con innesto compatibile.**

Vierteiliges Set Modellbahnkupplung nach System Scharfenberg, passend für alle Norm-Kupplungsaufnahmen nach NEM 362 und NEM 363, automatisch entkuppelbar, höhenverstellbar. Beim Vorbild werden Kupplungen dieses Typs hauptsächlich bei Triebwagen, Triebzügen, U-Bahnen und Straßenbahnen eingesetzt. Die Modellkupplungen sind universell verwendbar. Farbe: Schwarz.

Set de 4 attelages Scharfenberg. Attelages Scharfenberg fonctionnels pour boîtiers NEM 362 et 363, pré-dételage automatique, réglables en hauteur. Les attelages Scharfenberg sont utilisés en réalité sur de nombreux autorails, rames automotrices, TGV, tramways et métros. Cet attelage peut être utilisé sur tout modèle réduit équipé d'un boîtier NEM.

Set de 4 enganches tipo Scharfenberg, cumpliendo NEM 362 y 363, que puede ser desenganchado automáticamente y es ajustable en altura. En la realidad este tipo de enganches se usa en automotores, unidades múltiples, metro y tranvías. En modelismo este tipo de enganche se puede usar universalmente.



## HC8053

**Set di dieci ganci realistici universali in metallo**

10er-Set realistische Metall-Kupplungen  
Set de 10 attelages métalliques fonctionnels  
Set de 10 enganches de husillo metálicos  
Set of 10 realistic metallic couplers

Keine Funktionskupplung! Nur für dekorative Zwecke

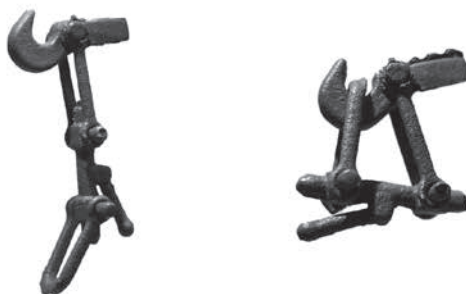

## HC8006

Filo di contatto della catenaria, lunghezza 270 mm  
Oberleitungs-Fahrdrabt, 270 mm  
Catenary wire, 270 mm  
10 units

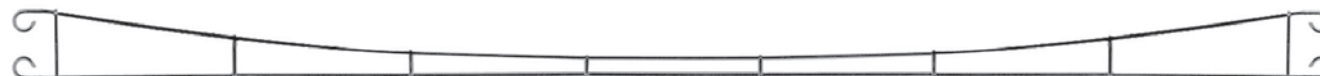

## HC8007

Filo di contatto della catenaria, lunghezza 360 mm  
Oberleitungs-Fahrdrabt, 360 mm  
Catenary wire, 360 mm  
10 units

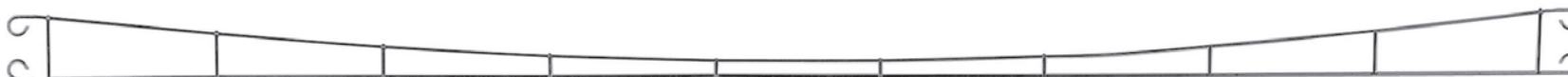

## HC8034

Palo per la catenaria  
Schnellbahn-Streckenmast  
High speed lines mast  
10 units



## HC8035

Palo per catenaria  
Streckenmast  
Catenary mast  
10 units







### HC8036

Palo per catenaria grigio  
Gitter-Streckenmast, grau  
Lattice mast, grey color  
10 units



### HC8037

Palo per catenaria, con cavo di allacciamento  
Anschlussmast mit Kabel  
Mast with electrical connection  
10 units



### HC8038

Palo per catenaria verde  
Gitter-Streckenmast, grün  
Lattice mast, green color  
10 units



### HC8039

Palo per catenaria, con cavo di allacciamento  
Anschlussmast mit Kabel  
Mast with electrical connection  
10 units



# TRACK, POWER & ACCESSORIES

The majority of this year's Hornby train sets include a smart and functional R7229 DC analogue controller, ideal for those starting out into the world of model railways, as not only does it offer smooth control both forward and reverse but also an uncontrolled auxiliary output for single point motor operation or indeed lighting.

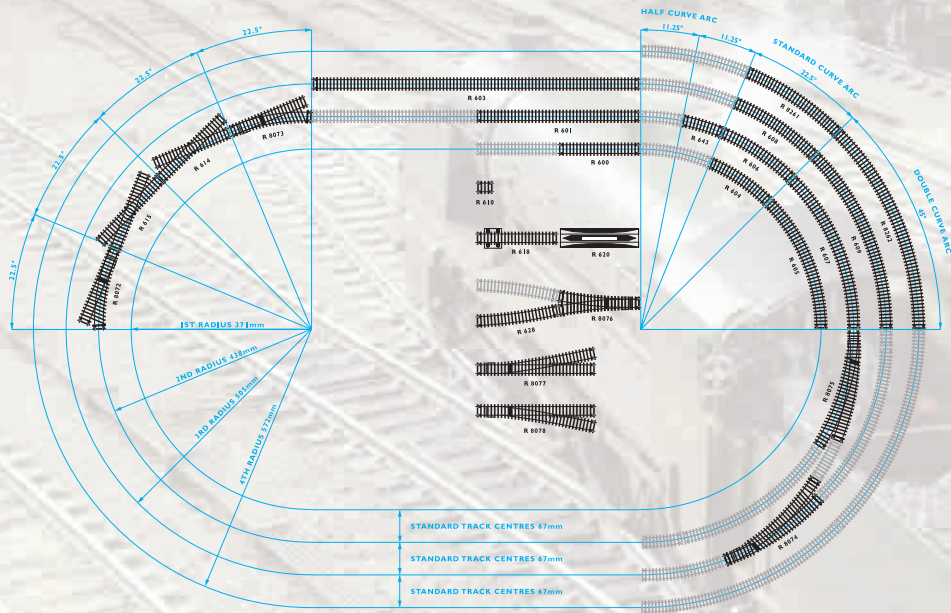

Excluding the Hornby Dublo 'Royal Scot' Set and the two Tri-ang Railways Remembered Sets the one set that does not include the R7229 controller is the exciting 'smartphone' or tablet operated iTraveller 6000, which features the revolutionary app based HM6000. This app allows for most 'smartphones' and tablets to control not only one circuit but initially two, with the option of adding a further three HM6000 units; eventually providing control of eight circuits in total. However, there is also one amazing part of the HM6000 and that is the Track Builder feature, which allows for schematic track designs to be created and once completed produces an itemised parts list.

For those interested in controlling the locomotives rather than the track, then Hornby DCC (Digital Command Control) would be the answer. DCC offers many advantages over regular DC Analogue Control. For example, independent control of locomotives that share the same track. Locomotives fitted with sound and steam add an extra dimension to a layout, and then there is the ease of wiring.

The benefits are both exciting and rewarding, however there is an extra cost compared to DC as each locomotive must be fitted with a decoder. No matter whether the choice is DC or DCC, Hornby will be there to help, guide and provide.

## Track Planning Symbols

**R619** Track Planning Symbols

Before you spend money on the real track - model your track layout ideas with these quarter scale track section replicas. Sections clip together to build your layout in miniature.

Pack contains more than 100 track pieces, representing most types of section that you may use.



## Straight Track

**R610** Quarter Straight

**R600** Straight Track

**R601** Double Straight

**R603** Long Straight

## Points & Flexible Track

**R614** Diamond Crossing - Left Hand

**R615** Diamond Crossing - Right Hand

**R8076** Y Point

**R8072** Left Hand Point

**R8073** Right Hand Point

**R8074** Left Hand Curved Point

**R8075** Right Hand Curved Point

**R8077** Left Hand Express Point

**R8078** Right Hand Express Point

**R618** Double Isolating Track

**R621** Flexible Track (970mm)

**R8090** Semi-Flexible Track (915mm)

## Curved Track

**R604** Curve - 1st Radius

**R605** Double Curve - 1st Radius

**R643** Half Curve - 2nd Radius

**R606** Curve - 2nd Radius

**R607** Double Curve - 2nd Radius

**R608** Curve - 3rd Radius

**R609** Double Curve - 3rd Radius

**R8261** Curve - 4th Radius

**R8262** Double Curve - 4th Radius

**R628** Half Curve (33") Large Radius

**R8087** Track Rubber

### Track Accessories

			
<b>R617</b> Uncoupling Ramp	<b>R620</b> Railer/Uncoupler	<b>R8244</b> Uncoupler Unit	<b>R910</b> Fishplates (x 12)
			
<b>R920</b> Insulated Fishplates (x 12)	<b>R207</b> Track Pins	<b>R626</b> Underlay Sheets (x 4)	<b>R638</b> Roll of Underlay

### Wheels & Coupling Hooks

			
<b>R8098</b> 12.6mm Spoked Wheels	<b>R8097</b> 12.6mm Disc Wheels - 3 hole (x 10)	<b>R8096</b> 12.6mm Disc Wheels (x 10)	<b>R8218</b> 14.1mm Disc Wheels (x 10)
			
<b>R8264</b> 14.1mm Disc Wheels - 2 hole (x 10)	<b>R8234</b> 14.1mm Disc Wheels - 4 hole (x 10)	<b>R8100</b> 12.6mm Split Spoked Wheels (x 10)	<b>R913</b> Con Rod Nut Spanner - Double Ended
			<b>NEW Q2</b>
<b>R8268</b> Large Width Couplings (x 10)	<b>R8267</b> Medium Width Couplings (x 10)	<b>R8099</b> Coupling Assemblies (x 10)	<b>R7398</b> Buckeye Magnetic Coupling - 8 Pairs
			<b>NEW Q2</b>
<b>R8220</b> Pocket Coupling (x 10)	<b>R8219</b> NEM Couplings (x 10)	<b>R7200</b> Small Coupling Assembly (x 4)	<b>R7399</b> Vacuum Pipe Magnetic Coupling 11mm - 8 Pairs
			<b>NEW Q2</b>
			<b>R7400</b> Vacuum Pipe Magnetic Coupling 10mm - 8 Pairs

### Rolling Road

Locomotive not included



Spare Rollers available in packs of two as R8212

**R8211** Rolling Road

	<b>R8012</b> HM 2000 Analogue Controller
A complete transformer with built-in control for two separate trains. Power output is 2 Amps, with compensation to regularise speed under varying conditions of load. Positive 'off' rotary speed control cuts all power when the control knob is turned to zero. Features include forward and reverse switch, plus LED indicators for mains supply and output power. Outputs include non-variable AC and DC power for point motors and other powered accessories.	
	<b>P9001</b> Standard Wall Plug Mains Transformer
Replacement transformer for R8250 Standard Train Controller.	
	<b>R7229</b> Analogue Train and Accessory Controller
Note: Do not connect directly to the mains electricity supply. For use with P9000 Mains Transformer ONLY	
	<b>220-240V 50-60Hz Transformer</b> , supplying 16V AC current to R8250 and R7229 Analogue Train Controllers. Comes fitted with a 3m output lead.
	<b>R8206</b> Power Track
	<b>R602</b> Power Connecting Clip
	<b>R8201</b> Track Link Wire Pack
	<b>R8015</b> Point Motor Housing (Adaptor Base)
	<b>R044</b> Point Motor Passing Contact Switch - Black
	<b>R046</b> Two Way Lever Switch On/On - Yellow
	<b>R047</b> Two Way Lever Switch On/Off - Green
	<b>R8014</b> Point Motor
	<b>R8243</b> Surface Mounted Point Motor
	<b>R171</b> Single Home Signal
	<b>R406</b> Coloured Light Signal (Remote Control)
	<b>R172</b> Single Distant Signal
	<b>R169</b> Junction Home Signal
	<b>R170</b> Junction Distant Signal

Analogue Control & Accessories





**R8213** 'Select' Digital Controller

Note: This controller can only access Functions F0 to F8

The Select is capable of controlling up to 59 locomotives and - providing power is available - of running up to 10 locomotives at once.

The Select can also operate 38 solenoid operated accessories, including points.

- Commands up to 10 locomotives simultaneously (providing power is available).
- The possibility of up to 3 locomotives running at any one time using the 1 amp transformer supplied.
- A 4 amp transformer is available for added power, allowing command of up to 10 locomotives simultaneously.
- Incorporates 128 speed steps for smooth locomotive control. Can be programmed to accommodate 14 and 28 speed steps.
- Able to programme 59 locomotives and 38 accessories. (The 60th locomotive would be coded as '0' and does not require a decoder).
- Supports XpressNet protocol.
- The 'Select' can also be used as a 'Walkabout' unit when connected to another Hornby 'Select' or the Hornby 'Elite' unit.
- Up to 29 locomotive functions. Can switch on and off locomotive lights and sounds including whistles, horns, etc. when used with locomotives fitted with sound decoders.



**R8214** 'Elite' Digital Controller

The Elite has twin, press switch controls, 17 button keyboard, wide LCD screen display, a 4 amp transformer and is capable of registering 254 locomotive addresses, as well as 255 accessory addresses, including point control.

- The 'Elite' can programme in all 4 modes: Direct, Register, Paged and Operate.
- 3 speed steps - 14, 28, 128.
- NMRA Certified. Complies with EMC requirements.
- Supports Short and Extended Addressing.
- Allows 64 consists (Double Heading).
- Controls up to 64 locomotives at any one time providing the power is available.
- The facility to operate up to 29 functions.
- Single button press for fast selection of last 10 locomotive or accessory addresses under control.
- USB for downloading system updates and for connection to third party software.
- Separate Programming and Mainline Connections.
- Locomotive search function.
- A Programmable 'scale' clock. Ratios from 1:1 (real time) up to 1:10.



**R8247** Digital Accessory & Point Decoder



**R7274** 4 pin Decoder



**R7150** Standard 6 pin Decoder



**R8249** Standard 8 pin Decoder

**Also available...**

**NEW Q!** **R7401** 18 Pin Decoder - No Sound

**NEW Q!** **R7402** 21 Pin Decoder - No Sound

**R7382** 21 Pin Decoder

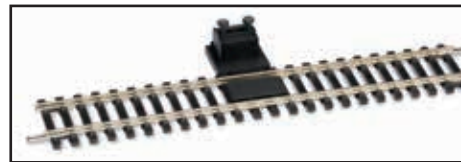

**R8241**

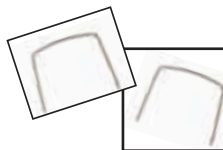

**R8232**



**R8242**

**MAGLIGHT**



In many instances a coach fitted with lights has to rely mainly on collecting power from the track via a copper pick up strip pressing against at least one of the coach's axles or wheels. By its very nature such friction on the axle creates drag and therefore reduces the number of coaches that can be pulled behind a locomotive. For rakes of coaches being pulled by a large locomotive, for example a Pacific, this may not prove to be an issue but for a full rake of the new Mk3 coaches being pulled by a Class 43 (HST) unit such drag may affect the overall scale speed of the train but certainly not if the coaches are fitted with Hornby's Maglight system.

The Maglight system is a creative and unique development by Hornby that provides lighting in coaches with the minimum of fuss with no excessive drag because power is provided on board the coach and not by a tension pick up on the axle or wheel.

The Maglight system consists of an LCD strip, small button battery and a reed switch. Once installed the lights are switched 'on' and 'off' by just passing a 'magnet wand' over the coach roof. The small easily replaced button battery provides in excess of 200 hours of power making the Maglight system a simple but effective way of lighting coaches but with the minimum of fuss.

This unique to Hornby system is ideal for those who wish to retro fit Maglights to the majority of Hornby coaches but in particular the 4 and 6 wheel coaches, as well as the new Mk3 coaches, the installation of which is

both simple and very effective. Maglights also allow the modeller to be selective as to which coach lights are 'on' or 'off' a feature that negates the need to install expensive decoders.

**Fit the MagLight system in 6 easy steps...**

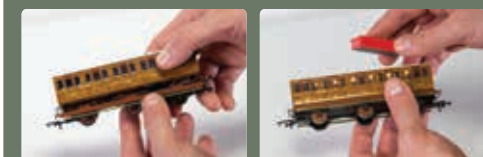

**NEW Q!** **R7305** Maglight for Mk3 Coaches

**R7338** Maglight Lighting Unit for 4/6 Wheel Coaches



HM  
DC

HORNBY

# Railway App Control

## Features include...

- Features locomotive sounds including horns, whistles, steam sounds and many more
- Individual Acceleration and Deceleration controls per circuit
- Works with all major IOS or Android smart phones and tablets
- Operates locomotive, points and accessories
- Controls up to 8 separate circuits
- Intuitive layout design feature

## The 21st Century control system for today's 12V DC model railway.

R7293



R7292



# HM | DC

Control literally at your fingertips.

### R7293 HM6010 App Based Analogue Control

The HM6010 and the HM | DC App Control brings a wealth of new features and functions to enjoy: control point motors, signal lighting, street lighting, motor-driven accessories, turntables and conveyor belts with ease. Paired with the new HM | DC app: control up to 4 accessories (sold separately) per HM6010, control up to 12 accessories per phone or tablet with more HM6010 units (max of 3 total). Please note: Each HM6010 unit requires a transformer (sold separately), and a compatible phone or tablet is required.

### R7292 HM6000 App Based Analogue Control

The HM6000 and the HM | DC App Control brings brilliant new features and functions to use: control speed, direction, acceleration, deceleration, minimum & maximum speeds, 18 in-app locomotive sounds, an emergency stop and short-circuit detection.

Also, build your dream layout with the Track Builder included with the free HM | DC app. The HM6000 is connected to the circuit using a R8206 Power Track or R602 Power Connecting Clip.

Please note: Each HM6000 unit requires a transformer (sold separately) and a compatible phone or tablet is required.

### HT8300 R600 Straight Track x 4

### HT8301 R606 2nd Radius Curve x 4

### HT8302 R8072 Left Hand Point x 1

### HT8304 R8073 Right Hand Point x 1

### P9100 UK Hornby Digital Transformer 15V 1A

## Introducing the App based analogue control – HM6000

Technology has moved on when it comes to controlling a analogue DC layout. From now on there is no need for the controller to be tethered to the track because by using Bluetooth low energy (BLE) technology Hornby's HM6000 control system can operate a DC layout with consummate ease. The HM6000 system not only provides simple control of two circuits but also features inertia and braking control, loco sounds, minimum and maximum speed control plus an intuitive layout planning feature.

Utilising both Bluetooth Low Energy (BLE) and Bluetooth Mesh Network architecture, developed by Hornby, the HM6000 provides a stable and responsive system that becomes increasingly efficient the more a model layout develops.

## Locomotive Control

The HM6000 DC application is simple and straightforward to use and includes many features not included in other DC controllers, for example the HM6000 not only controls a locomotives speed and direction but also the braking of the model which can be incrementally applied.

By 'calling up' the Track Settings screen on the chosen smart 'phone or tablet, additional control of a locomotive can be achieved by setting the maximum and minimum speed levels of the chosen circuit.

## Sounds

One of the key features of the HM6000 DC system is the inclusion of steam, diesel and electric locomotive sound profiles. Each profile has six railway based sounds allocated. For example the Steam allocation includes whistle, wheel slip, coal shovelling, braking and a Guards whistle, while the diesel features engine start up and shut down, two horns high - low and low - high,

## Accessory Control

The HM6010 DC operating accessory unit provides multiple ways of controlling accessories including those that require a constant current or others that function from receiving a short burst of power. HM6010 allows the user to flick between Red, Green or Off for signal lights, On or Off for street or model house lighting plus providing constant power for accessories such as turntables.

## Track Builder

Integrated into the HM|DC application is a very useful function that provides the facility to plan and build numerous layouts while at the same time listing the components required as the virtual layout takes shape.

Add, remove, snap, rotate and duplicate track pieces or sections to form large and compact layouts.

## Settings

The HM6000 DC App. Has a selection of different functions or toggles that will allow for the fine tuning of each circuit.

The App. is programmed to include several languages for true international usage.

## Short Circuit Detection

An innovative and rapid short circuit detection system included in the HM6000 software can quickly detect a short circuit and providing that the short has been removed, the system can once again become 'live' with a touch of a virtual button.

## Device Provisioning

Both the HM6000 control and HM6010 accessory units can easily be paired with the HM | DC application through the chosen device provisioning settings, which can be found within the application.

## Transformers required

For customers ordering from Europe, Australia, USA or Canada please be advised that the required transformers for each country are:

UK: P9100

Europe: P9101

Australia: P9102

The App based HM|DC system is built around two pieces of hardware which form the key elements of the set up and these are the HM6000 App Circuit Controller and the HM6010 App Operating Accessory unit.

The HM6000 is paired with the HM|DC application on a smartphone or tablet and provides control of up to 2 circuits independent of each other. Up to 4 HM6000 units can be linked to the application which consequently provides control of 8 independent circuits via one device be it a smart 'phone or tablet.

Similarly the HM6010 is also paired with the HM | DC application on a smartphone or tablet and that in turn allows for the control of up to 4 accessories be they continuous current such as used for lighting or a quick burst of power used to operate a point motor. Up to three HM6010 units can be linked to the application providing control of up to twelve accessories from one smart 'phone or tablet.

With this feature the minimum and maximum speed range setting can allow for fine tuning of a locomotive's speed by increasing the minimum start speed and in turn limiting the maximum speed.

An "Emergency Stop & Resume" function are also featured to immediately halt all circuits at the touch of a virtual button, this allowing for an effective pause time to alter settings before resuming with new settings in place.

brake squeal, flange squeal and wagons buffering. For the electric locomotive profile the sounds include start up, horn, brake, brake release, flange squeal and the Guard to Driver bell.

All these sounds are emitted from the smartphone or tablet and adds real train atmosphere to the layout.

Points and certain other accessories require a quick pulse of current and this too can be provided by the HM6010 App. These operations can be activated via the dedicated accessories screen on a smart 'phone or tablet or through using the accessory toolbar that is integrated into the circuit control screen.

Once finished, the track layout can be exported as a bill of materials to assist in building the planned layout.

The track pieces are scaled and are virtually laid on a user applied dimensioned baseboard to ensure the layout will fit.

Slider (throttle) behaviour can be set to a "drop & action" method or to "live finger swiping", which typical physical controllers would traditionally use. "App Inactivity Control" can be altered to ensure that no interruptions to your locomotives running are made by your device.

Such a function can prove to be very useful should a locomotive move from one circuit to another which may be operating with opposite polarities. Such an action will cause a short circuit which can quickly and easily be corrected by altering a directional button on the circuit control screen.

## Scan Me...



...to download the **FREE**  
HMDC App Today!







# HM7000 HM | DCC

**Features include...**

- Control via FREE to download HM|DCC Bluetooth® app using a smart 'phone or tablet
- Bluetooth® technology enabling fast and wire-free Programming and Control
- Choice of Bluetooth® decoders with and without sound facility
- Bluetooth sound decoders include sugar cube speakers and variable sized sound boxes
- FREE downloadable Triplex sound profiles unique to Hornby
- Up to 25 Sounds per download
- Currently 35 plus sound files available
- All decoders offer plug-in Power Bank facility
- Hornby Bluetooth decoders are fully compatible with existing Hornby DCC controllers
- Power Bank offers up to 9 seconds of backup power
- CV editing on the layout. No need for Programming Track

## Introducing Hornby HM7000 HM|DCC

Although DCC offers many advantages over conventional DC control there are still several disadvantages. With the currently available DCC systems good and consistent control relies on the command signals being passed down the track to the chosen locomotives. Any break in the command signals reaching the chosen locomotive due to poor track connections or possibly dirt on the track can result in the model stalling. This can be quite frustrating especially if the locomotive has to go through a start up sequence before moving off once more.

Changing a locomotive's CV (Configuration Variables) settings can also become a challenge as normally models have to be lifted from the track and placed on a Programming Track before CVs can be changed. Changing a locomotive's CV settings while still on the layout can result, annoyingly with all locomotives being affected by the change, however Hornby are once again on the cutting edge of innovation and operating a model railway has entered a new age of control.

The HM7000 model railway control series offers many advantages over the existing old style DCC units. Firstly, it uses an app based Bluetooth® protocol and can be downloaded on to the majority of available smart 'phones and tablets, which in turn can then be used to control a model railway. No more expensive Command Base units as the HM7000 app is totally free, just scan the HM7000 QR code and follow the instructions. It is that simple.

Secondly, there are 3 available sound decoders - 21 pin, Next 18 pin and 8 pin decoders. Each decoder is Bluetooth® enabled and is supplied complete with detachable sugar cube speaker and multi sized sound box to provide maximum depth of sound, given the available space. Initially, there are in excess of 30 free downloadable sound files to suit the more popular steam, diesel and electric locomotives with each file having in excess of 20 individual sounds.

For those who prefer to run silently, there are 4 non sound Bluetooth® decoders - 21 pin, Next 18 pin, 8 pin and 6 pin. Each of the Bluetooth® decoders, be they sound or non-sound incorporate a mini socket that allows for the fitting of an HM7070 Power Bank module. The Power Bank provides up to 9 seconds of backup power should the locomotive encounter a power outage due to dirty or poor track work.

The versatility of the new Hornby HM7000 Bluetooth® enabled control system is superbly highlighted with the numerous and low cost ways that any existing layout, either DC or DCC can be controlled using the power of the HM7000 system while wholeheartedly embracing Bluetooth® technology.

### Get started with HM7000 in just four simple steps!

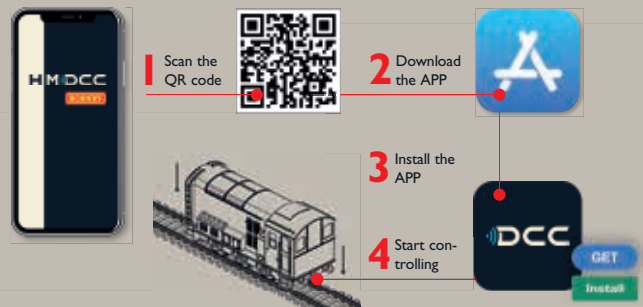

## Setting up a new or converting an existing DCC system to HM7000

### Train Set control - HM7000 HM|DCC

For many who enter the world of model railways they tend to start with a train set but invariably as interest grows their thoughts inevitably turn to DCC but are soon dampened by the potential cost. Not so with the HM7000 HM|DCC system. All that needs to happen to go digital is the installation of a Bluetooth® enabled Hornby non-sound decoder into a chosen locomotive. The HM7000 app can then be downloaded onto a smart device and paired with the loco. Next, the model is placed onto the track and the DC controller is moved up to full voltage. Once this is done the model can be operated via the smart device. Full DCC operation for the price of a Bluetooth decoder. No other system can offer DCC control at such an economic level.

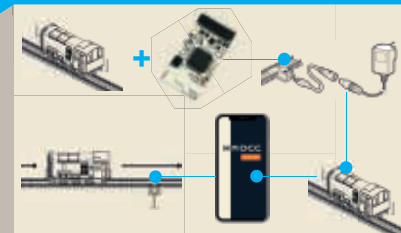

### HM6000 HM|DC - HM7000 HM|DCC

The HM6000 system uses the Bluetooth® protocol and therefore any layout using this system is only a short step away from being HM7000 HM|DCC compliant.

To convert an HM6000 layout to HM7000 control there are just six simple steps that need to be taken:

- Step 1:** Download the HM|DCC app. Onto a suitable smart 'phone or tablet.
- Step 2:** Choose a locomotive to operate on DCC and instal the appropriate decoder.
- Step 3:** Link the locomotive to the smart device which has the HM|DC app already installed.
- Step 4:** Fit DCC clips to all points and remove all non DCC fitted locomotives from the layout.
- Step 5:** Using the HM|DC app, slide acceleration control should be moved to full power.
- Step 6:** Switch to the HM|DCC app and the HM7000 fitted locomotive can now be operated.



### HM7000 HM|DCC

For those who are just starting in modelling railways and wish to control their layout using the HM7000 HM|DCC control system, installation and operation could not be simpler

As with other connections, the HM7000 app will need to be downloaded on to a preferred smart device. The chosen locomotive or locomotives will each require the fitting of a suitable Hornby Bluetooth® enabled decoder. Power to the track can be via a suitable Hornby 1A, 1.2A or 4A transformer. To link the transformer to the Hornby Power Track it is necessary to connect in line between the transformer and the track an HM7020 Power Supply Adapter Harness. Once power is connected it is then possible to link the Hornby Bluetooth® enabled locomotives to the smart device and operations can begin.



### DCC Upgrade using Hornby HM7000 HM|DCC control

For those who are already operating their layout using DCC it is possible to have the benefits of operating some of their trains with the Bluetooth® protocol using the HM|DCC app. To do this it is required for the HM|DCC app to be downloaded to a selected smart device, either 'phone or tablet. Next, locomotives must be fitted with a suitable Hornby Bluetooth® enabled decoder and paired with the smart device. Once this process is completed those models can now be controlled using the smart device. All other locomotives can be controlled using the existing DCC unit only. Similarly, it is possible for all locomotives fitted with either a Hornby HM7000 or conventional decoder to be operated using the HM|DCC Bluetooth® system via a smart device. To do this an HM7040 Legacy Dongle must be plugged into the RJ 12 socket of an existing DCC Base Station, such as can be found on the Hornby 'Elite' or 'Select'.

Having connected the Legacy Dongle ALL locomotives can be controlled by either the smart device or the Base Station, however only those fitted with an HM7000 type decoder can have the CV settings changed while on the layout. All other models must have their CVs changed in the conventional way.

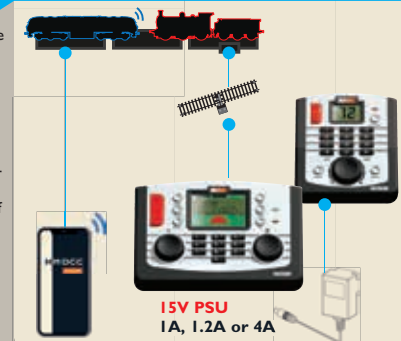

Sky's the limit...Hornby HM7000





# HM DCC 7000

Hornby Bluetooth decoders are fully compatible with existing Hornby DCC controllers



**NEW Q2 R7377** HM - Power Bank Pack



**R7326** HM7040 Legacy Dongle for existing DCC Controllers



**NEW Q2 R7324** HM7020 PSU Solution (Harness)



**NEW Q2 R7336** HM7000 8TXS BLE Decoder (8 Pin - TXS Sound)



**NEW Q2 R7321** HM7000 6 BLE Decoder (6 Pin - No Sound)



**R7335** HM7000 8 BLE Decoder (8 Pin - No Sound)



**NEW Q2 R7322** HM7000 21TXS - BLE Decoder (21 Pin - TXS Sound)



**NEW Q2 R7345** HM7000 NI8TXS BLE Decoder (Next18 Pin - TXS Sound)

Also available...

**NEW Q4 R7327** HM7050 Reverse Loop Module

**NEW Q2 R7337** HM7020 PSU Solution (Harness) & Digital 15V 4 Amp Transformer



**NEW Q2**

## HM7000 Sound Downloads

<b>SD001</b> Sound Download - A3	<b>SD019</b> Sound Download - Britannia
<b>SD002</b> Sound Download - A4	<b>SD020</b> Sound Download - Merchant Navy
<b>SD003</b>	<b>SD021</b>
<b>SD004</b> Sound Download - Class 43 MTU	<b>SD022</b> Sound Download - Class 50
<b>SD005</b> Sound Download - Class 91	<b>SD023</b>
<b>SD006</b> Sound Download - Class 73	<b>SD024</b> Sound Download - B12
<b>SD007</b> Sound Download - Class 800	<b>SD025</b> Sound Download - W1
<b>SD008</b> Sound Download - P2	<b>SD026</b> Sound Download - 9F
<b>SD009</b> Sound Download - Class 08	<b>SD027</b> Sound Download - 4 VEP
<b>SD010</b> Sound Download - Tornado	<b>SD028</b> Sound Download - Class 87
<b>SD011</b>	<b>SD029</b> Sound Download - Black 5
<b>SD012</b> Sound Download - Class 40	<b>SD030</b> Sound Download - Class 755 Flirt
<b>SD013</b> Sound Download - Class 37	<b>SD031</b> Sound Download - Turbomotive
<b>SD014</b> Sound Download - Class 71	<b>SD032</b> Sound Download - Class 55 Deltic
<b>SD015</b> Sound Download - Class 67	<b>SD033</b> Sound Download - A1/A3, Sound Generator Fitted
<b>SD016</b> Sound Download - Class 2P	<b>SD034</b> Sound Download - P2, Sound Generator Fitted
<b>SD017</b> Sound Download - Class 4F	<b>SD035</b> Sound Download - Black 5, Sound Generator Fitted
<b>SD018</b> Sound Download - Class 31	

# Track & Building Extension Packs

The set track layout as shown on the **MidiMats** provided in most train sets can be extended in easy steps by adding **Track Packs**, all the way up to the full layout and beyond.

**R8217** TrakMat 1800mm x 1200mm



**R8227** Building Extension Pack 1

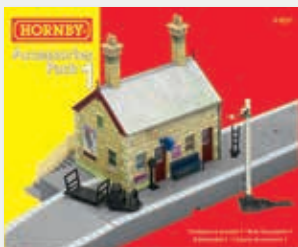

**R8228** Building Extension Pack 2



**R8229** Building Extension Pack 3

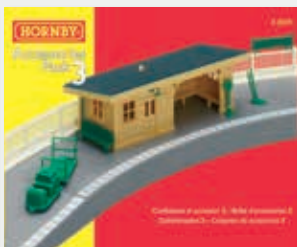

**R8230** Building Extension Pack 4



**R8231** Building Extension Pack 5



**R574** Trackside Accessories



**R8221** Extension Pack A



**Extension Pack A**  
Add Extension Pack A to the Starter Oval supplied with the smaller Hornby train sets to make this layout.

**R8222** Extension Pack B



**Extension Pack B**  
Add B to the Starter Oval + A to make this layout.

**R8223** Extension Pack C

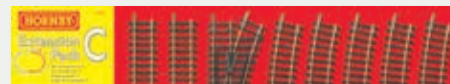

**Extension Pack C**  
Add C to the Starter Oval + A + B to make this layout.

**R8224** Extension Pack D



**Extension Pack D**  
Add D to the Starter Oval + A + B + C to make this layout. This would complete the layout on the MidiMat included in our Sets.

**R8225** Extension Pack E



**Extension Pack E**  
Add E to the Starter Oval + A + B + C + D to make this layout.

**R8226** Extension Pack F

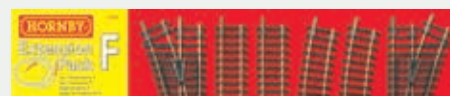

**Extension Pack F**  
Add F to the Starter Oval + A + B + C + D + E to achieve the full TrakMat layout. Complete the scene with TrakMat Accessory Building Packs and Hornby landscaping details.

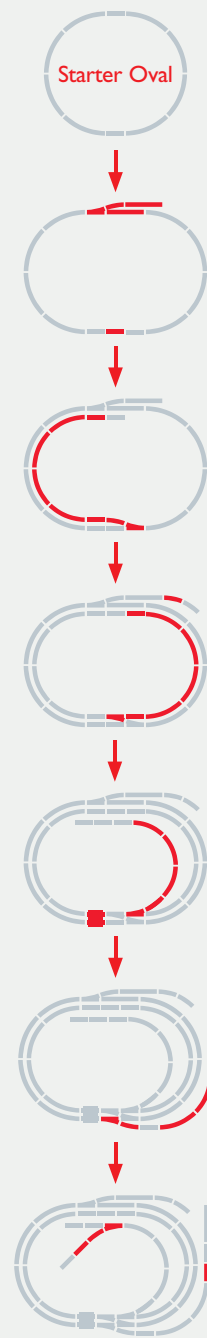



# A MODEL WORLD

## Buildings & Accessories

One of the most exciting parts of model railways is the planning of the layout. Will it be a country setting with rich green pastures and tree lined roads with a small village nestled around the train station, or an industrial layout with marshalling yards including a town with busy roads and an abundance of houses and shops.

Maybe it is planned for the layout to be a mixture of both with a wooded area off to one side while on another part of the layout a busy High Street with all the hustle and bustle associated with such an area. Whatever is decided much depends on the size of the layout, the demands of the modeller and their expectations.

Hornby offers a truly expansive range of buildings and scenic material that can add character and form to most layouts. For ease of construction the Hornby range of clip together buildings can be quickly and easily assembled and placed in situ in a very short space of time. Several stations from Wayside Halt to a major Station are available as are a Signal Box, Water Tower, Engine Shed and even a two lane Engine Shed, all of which are easily assembled.

For those who are looking for something a little more original than the hand painted ready made range of Skaledale resin buildings answers most needs from Stations to Shops and from houses to even a Church. Each structure is superbly hand crafted and quite frequently based on actual buildings.

For the truly admiring scenic effects of trees, hedges and ground cover (scatter) then the extensive selection from the SkaleScenic range will add surely be the answer.



**R8009** Station Terminus



**R590** Station Halt



**R513** Platform Fencing



**R8000** Country Station



**R083** Buffer Stop



**R394** Hydraulic Buffer Stop



**R8007** Booking Hall



**R8001** Waiting Room



**R076** Footbridge



**R510** Platform Shelter

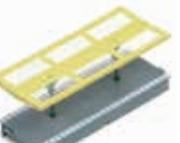

**R514** Platform Canopies (Pack of 2)



**R334** Station Over-Roof  
Platforms not included



**R464** Platform Ramp



**R463** Curved Platform (Small Radius)



**R460** Straight Platform

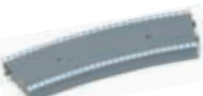

**R462** Curved Platform (Large Radius)



**R8005** Signal Box



**R8003** Water Tower



**R8004** Engine Shed



**R8002** Goods Shed

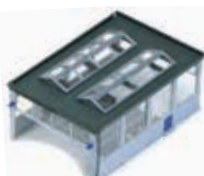

**R8006** Diesel Maintenance Depot



**R530** Pylons



**R645** Level Crossing, Single Track

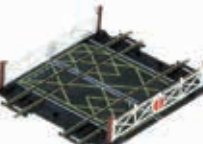

**R636** Level Crossing, Double Track



**R658** Inclined Piers



**R659** High Level Piers



**R909** Elevated Track Support Set



**R660** Elevated Track Sidewalls



**R537** Lineside Fencing



**R070** Motorised Turntable



**R189** Brick Bridge Length 111mm



**R180** Viaduct Length 332mm



**R8008** Grand Suspension Bridge Length 1372mm

**Elevated Track Running Length:** The maximum track running length to a height of 80mm with supports at 24 sleeper intervals is approximately 1344mm. However for a more gradual incline with the supports at 30 sleeper intervals the overall running length increases to approximately 1680mm.



# A MODEL WORLD

## Buildings & Accessories

### Model features include:

- 1:76 Scale
- Highly defined resin structures
- Detail features with hand finished embellishments
- Etched metal window frames (where appropriate)

### Tunnel Portals



**R8509** Single Stone Tunnel Portal x 2

**R8511** Double Stone Tunnel Portal x 2



**R8544** Stone Portal Side Walling

**R8545** Brick Portal Side Walling



**R8510** Single Brick Tunnel Portal x 2

**R8512** Double Brick Tunnel Portal x 2

### Brick & Stone Walling

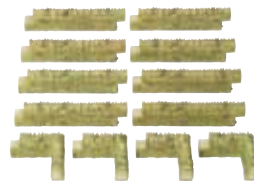

**R8526** Granite Wall Pack No. 1



**R8527** Granite Wall Pack No. 2

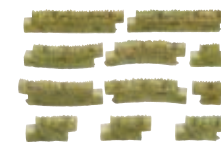

**R8538** Granite Wall Pack No. 3

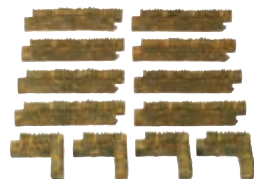

**R8539** Cotswold Stone Pack No. 1



**R8540** Cotswold Stone Pack No. 2



**R8541** Cotswold Stone Pack No. 3



**R8977** Brick Walling - Straight



**R8978** Brick Walling - Corners



**R8979** Brick Walling - Gates & Piers

### People & Animals

Note: These images are for illustration only, colours may differ from those illustrated.



**R7115** City People Pack of seven different people (male & female)

**R7116** Town People Pack of eight different people (male & female, adults & children)



**R7117** Working People Pack of six different people and three work items (male)

**R7119** Sitting People Pack of six different people and two benches (male & female)



**R7118** Farm People Pack of six different people (male & female)



**R7120** Farm Animals Pack of seven different animals and four sections of fencing



**R7121** Cows Pack of ten cows (two breeds)



**R7122** Sheep Pack of ten sheep

HORNBY

SKALEDALE

## Platforms & Accessories

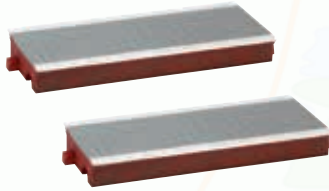

**R8614** Straight Platforms x 2

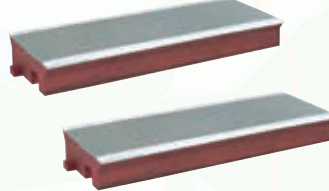

**R7304** Platform Island x 2

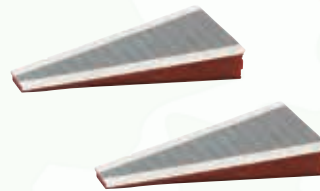

**R8615** Platform Ramps x 2



**R7285** Platform Straight x 2



**R7287** Platform Island x 2



**R7286** Platform Ramp x 2

**NEW Q4 R7371** Platform Steps



**NEW Q4 R7370** Platform End Ramp x 2

**R8674** Bench x 2



**R8673** Platform Lamps x 4

## Retaining Walls & Arched Viaducts



**R7373** High Level Arched Retaining Walls x 2 (Engineers Blue Brick)



**R7375** High Stepped Arched Retaining Walls x 2 (Engineers Blue Brick)



**R7368** Three Arch Viaduct with Lockups x 2 (Engineers Blue Brick)



**R7387** Mid Stepped Arched Retaining Walls x 2 (Engineers Blue Brick)



**R7389** Low Level Arched Retaining Walls x 2 (Engineers Blue Brick)



**R7385** Mid Level Arched Retaining Walls x 2 (Engineers Blue Brick)

### Engineers Blue Brick



**R7367** Three Arch Viaduct with Lockups x 2 (Red Brick)



**R7374** High Stepped Arched Retaining Walls x 2 (Red Brick)



**R7372** High Level Arched Retaining Walls x 2 (Red Brick)



**R7386** Mid Stepped Arched Retaining Walls x 2 (Red Brick)



**R7384** Mid Level Arched Retaining Walls x 2 (Red Brick)



**R7388** Low Level Arched Retaining Walls x 2 (Red Brick)

**NEW Q3 R7390** Girder Bridge

### Red Brick





# SKALE SCENICS

H0 & 00 Gauge Model Railway Scenics

**SkaleScenics are perfect for the miniature natural world!**

Without a model railway layout being situated in a natural environment then it is simply just small trains running on a track, however the moment trees, bushes and ground cover are added then the whole layout transforms and comes to life as a miniature world.

SkaleScenics provides a whole host of high quality model scenic fawner and flora that can be added to a layout as it is being built or if desired later, the decision is entirely up to the modeller.

The SkaleScenics range consists of an extensive selection of high quality trees, foliage, ground cover (scatter) and ballast. SkaleRoc is the perfect material to create hills, cuttings and even tunnels. In short with everything available in the SkaleScenic selection it will be found that there are many different ways to create an ideal environment, be it lush rolling hills, 'ancient' hedgerows, wooded enclaves, urban parks or just simple suburban gardens.

SkaleScenics, fawner at your fingertips.

## Classic Trees

Handmade for finer quality, the SkaleScenics Profi Tree range will bring added scenic detail to any model railway or diorama.

The trunks of the trees are painted by hand so that no shining plastic surfaces are left visible and to give more volume. All of the branches are covered with fine wool before they are flocced. This mimics the leaf shapes and colours of a real tree and, as in nature, only the fine branches of the PROFI trees have leaves, so this is replicated in our range.



<b>R7202</b>	Fruit Trees
80mm   Three per pack	



<b>R7203</b>	Maple Trees
90mm   Three per pack	



<b>R7204</b>	Beech Trees
130mm   Two per pack	



<b>R7205</b>	Birch Trees
45mm   Three per pack	



<b>R7206</b>	Large Fir Trees
80-120mm   Four per pack	



<b>R7207</b>	Small Fir Trees
40-80mm   Four per pack	



<b>R7208</b>	Bushes
30-40mm   Five per pack	



<b>R7209</b>	Oak Tree
150mm   Single item	



<b>R7210</b>	Lime Tree
185mm   Single item	



<b>R7211</b>	Horse Chestnut Tree
190mm   Single item	



## Hobby Trees

<b>R7198</b>	'Hobby' Deciduous Trees
50-90mm   Twenty per pack	



<b>R7201</b>	'Hobby' Mixed Trees
50-140mm   Twenty per pack	



<b>R7199</b>	'Hobby' Fir Trees
50-140mm   Twenty per pack	



## Professional Trees

<b>R7212</b>	Fruit Tree
75mm   Single item	



<b>R7213</b>	Apple Tree (with Fruit)
75mm   Single item	



<b>R7214</b>	Pear Tree
75mm   Single item	



<b>R7215</b>	Birch Tree
115mm   Single item	



<b>R7216</b>	Rowan Tree (with Berries)
115mm   Single item	



<b>R7217</b>	Acacia Tree
150mm   Single item	



<b>R7218</b>	Tree (with Circular Bench)
115mm   Single item	



<b>R7219</b>	Beech Tree
130mm   Single item	



<b>R7220</b>	Oak Tree
160mm   Single item	



<b>R7221</b>	Lime Tree
185mm   Single item	



<b>R7222</b>	Horse-Chestnut Tree
195mm   Single item	



<b>R7223</b>	Lime Tree
185mm   Single item	



<b>R7224</b>	Tree (with Tree House)
150mm   Single item	



<b>R7225</b>	Medium Nordic Fir Tree
120mm   Single item	



<b>R7226</b>	Large Nordic Fir Tree
145mm   Single item	



<b>R7227</b>	Medium Pine Tree
120mm   Single item	



<b>R7228</b>	Large Pine Tree
150mm   Single item	





**Ballast**

<b>R7164</b>	Brown	<b>R7165</b>	Grey	<b>R7166</b>	Limestone
Weight 250g		Weight 250g		Weight 250g	
<b>R7167</b>	Granite	<b>R7168</b>	Basaltic Rock	<b>R7169</b>	Gneiss
Weight 250g		Weight 250g		Weight 250g	
<b>R7170</b>	Coal				
Weight 250g					

100 Gauge Model Railway Scenics

**Scatter**

<b>R7171</b>	Flower Meadow	<b>R7172</b>	Light Green
Weight 42g		Weight 42g	
<b>R7173</b>	Medium Green	<b>R7174</b>	Brown
Weight 42g		Weight 42g	
<b>R7175</b>	Grey	<b>R7176</b>	Dark Green
Weight 42g		Weight 42g	

**Note:**  
To cover an area of 1m<sup>2</sup> you will need approximately 100 g scatter material and 500g of Grass Glue.

**Flockage & Flock**

<b>R7156</b>	Bright Green Flockage	<b>R7157</b>	Medium Green Flockage	<b>R7158</b>	Dark Green Flockage
Weight 20g		Weight 20g		Weight 20g	
<b>R7159</b>	Medium Brown Flockage	<b>R7160</b>	Dark Brown Flockage	<b>R7161</b>	Bright Green Flock
Weight 20g		Weight 20g		Weight 20g	
<b>R7162</b>	Medium Green Flock	<b>R7163</b>	Dark Green Flock		
Weight 20g		Weight 20g			

**Accessories**

**R7182** Static Grass Puffer Bottle  
Use with R7183 to apply Static Grasses

**R7183** Grass Glue  
Weight 250g

**Static Grass**

<b>R7177</b>	Spring Meadow, 2.5mm	<b>R7178</b>	Grass Meadow, 2.5mm	<b>R7179</b>	Ornamental Lawn, 2.5mm	<b>R7180</b>	Mixed Summer, 2.5mm	<b>R7181</b>	Alpine Meadow, 2.5mm
Weight 20g		Weight 20g		Weight 20g		Weight 20g		Weight 20g	

R7181 contains bolders

**Lichen**

<b>R7193</b>	Stone Grey	<b>R7194</b>	Green Mix	<b>R7195</b>	Large Green Mix	<b>R7196</b>	Autumn Mix	<b>R7197</b>	Large Autumn Mix
Weight 35g		Weight 35g		Weight 75g		Weight 35g		Weight 75g	

**Foliage**

<b>R7184</b>	Light Green	<b>R7185</b>	Dark Green	<b>R7186</b>	Olive Green
Covering 20x23cm		Covering 20x23cm		Covering 20x23cm	
<b>R7187</b>	Wild Grass (Light Green)	<b>R7188</b>	Wild Grass (Dark Green)	<b>R7189</b>	Yellow Green Meadow
Covering 20x23cm		Covering 20x23cm		Covering 20x23cm	
<b>R7190</b>	Middle Green Meadow	<b>R7191</b>	Leafy - Middle Green	<b>R7192</b>	Leafy - Dark Green
Covering 20x23cm		Covering 20x23cm		Covering 20x23cm	



**R7273** SkaleRoc  
Pack contains: 2 x 10cm x 3mm Rolls



<b>JOUEF</b>	<b>HJ2459/S</b> PAG 34	<b>HJ4189</b> PAG 49	<b>HJ6265</b> PAG 55	<b>ELECTROTREN</b>	<b>HE4035</b> PAG 98	<b>HR2911/D/S</b> PAG 138
<b>HJ2342/S</b> PAG 19	<b>HJ2460/S</b> PAG 35	<b>HJ4190</b> PAG 49	<b>HJ6269</b> PAG 61	<b>HE2008/D/S</b> PAG 82	<b>HE4036</b> PAG 98	<b>HR2912/D/S</b> PAG 140
<b>HJ2417/S</b> PAG 17	<b>HJ2461/S</b> PAG 14	<b>HJ4191</b> PAG 46	<b>HJ6270</b> PAG 61	<b>HE2009/D/S</b> PAG 83	<b>HE6051</b> PAG 104	<b>HR2913/D/S</b> PAG 140
<b>HJ2425/S</b> PAG 24-25	<b>HJ2462/S</b> PAG 15	<b>HJ4192</b> PAG 46	<b>HJ6271</b> PAG 62	<b>HE2012/S</b> PAG 80	<b>HE6052</b> PAG 104	<b>HR2914/S</b> PAG 122
<b>HJ2430/S</b> PAG 10	<b>HJ2463/S</b> PAG 15	<b>HJ4193</b> PAG 47	<b>HJ6272</b> PAG 53	<b>HE2013/S</b> PAG 81	<b>HE6062</b> PAG 105	<b>HR2915/S</b> PAG 122
<b>HJ2431/S</b> PAG 10	<b>HJ2464/S</b> PAG 18	<b>HJ4194</b> PAG 47	<b>HJ6273</b> PAG 53	<b>HE2014/S</b> PAG 81	<b>HE6066</b> PAG 103	<b>HR2916/S</b> PAG 121
<b>HJ2432/S</b> PAG 11	<b>HJ2465/S</b> PAG 18	<b>HJ4195</b> PAG 50	<b>HJ6280</b> PAG 59	<b>HE2016/S</b> PAG 94-95	<b>HE6068</b> PAG 102	<b>HR2920/S</b> PAG 133
<b>HJ2433/S</b> PAG 11	<b>HJ3014</b> PAG 24	<b>HJ4196</b> PAG 43	<b>HJ6281</b> PAG 60	<b>HE2017/S</b> PAG 94-95	<b>HE6070</b> PAG 103	<b>HR2921/S</b> PAG 134
<b>HJ2436/S</b> PAG 16	<b>HJ3015</b> PAG 25	<b>HJ4197</b> PAG 43	<b>HJ6282</b> PAG 60	<b>HE2018/S</b> PAG 86	<b>HE6071</b> PAG 102	<b>HR2923/S</b> PAG 136
<b>HJ2437/S</b> PAG 16	<b>HJ3016</b> PAG 26	<b>HJ4198</b> PAG 37	<b>HJ6287</b> PAG 54	<b>HE2019/S</b> PAG 87	<b>HE6073</b> PAG 103	<b>HR2924/S</b> PAG 136
<b>HJ2438/S</b> PAG 17	<b>HJ3017</b> PAG 27	<b>HJ4199</b> PAG 37	<b>HJ6289</b> PAG 54	<b>HE2020/S</b> PAG 90	<b>HE6077</b> PAG 105	<b>HR2931/S</b> PAG 137
<b>HJ2439/S</b> PAG 23	<b>HJ4168</b> PAG 44	<b>HJ4200</b> PAG 42	<b>HJ6292</b> PAG 51	<b>HE2021/S</b> PAG 91	<b>ELECTROTREN HOBBY</b>	<b>HR2932/S</b> PAG 137
<b>HJ2440/S</b> PAG 23	<b>HJ4169</b> PAG 44	<b>HJ6228</b> PAG 58	<b>HJ6293</b> PAG 51	<b>HE2022/S</b> PAG 91	<b>HE2501A</b> PAG 114	<b>HR2933/S</b> PAG 147
<b>HJ2443/S</b> PAG 28	<b>HJ4170</b> PAG 45	<b>HJ6229</b> PAG 58	<b>HJ6297</b> PAG 62	<b>HE2023/S</b> PAG 84	<b>HE2501B</b> PAG 114	<b>HR2934/S</b> PAG 146
<b>HJ2444/S</b> PAG 29	<b>HJ4171</b> PAG 45	<b>HJ6230</b> PAG 59	<b>JOUEF LOISIRS</b>	<b>HE2024/S</b> PAG 85	<b>HE2503</b> PAG 115	<b>HR2935/S</b> PAG 147
<b>HJ2445/S</b> PAG 29	<b>HJ4173</b> PAG 50	<b>HJ6247</b> PAG 56	<b>HJ2616</b> PAG 72	<b>HE2025/S</b> PAG 85	<b>HE2505</b> PAG 115	<b>HR2936/S</b> PAG 149
<b>HJ2446/S</b> PAG 20	<b>HJ4174</b> PAG 38	<b>HJ6248</b> PAG 57	<b>HJ2617</b> PAG 73	<b>HE4021</b> PAG 99	<b>RIVAROSSI</b>	<b>HR2937/S</b> PAG 149
<b>HJ2447/S</b> PAG 21	<b>HJ4175</b> PAG 39	<b>HJ6249</b> PAG 57	<b>HJ2619</b> PAG 73	<b>HE4027</b> PAG 96	<b>HR2889/S/ACS</b> PAG 124	<b>HR2838/S</b> PAG 152
<b>HJ2448/S</b> PAG 21	<b>HJ4176</b> PAG 40	<b>HJ6250</b> PAG 56	<b>MKD</b>	<b>HE4028</b> PAG 97	<b>HR2890/S/ACS</b> PAG 125	<b>HR2939/S</b> PAG 153
<b>HJ2451/S</b> PAG 26-27	<b>HJ4177</b> PAG 40	<b>HJ6252</b> PAG 63	<b>MKD2020</b> PAG 77	<b>HE4029</b> PAG 100	<b>HR2891/S/ACS</b> PAG 125	<b>HR2940/S</b> PAG 153
<b>HJ2452/S</b> PAG 31	<b>HJ4178</b> PAG 41	<b>HJ6253</b> PAG 63	<b>MKD2021</b> PAG 77	<b>HE4030</b> PAG 100	<b>HR2892/S</b> PAG 126	<b>HR2941/S</b> PAG 150
<b>HJ2453/S</b> PAG 33	<b>HJ4179</b> PAG 41	<b>HJ6255</b> PAG 52	<b>MKD2022</b> PAG 77	<b>HE4031</b> PAG 101	<b>HR2893/S</b> PAG 127	<b>HR2942/S</b> PAG 150
<b>HJ2454/S</b> PAG 33	<b>HJ4187</b> PAG 48	<b>HJ6258</b> PAG 52	<b>MKD2023</b> PAG 77	<b>HE4032</b> PAG 101	<b>HR2909/D/S</b> PAG 139	<b>HR2943/HM</b> PAG 156
<b>HJ2458/S</b> PAG 34	<b>HJ4188</b> PAG 48	<b>HJ6264</b> PAG 55	<b>MKD2024</b> PAG 77	<b>HE4033</b> PAG 99	<b>HR2910/D/S</b> PAG 139	<b>HR2944/HM</b> PAG 156

HR2945/HM	PAG 157	HR3024	PAG 159	HR4383	PAG 183	HR6602	PAG 195	HL2667	PAG 219	HC8037	PAG 229	R643	PAG 230
HR2950/S	PAG 196	HR3025	PAG 160	HR4389	PAG 173	HR6603	PAG 195	HL4674	PAG 215	HC8038	PAG 229	R606	PAG 230
HR2951/S	PAG 197	HR3026	PAG 161	HR4390	PAG 163	HR6612	PAG 187	HL4675	PAG 217	HC8036	PAG 229	R607	PAG 230
HR2952/S	PAG 197	HR4346	PAG 174	HR4391	PAG 163	HR6618	PAG 193	HK4677	PAG 215	HC8040	PAG 227	R608	PAG 230
HR2953/S	PAG 129	HR4347	PAG 175	HR4392	PAG 179	HR6619	PAG 193	HL4678	PAG 217	HC8053	PAG 227	R609	PAG 230
HR2954/S	PAG 131	HR4348	PAG 176	HR4393	PAG 180	HR6620	PAG 192	HL5056	PAG 220	R169	PAG 230	R8261	PAG 230
HR2955/S	PAG 131	HR4349	PAG 168	HR4394	PAG 181	HR6621	PAG 192	HL5057	PAG 220	R610	PAG 230	R8262	PAG 230
HR2956/S	PAG 123	HR4350	PAG 177	HR4395	PAG 177	HR6622	PAG 193	HL5058	PAG 221	R600	PAG 230	R628	PAG 230
HR2957/S	PAG 123	HR4360	PAG 164	HR4397	PAG 176	HR6624	PAG 190	HEICO		R601	PAG 230	R087	PAG 230
HR2958/S/ACS	PAG 154	HR4361	PAG 165	HR4399	PAG 172	HR6625	PAG 190	HC2100	PAG 225	R603	PAG 230	R617	PAG 231
HR2959/S/ACS	PAG 155	HR4362	PAG 165	HR4400	PAG 172	HR6645	PAG 191	HC2103	PAG 225	R614	PAG 230	R620	PAG 231
HR2960/S/ACS	PAG 155	HR4365	PAG 170	HR6546	PAG 191	HR6646	PAG 191	HC2104	PAG 224	R615	PAG 230	R8244	PAG 231
HR2961/S	PAG 151	HR4366	PAG 170	HR6547	PAG 191	HR6647	PAG 187	ACCESSORIES		R8076	PAG 230	R910	PAG 231
HR2962/S	PAG 159	HR4367	PAG 171	HR6552	PAG 186	HR6661A/B/C/D	PAG 198	HC6100	PAG 226	R8072	PAG 230	R920	PAG 231
HR2963/S	PAG 160	HR4368	PAG 171	HR6553	PAG 186	HR6662A/B/C/D	PAG 198	HC6101	PAG 226	R8073	PAG 230	R207	PAG 231
HR2964/S	PAG 161	HR4373	PAG 178	HR6555	PAG 188	HR6663A/B/C/D	PAG 199	HC6102	PAG 226	R8074	PAG 230	R626	PAG 231
HR2965/S	PAG 144	HR4374	PAG 166	HR6558	PAG 188	HR6664A/B/C/D	PAG 199	HC6103	PAG 226	R8075	PAG 230	R638	PAG 231
HR2966/S	PAG 144	HR4375	PAG 167	HR6589	PAG 189	HR6665A/B/C/D	PAG 199	HC6104	PAG 226	R8077	PAG 230	R8098	PAG 231
HR2967/S	PAG 144	HR4376	PAG 168	HR6590	PAG 189	LIMA EXPERT		HC6105	PAG 226	R8078	PAG 228	R8097	PAG 231
HR2968/S	PAG 144	HR4377	PAG 169	HR6597	PAG 185	HL1750	PAG 214	HC8006	PAG 228	R618	PAG 230	R8096	PAG 231
HR2969/S	PAG 134	HR4378	PAG 169	HR6598	PAG 185	HL1751	PAG 216	HC8007	PAG 228	R621	PAG 230	R8218	PAG 231
HR2970/D	PAG 141	HR4380	PAG 182	HR6599	PAG 184	HL2663	PAG 218	HC8034	PAG 228	R8090	PAG 230	R8264	PAG 231
HR2971/D	PAG 141	HR4381	PAG 182	HR6600	PAG 194	HL2664	PAG 218	HC8035	PAG 228	R604	PAG 230	R8234	PAG 231
HR2972/S	PAG 135	HR4382	PAG 183	HR6601	PAG 195	HL2665	PAG 219	HC8036	PAG 229	R605	PAG 230	R8100	PAG 231



R913	PAG 231	R406	PAG 231	P9100	PAG 233	SD012	PAG 235	<b>BUILDINGS &amp; TRACKS</b>	R514	PAG 237	R8511	PAG 238	
R8268	PAG 231	R172	PAG 231	HM7000	PAG 234	SD013	PAG 235	R8217	PAG 236	R334	PAG 237	R8544	PAG 238
R8220	PAG 231	R169	PAG 231	HM6000	PAG 234	SD014	PAG 235	R8227	PAG 236	R464	PAG 237	R8545	PAG 238
R8267	PAG 231	R170	PAG 231	R7377	PAG 235	SD015	PAG 235	R8228	PAG 236	R463	PAG 237	R8510	PAG 238
R8219	PAG 231	R8213	PAG 232	R7326	PAG 235	SD016	PAG 235	R8229	PAG 236	R460	PAG 237	R8512	PAG 238
R8099	PAG 231	R8214	PAG 232	R7336	PAG 235	SD017	PAG 235	R8230	PAG 236	R462	PAG 237	R8526	PAG 238
R7200	PAG 231	R8247	PAG 232	R7324	PAG 235	SD018	PAG 235	R8231	PAG 236	R8005	PAG 237	R8527	PAG 238
R7398	PAG 231	R7274	PAG 232	R7321	PAG 235	SD019	PAG 235	R574	PAG 236	R8003	PAG 237	R8538	PAG 238
R7399	PAG 231	R7150	PAG 232	R7335	PAG 235	SD020	PAG 235	R8221	PAG 236	R8004	PAG 237	R8539	PAG 238
R7400	PAG 231	R8249	PAG 232	R7322	PAG 235	SD021	PAG 235	R8222	PAG 236	R8002	PAG 237	R8540	PAG 238
R8211	PAG 231	R7401	PAG 232	R7345	PAG 235	SD022	PAG 235	R8223	PAG 236	R8006	PAG 237	R8541	PAG 238
R8012	PAG 231	R7402	PAG 232	R7327	PAG 235	SD023	PAG 235	R8224	PAG 236	R530	PAG 237	R8977	PAG 238
R9001	PAG 231	R7382	PAG 232	R7337	PAG 235	SD024	PAG 235	R8225	PAG 236	R645	PAG 237	R8978	PAG 238
R7229	PAG 231	R8241	PAG 232	SD001	PAG 235	SD025	PAG 235	R8226	PAG 236	R636	PAG 237	R8979	PAG 238
R8206	PAG 231	R8232	PAG 232	SD002	PAG 235	SD026	PAG 235	R8009	PAG 237	R658	PAG 237	R7115	PAG 238
R602	PAG 231	R8242	PAG 232	SD003	PAG 235	SD027	PAG 235	R590	PAG 237	R659	PAG 237	R7116	PAG 238
R8201	PAG 231	R7305	PAG 232	SD004	PAG 235	SD028	PAG 235	R513	PAG 237	R909	PAG 237	R7117	PAG 238
R8015	PAG 231	R7338	PAG 232	SD005	PAG 235	SD029	PAG 235	R8000	PAG 237	R660	PAG 237	R7118	PAG 238
R044	PAG 231	R7293	PAG 233	SD006	PAG 235	SD030	PAG 235	R083	PAG 235	R537	PAG 237	R7119	PAG 238
R046	PAG 231	R7292	PAG 233	SD007	PAG 235	SD031	PAG 235	R394	PAG 237	R070	PAG 237	R7120	PAG 238
R047	PAG 231	HT8300	PAG 233	SD008	PAG 235	SD032	PAG 235	R8007	PAG 237	R189	PAG 237	R7121	PAG 238
R171	PAG 231	HT8301	PAG 233	SD009	PAG 235	SD033	PAG 235	R8001	PAG 237	R180	PAG 237	R7122	PAG 238
R8014	PAG 231	HT8302	PAG 233	SD010	PAG 235	SD034	PAG 235	R076	PAG 237	R8008	PAG 237	R8614	PAG 239
R8243	PAG 231	HT8304	PAG 233	SD011	PAG 235	SD035	PAG 235	R510	PAG 237	R8509	PAG 238	R7304	PAG 239

R8615	PAG 239	R7204	PAG 240	R7225	PAG 240	R7195	PAG 241			
R7285	PAG 239	R7205	PAG 240	R7226	PAG 240	R7196	PAG 241			
R7287	PAG 239	R7206	PAG 240	R7227	PAG 240	R7197	PAG 241			
R7286	PAG 239	R7207	PAG 240	R7228	PAG 240	R7156	PAG 241			
R7371	PAG 239	R7208	PAG 240	R7164	PAG 241	R7157	PAG 241			
R7370	PAG 239	R7209	PAG 240	R7165	PAG 241	R7158	PAG 241			
R8674	PAG 239	R7210	PAG 240	R7166	PAG 241	R7159	PAG 241			
R8673	PAG 239	R7211	PAG 240	R7167	PAG 241	R7160	PAG 241			
R7373	PAG 239	R7198	PAG 240	R7168	PAG 241	R7161	PAG 241			
R7375	PAG 239	R7201	PAG 240	R7169	PAG 241	R7162	PAG 241			
R7387	PAG 239	R7199	PAG 240	R7170	PAG 241	R7163	PAG 241			
R7389	PAG 239	R7212	PAG 240	R7171	PAG 241	R7184	PAG 241			
R7385	PAG 239	R7213	PAG 240	R7172	PAG 241	R7185	PAG 241			
R7368	PAG 239	R7214	PAG 240	R7173	PAG 241	R7186	PAG 241			
R7367	PAG 239	R7215	PAG 240	R7174	PAG 241	R7187	PAG 241			
R7374	PAG 239	R7216	PAG 240	R7175	PAG 241	R7188	PAG 241			
R7386	PAG 239	R7217	PAG 240	R7176	PAG 241	R7189	PAG 241			
R7388	PAG 239	R7218	PAG 240	R7177	PAG 241	R7190	PAG 241			
R7372	PAG 239	R7219	PAG 240	R7178	PAG 241	R7191	PAG 241			
R7384	PAG 239	R7220	PAG 240	R7179	PAG 241	R7192	PAG 241			
R7390	PAG 239	R7221	PAG 240	R7180	PAG 241	R7182	PAG 241			
<b>SKALE SCENICS</b>		R7222	PAG 240	R7181	PAG 241	R7183	PAG 241			
R7202	PAG 240	R7223	PAG 240	R7193	PAG 241	R7273	PAG 241			
R7203	PAG 240	R7224	PAG 240	R7194	PAG 241					



© Hornby Hobbies Ltd.

**HORNBY HOBBIES LTD**

Westwood, Margate, Kent, CT9 4JX, UK

**EU Authorised Representative:**

Hornby Italia SRL  
Viale dei Caduti, 52/A6, Castel Mella  
(BS), Italy, 25030

[www.jouef.com](http://www.jouef.com)  
[www.electrotren.com](http://www.electrotren.com)  
[www.rivarossi.com](http://www.rivarossi.com)  
[www.limamodel.com](http://www.limamodel.com)



/JOUEF  
/Electrotren  
/rivarossi.model  
/lima.models



@hornbyinternational

**DE 08000.00.26.27**  
Customerservices.de@hornby.com  
Technicalservices.de@hornby.com

**ES 900.67.03.41**  
Customerservices.es@hornby.com  
Technicalservices.es@hornby.com

**FR 801.87.00.06**  
Customerservices.fr@hornby.com  
Technicalservices.fr@hornby.com

**IT 800.01.98.50**  
Customerservices.it@hornby.com  
Technicalservices.it@hornby.com

**UK +44 (0)1843 233525**  
Customerservices.uk@hornby.com  
Technicalservices.uk@hornby.com



HP2024H0